

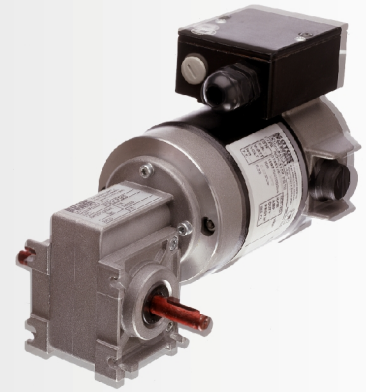

# ROK

This series of worm gearmotors is assembled to continuous and alternating current motors. Thanks to the direct coupling ROK series introduces objective performance advantages in comparison with a classic configuration motor-gearboxes.



<b>Gearmotor Model</b>	<b>Power Watt</b>	<b>Input Speed (Rpm)</b>	<b>Voltage (Vdc)</b>	<b>Ratio</b>	<b>Max Torque (Nm)</b>
ROK 311 S	45	3000	24÷48	7÷100	10
ROK 311 M	70				
ROK 311 L	90				
ROK 315 X	100	3000	24÷180	7÷100	10
ROK 315 XS	150				
ROK 315 S	200				
ROK 335 XS	150	3000	24÷180	7÷100	10
ROK 335 S	200			7÷75	13
ROK 335 SL	300				

Gearboxes dimension gauge 31mm and 33mm

Aluminium case gearbox, bronze-silver wheel and ground worm in steel

Extremely long-life and wearing resistant

# ROK 311

**TABELLA DI DEFINIZIONE SIGLA DI ORDINE PER MOTORIDUTTORI SERIE ROK 311**  
**HOW TO ORDER A ROK 311 WORMGEARMOTOR**

ROK	311M	30	48	01.04....	B	P.B10	07	A1
SERIE SERIES	TIPO TYPE	VELOCITA' MOTORE MOTOR SPEED	TENSIONE MOTORE MOTOR VOLTAGE	OPZIONI OPTIONS	VERSIONE MOTORE MOTOR VERSION	TIPO DI RIDUTTORE WORMGEAR TYPE	RAPPORTO DI RIDUZIONE RATIO	CONFIGU- RAZIONE CONFIGU- RATION
ROK	311S 311M 311L	30	24 48	<b>01-</b> Dinamo tachimetrica <i>Tacho generator</i>  <b>02-</b> Freno 0.5 Nm <i>Brake 0.5 Nm</i>  <b>03-</b> Freno 0.5 Nm + din. tachim. <i>Tacho gen.+ brake 0.5 Nm</i>  <b>04-</b> Uscita cavi 2P 1m <i>Flying leads 2P 1m</i>  <b>05-</b> Uscita cavi 2P 1m + D.T. <i>Tacho gen. + flying leads 2P 1m</i>  <b>06-</b> Past. Termica (solo morset.) <i>Thermal cut-out (only on terminal box version)</i>  <b>07-</b> Protezione IP55 <i>IP55</i>  <b>08-</b> Pred. encoder EH38 <i>EH38 encoder prearrangement</i>  <b>09-</b> Pred. encoder EH53 <i>EH53 encoder prearrangement</i>  <b>10-</b> Distanziale encoder n°1 <i>Encoder spacer n°1</i>  <b>11-</b> Morsettiera <i>Terminal box</i>	<b>B</b> : Base Basic	P.B10 P.K14 FQ1.K14.DX FQ1.B10.DX FT1.S12.DX P1.K14	07 10 12 15 18 24 30 38 55 75 100	A1 C1 E1 G1

SERIE-Series

# ROK 311S

<b>WATT</b> Motore-motor <b>45</b>	<b>Nm</b> Riduttore-gear <b>10</b>
--	--

## CARATTERISTICHE GENERALI - Performance characteristics

MOTORE Motor		POTENZA - Power 45 W				VELOCITA' - Speed 3000 RPM				COPPIA - Torque 0.14 Nm			
<b>RAPPORTO RIDUZIONE</b> Ratio	I:	7	10	12	15	18	24	30	38	55	75	100*	
<b>VELOCITA' USCITA</b> Output speed	RPM	429	300	250	200	167	125	100	79	55	40	30*	
<b>COPPIA NOMINALE</b> Rated Torque	Nm	0.8	1	1.2	1.5	1.7	1.6	2	2.5	3.1	2.8	4	
<b>COPPIA MASSIMA</b> Max. Torque	Nm-max.	(A) (B)	9.7 14.5	9.5 14.2	12.1 18	10.7 16	10.3 15.5	9.2 13.8	10.3 15.4	11.4 17.1	10.4 15.6	7.3 12	7.4 12
<b>TENSIONE NOMINALE</b> Rated Voltage	VOLT	48	24	(2)									
<b>CORRENTE NOMINALE</b> Rated Current	AMP	1.3	2.6										
<b>RESIST. ARMATURA</b> Armature resistance	Ohm	6.3	1.33										
<b>INDUTT. ARMATURA</b> Armature inductance	mH	9	2										
<b>COST. TENSIONE</b> Voltage constant	Ke V/Krpm	13	6.4										
<b>COST. TEMPO ELETT.</b> Elect. time constant	Te ms	1.5	1.5										
<b>COST. TEMPO MECC.</b> Mech. time constant	Tm ms	6	5										
<b>COST. TEMPO TERMICO</b> Thermal time constant	Tt min	20	20										

\* Solo su richiesta only by request (2) Altre tensioni a richiesta-other voltages by request (A) Coppia massima riduttore continuativa (A) Max. gear continuous torque (B) Massima coppia impulsiva riduttore (B) Max. gear pulse torque

### DATI MECCANICI - Mechanical data

<b>CARICO RADIALE</b> Radial Load	N	120
<b>CARICO ASSIALE</b> Axial Load	N	80
<b>PESO MOTORIDUTTORE</b> Gearmotor weight	Kg	1.7
<b>LUBRIFICAZIONE</b> Lubrication	<b>GRASSO</b> Long life grease	
<b>CORONA</b> Worm	<b>BRONZO</b> Bronze	
<b>VITE</b> Screw	<b>ACCIAIO</b> Steel	

### DATI ELETTRICI - Winding data

<b>CLASSE ISOLAMENTO</b> Insulation class	F	
<b>FATTORE DI SERVIZIO</b> Duty cycle	S1	
<b>FATTORE DI FORMA</b> Form Factor	FF	1
<b>TEMPERATURA AMBIENTE</b> Room temperature	T rif °C	40°
<b>GRADO DI PROTEZIONE</b> Protection	IP	54
<b>INERZIA ROTORE</b> Rotor inertia	Jm Kgcm <sup>2</sup>	0.28

# ROK311S

DIMENSIONI (mm)

DIMENSIONS (mm)



**B \***

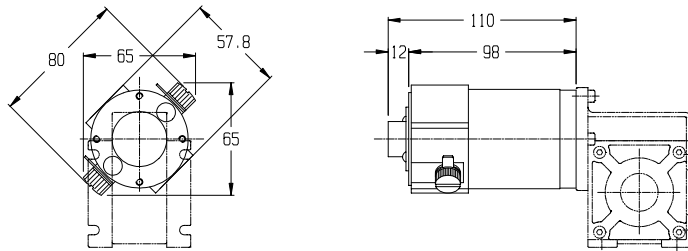

Vista frontale

Front view

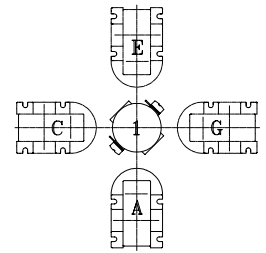

Configurazione

Configuration

**\* P.B10**

STD Config. **A1**

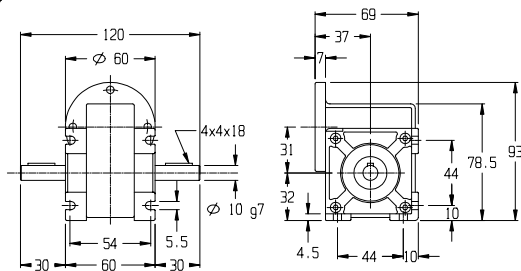

**\* P.K14**

STD Config. **A1**

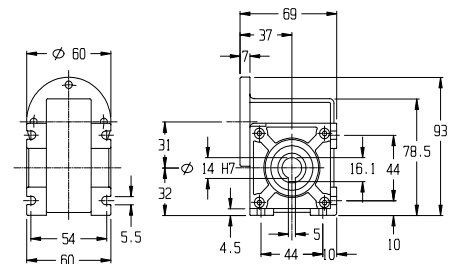

**\* FQ1.K14.DX**

STD Config. **A1**

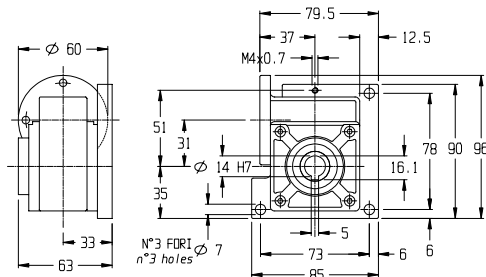

**\* FQ1.B10.DX**

STD Config. **A1**

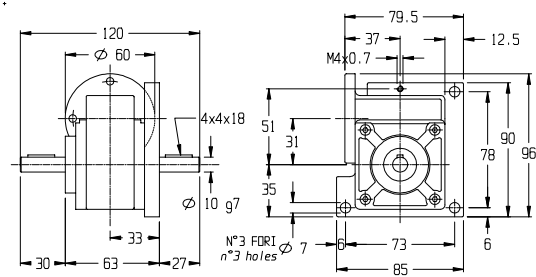

**\* FT1.S12.DX**

STD Config. **A1**

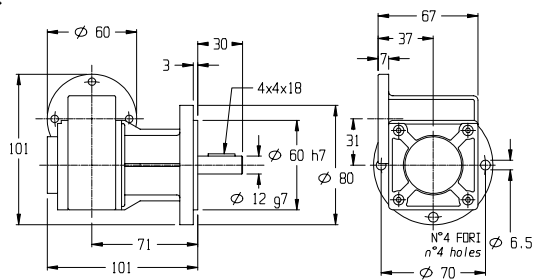

**\* P1.K14**

STD Config. **A1**

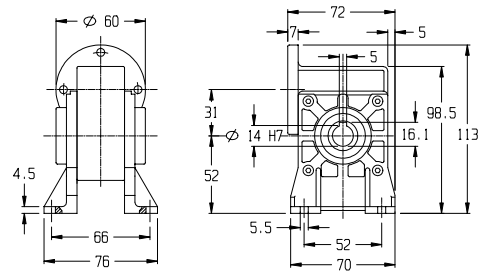

Accoppiare motore e riduttore contrassegnati dallo stesso segno \* / \*\*

Fitting motor and gear box marked with the same symbol \* / \*\*

SERIE-Series

# ROK 311M

<b>WATT</b> Motore-motor <b>70</b>	<b>Nm</b> Riduttore-gear <b>10</b>
--	--

## CARATTERISTICHE GENERALI - Performance characteristics

MOTORE <i>Motor</i>		POTENZA - Power 70 W				VELOCITA - Speed 3000 RPM				COPPIA - Torque 0.22 Nm			
<b>RAPPORTO RIDUZIONE</b> <i>Ratio</i>	I:	<b>7</b>	<b>10</b>	<b>12</b>	<b>15</b>	<b>18</b>	<b>24</b>	<b>30</b>	<b>38</b>	<b>55</b>	<b>75</b>	<b>100*</b>	
<b>VELOCITA USCITA</b> <i>Output speed</i>	RPM	429	300	250	200	167	125	100	79	55	40	30*	
<b>COPPIA NOMINALE</b> <i>Rated Torque</i>	Nm	1.2	1.5	1.8	2.2	2.6	2.5	3.1	3.8	4.8	4.3	6.2	
<b>COPPIA MASSIMA</b> <i>Max. Torque</i>	Nm-max.	(A)	9.7	9.5	12.1	10.7	10.3	9.2	10.3	11.4	10.4	7.3	7.4
		(B)	14.5	14.2	18	16	15.5	13.8	15.4	17.1	15.6	12	12
<b>TENSIONE NOMINALE</b> <i>Rated Voltage</i>	VOLT	48	24					(2)					
<b>CORRENTE NOMINALE</b> <i>Rated Current</i>	AMP	1.95	3.65										
<b>RESIST. ARMATURA</b> <i>Armature resistance</i>	Ohm	2.33	0.85										
<b>INDUTT. ARMATURA</b> <i>Armature inductance</i>	mH	4	1.34										
<b>COST. TENSIONE</b> <i>Voltage constant</i>	Ke V/Krpm	13.2	7.3										
<b>COST. TEMPO ELETT.</b> <i>Elect. time constant</i>	Te ms	1.7	1.58										
<b>COST. TEMPO MECC.</b> <i>Mech. time constant</i>	Tm ms	6.5	6										
<b>COST. TEMPO TERMICO</b> <i>Thermal time constant</i>	Tt min	25	25										

\* Solo su richiesta only by request (2) Altre tensioni a richiesta-other voltages by request (A) Coppia massima riduttore continuativa (A) Max. gear continuous torque (B) Massima coppia impulsiva riduttore (B) Max. gear pulse torque

### DATI MECCANICI - Mechanical data

<b>CARICO RADIALE</b> <i>Radial Load</i>	N	120
<b>CARICO ASSIALE</b> <i>Axial Load</i>	N	80
<b>PESO MOTORIDUTTORE</b> <i>Gearmotor weight</i>	Kg	2
<b>LUBRIFICAZIONE</b> <i>Lubrication</i>		<b>GRASSO</b> Long life grease
<b>CORONA</b> <i>Worm</i>		<b>BRONZO</b> Bronze
<b>VITE</b> <i>Screw</i>		<b>ACCIAIO</b> Steel

### DATI ELETTRICI - Winding data

<b>CLASSE ISOLAMENTO</b> <i>Insulation class</i>		F
<b>FATTORE DI SERVIZIO</b> <i>Duty cycle</i>		S1
<b>FATTORE DI FORMA</b> <i>Form Factor</i>	FF	1
<b>TEMPERATURA AMBIENTE</b> <i>Room temperature</i>	T rif °C	40°
<b>GRADO DI PROTEZIONE</b> <i>Protection</i>	IP	54
<b>INERZIA ROTORE</b> <i>Rotor inertia</i>	Jm Kgcm <sup>2</sup>	0.47

# ROK311M

DIMENSIONI (mm)

DIMENSIONS (mm)



**B \***

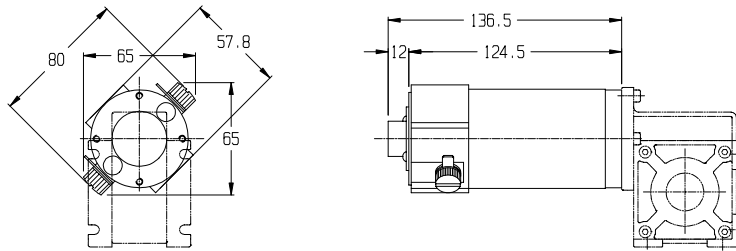

Vista frontale

Front view

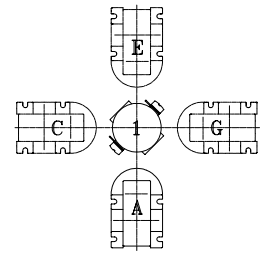

Configurazione

Configuration

**\* P.B10**

STD Config. **A1**

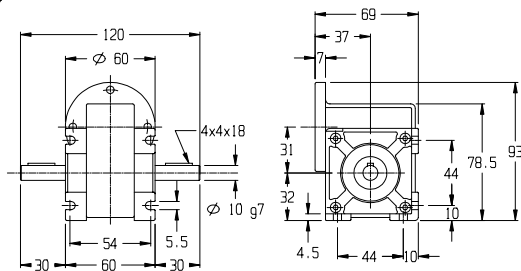

**\* P.K14**

STD Config. **A1**

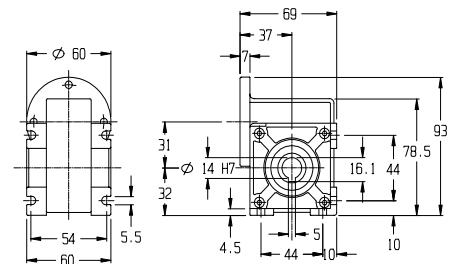

**\* FQ1.K14.DX**

STD Config. **A1**

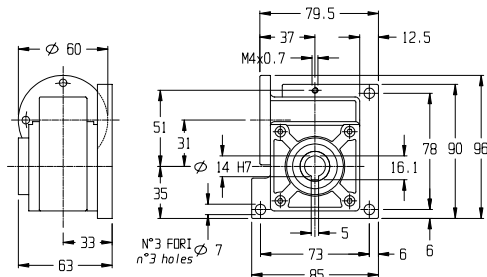

**\* FQ1.B10.DX**

STD Config. **A1**

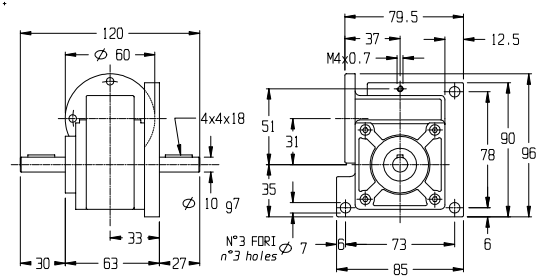

**\* FT1.S12.DX**

STD Config. **A1**

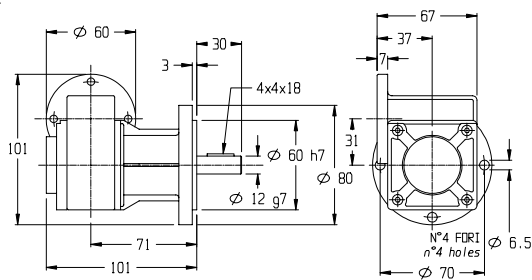

**\* P1.K14**

STD Config. **A1**

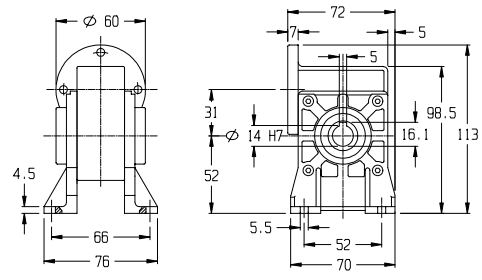

Accoppiare motore e riduttore contrassegnati dallo stesso segno \* / \*\*

Fitting motor and gear box marked with the same symbol \* / \*\*

SERIE-Series

# ROK 311L

<b>WATT</b> Motore-motor <b>95</b>	<b>Nm</b> Riduttore-gear <b>10</b>
--	--

## CARATTERISTICHE GENERALI - Performance characteristics

MOTORE Motor		POTENZA - Power 95 W				VELOCITA - Speed 3000 RPM				COPPIA - Torque 0.3 Nm			
<b>RAPPORTO RIDUZIONE</b> Ratio	I:	7	10	12	15	18	24	30	38	55	75	100*	
<b>VELOCITA USCITA</b> Output speed	RPM	429	300	250	200	167	125	100	79	55	40	30*	
<b>COPPIA NOMINALE</b> Rated Torque	Nm	1.6	2	2.5	3.1	3.6	3.5	4.2	5.2	6.6	5.9	7.4	
<b>COPPIA MASSIMA</b> Max. Torque	Nm-max.	(A) (B)	9.7 14.5	9.5 14.2	12.1 18	10.7 16	10.3 15.5	9.2 13.8	10.3 15.4	11.4 17.1	10.4 15.6	7.3 12	7.4 12
<b>TENSIONE NOMINALE</b> Rated Voltage	VOLT	48	24	(2)									
<b>CORRENTE NOMINALE</b> Rated Current	AMP	2.5	4.9										
<b>RESIST. ARMATURA</b> Armature resistance	Ohm	2.43	0.48										
<b>INDUTT. ARMATURA</b> Armature inductance	mH	3	0.7										
<b>COST. TENSIONE</b> Voltage constant	Ke V/Krpm	13.3	7.5										
<b>COST. TEMPO ELETT.</b> Elect. time constant	Te ms	1.24	1.46										
<b>COST. TEMPO MECC.</b> Mech. time constant	Tm ms	9	6										
<b>COST. TEMPO TERMICO</b> Thermal time constant	Tt min	30	30										

\* Solo su richiesta only by request (2) Altre tensioni a richiesta-other voltages by request (A) Coppia massima riduttore continuativa (A) Max. gear continuous torque (B) Massima coppia impulsiva riduttore (B) Max. gear pulse torque

### DATI MECCANICI - Mechanical data

<b>CARICO RADIALE</b> Radial Load	N	120
<b>CARICO ASSIALE</b> Axial Load	N	80
<b>PESO MOTORIDUTTORE</b> Gearmotor weight	Kg	2.6
<b>LUBRIFICAZIONE</b> Lubrication	<b>GRASSO</b> Long life grease	
<b>CORONA</b> Worm	<b>BRONZO</b> Bronze	
<b>VITE</b> Screw	<b>ACCIAIO</b> Steel	

### DATI ELETTRICI - Winding data

<b>CLASSE ISOLAMENTO</b> Insulation class	F	
<b>FATTORE DI SERVIZIO</b> Duty cycle	S1	
<b>FATTORE DI FORMA</b> Form Factor	FF	1
<b>TEMPERATURA AMBIENTE</b> Room temperature	T rif °C	40°
<b>GRADO DI PROTEZIONE</b> Protection	IP	54
<b>INERZIA ROTORE</b> Rotor inertia	Jm Kgcm <sup>2</sup>	0.9



# ROK311L

DIMENSIONI (mm)

DIMENSIONS (mm)



**B \***

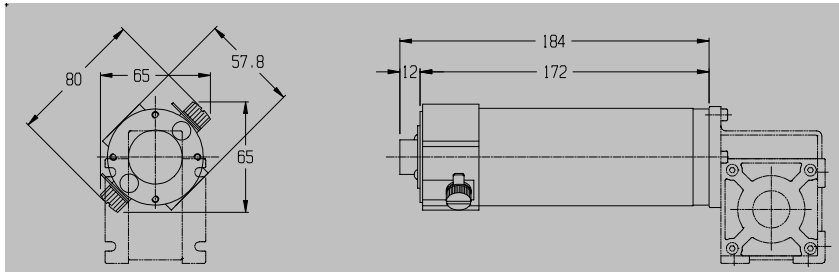

Vista frontale

Front view

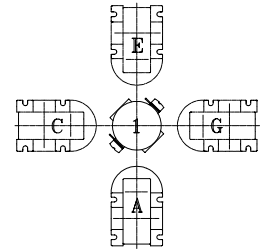

Configurazione

Configuration

**\* P.B10**

STD Config. A1

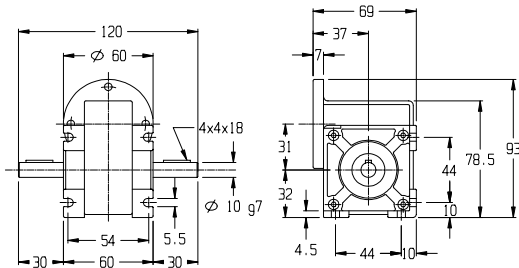

**\* P.K14**

STD Config. A1

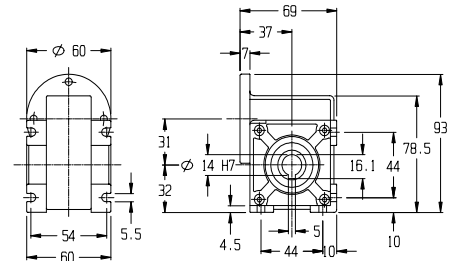

**\* FQ1.K14.DX**

STD Config. A1

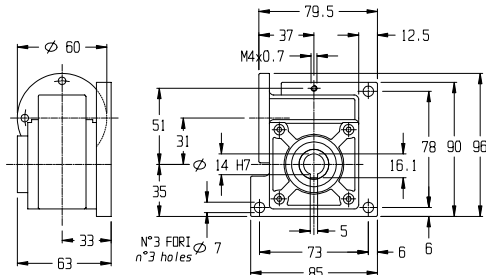

**\* FQ1.B10.DX**

STD Config. A1

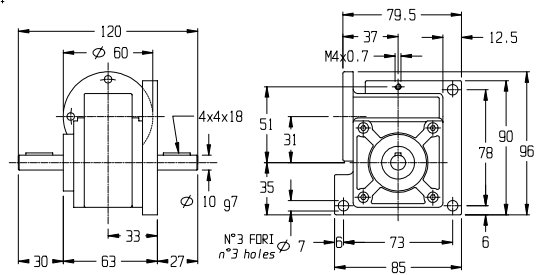

**\* FT1.S12.DX**

STD Config. A1

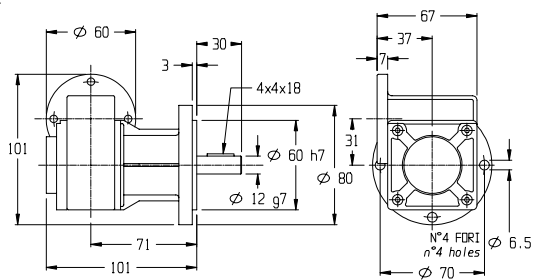

**\* P1.K14**

STD Config. A1

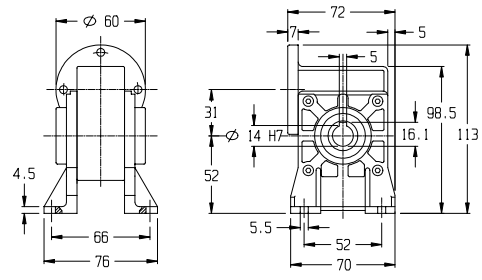

Accoppiare motore e riduttore contrassegnati dallo stesso segno \* / \*\*

Fitting motor and gear box marked with the same symbol \* / \*\*

# ROK311

OPTIONALS (mm)

## DINAMO TACHIMETRICA 01 TACHO GENERATOR

\* cavo schermato L=1m  
shielded cable L=1m

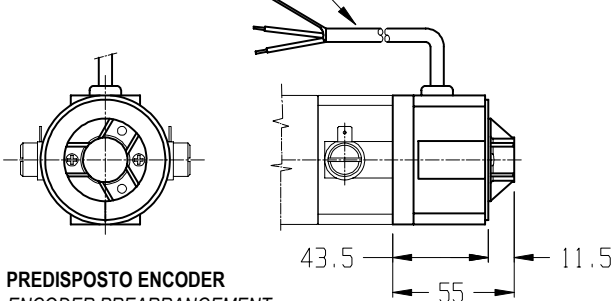

● PREDISPOSTO ENCODER  
ENCODER PREARRANGEMENT

COSTANTE DI TENSIONE VOLTAGE CONSTANT	10±5% V/KRPM	CORRENTE NOMINALE RATED CURRENT	2 mA
VELOCITA' MASSIMA MAX SPEED	9000 RPM	CORRENTE MASSIMA MAX CURRENT	8 mA

## FRENO 0.5 Nm 02 BRAKE 0.5 Nm

\* n°2 cavi 0.5\*1m  
n°2 cables 0.5\*1m

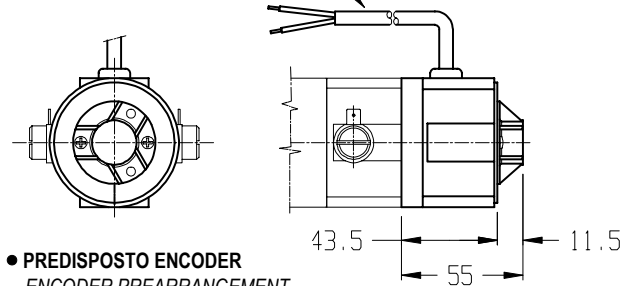

● PREDISPOSTO ENCODER  
ENCODER PREARRANGEMENT

COPPIA STATICA STATIC TORQUE	0.5 Nm	CORRENTE CURRENT	0.42 A
TENSIONE DI ALIMEN. POWER SUPPLY VOLTAGE	24 V.c.c.	POTENZA ASSORBITA INPUT POWER	10 W

## FRENO 0.5 Nm + DIN. TACHIMETRICA 03 TACHO GENERATOR + BRAKE 0.5 Nm

\* n°2 cavi 0.5\*1m  
n°2 cables 0.5\*1m

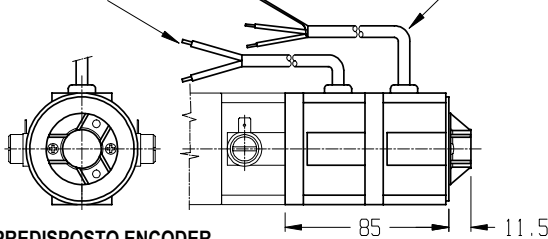

● PREDISPOSTO ENCODER  
ENCODER PREARRANGEMENT

FRENO	BRAKE	DINAMO T.	TACHO G.
COPPIA STATICA STATIC TORQUE	0.5 Nm	COSTANTE DI TENSIONE VOLTAGE CONSTANT	10±5% V/KRPM
TENSIONE DI ALIMEN. POWER SUPPLY VOLTAGE	24 V.c.c.	VELOCITA' MASSIMA MAX SPEED	9000 RPM
CORRENTE CURRENT	0.42 A	CORRENTE NOMINALE RATED CURRENT	2 mA
POTENZA ASSORBITA INPUT POWER	10 W	CORRENTE MASSIMA MAX CURRENT	8 mA

## CAVO + DINAMO TACHIMETRICA 05 TACHO GENERATOR + FLYING LEADS

\* cavo AF 2\*1.5\*1m  
cable 2\*1.5\*1m

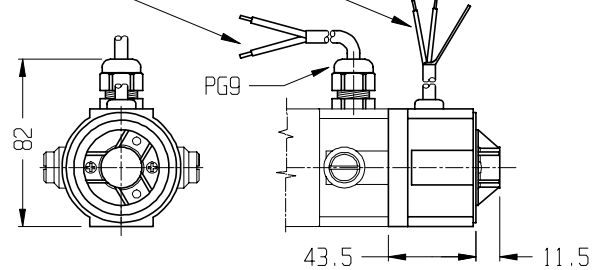

● PREDISPOSTO ENCODER  
ENCODER PREARRANGEMENT

COSTANTE DI TENSIONE VOLTAGE CONSTANT	10±5% V/KRPM	CORRENTE NOMINALE RATED CURRENT	2 mA
VELOCITA' MASSIMA MAX SPEED	9000 RPM	CORRENTE MASSIMA MAX CURRENT	8 mA

## CAVO 04 FLYING LEADS

\* cavo AF 2\*1.5\*1m  
cable 2\*1.5\*1m

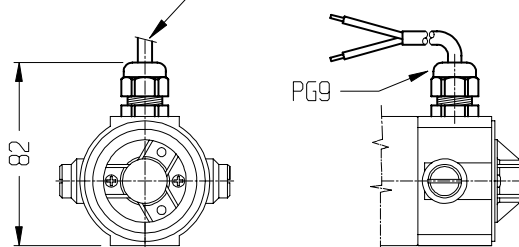

## PREDISPOSIZIONE ENCODER 06 ENCODER PREARRANGEMENT

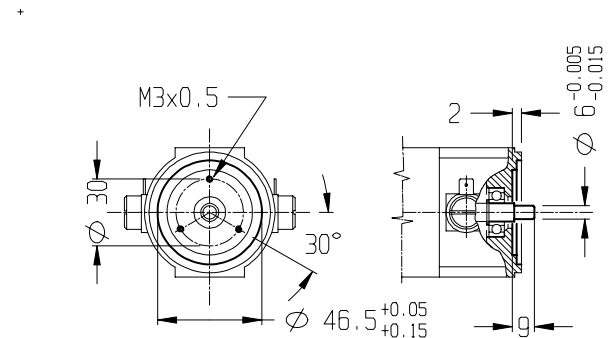

# ROK311

## OPTIONALS (mm)

**ENCODER EH38**

**08**

*EH38 ENCODER*

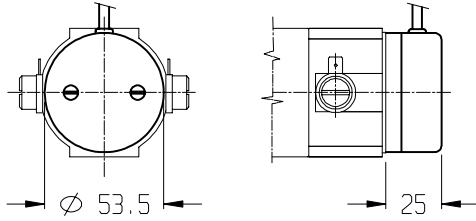

**ENCODER EH53**

**09**

*EH53 ENCODER*

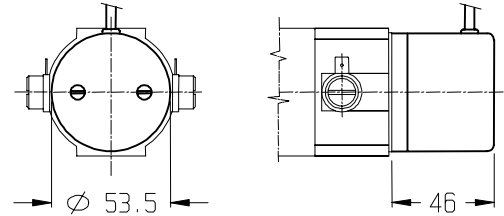

**DISTANZIALE  
ENCODER N°1**

**10**

*ENCODER  
SPACER N°1*

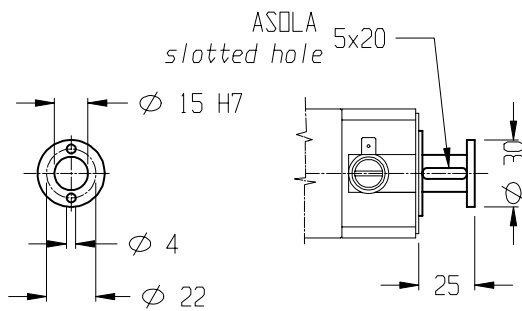

**MORSETTIERA**

**11**

*TERMINAL BOX*

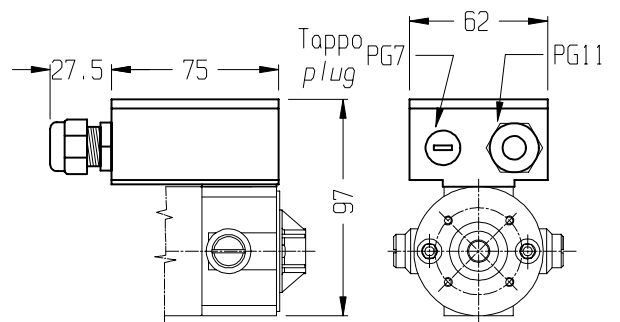

# ROK 315

**TABELLA DI DEFINIZIONE SIGLA DI ORDINE PER MOTORIDUTTORI SERIE ROK 315**  
**HOW TO ORDER A ROK 315 WORMGEARMOTOR**

ROK	315S	30	48	01.04....	B	P.B10	07	A1
SERIE SERIES	TIPO TYPE	VELOCITA' MOTORE MOTOR SPEED	TENSIONE MOTORE MOTOR VOLTAGE	OPZIONI OPTIONS	VERSIONE MOTORE MOTOR VERSION	TIPO DI RIDUTTORE WORMGEAR TYPE	RAPPORTO DI RIDUZIONE RATIO	CONFIGU- RAZIONE CONFIGU- RATION
ROK	315X 315XS 315S	30	24 48 60 90 180	<b>01-</b> Dinamo tachimetrica <i>Tacho generator</i> <b>04-</b> Uscita cavi 2P 0.5m <i>Flying leads 2P 0.5m</i> <b>05-</b> Uscita cavi 2P 0.5m + D.T. <i>Tacho g. + flying leads 2P 0.5m</i> <b>06-</b> Past. Termica (solo morset.) <i>Thermal cut-out (only on terminal box version)</i> <b>07-</b> Protezione IP55 <i>IP55</i> <b>08-</b> Pred. encoder EH38 <i>EH38 encoder prearrangement</i> <b>09-</b> Pred. encoder EH53 <i>EH53 encoder prearrangement</i> <b>10-</b> Distanziale encoder n°1 <i>Encoder spacer n°1</i> <b>11-</b> Distanziale encoder n°2 <i>Encoder spacer n°2</i> <b>15-</b> Freno 1.7 Nm <i>Brake 1.7 Nm</i> <b>16-</b> Freno 1.7 Nm + din. tachimet. <i>Tacho gen. + brake 1.7 Nm</i>	<b>B</b> : Base <i>Basic</i>  <b>P</b> : Piedi <i>Foot mounting</i>	B.B10 B.K14 P.B10 P.K14 FT1.S12.DX P1.K14	07 10 12 15 18 24 30 38 55 75 100	A1 B1 C1 D1 E1 F1 G1 H1

SERIE-Series

# ROK 315X

<b>WATT</b> Motore-motor <b>100</b>	<b>Nm</b> Riduttore-gear <b>10</b>
---	--

## CARATTERISTICHE GENERALI - Performance characteristics

MOTORE Motor		POTENZA - Power 100 W					VELOCITA - Speed 3000 RPM				COPPIA - Torque 0.32 Nm		
<b>RAPPORTO RIDUZIONE</b> Ratio	I:	<b>7</b>	<b>10</b>	<b>12</b>	<b>15</b>	<b>18</b>	<b>24</b>	<b>30</b>	<b>38</b>	<b>55</b>	<b>75</b>	<b>100*</b>	
<b>VELOCITA USCITA</b> Output speed	RPM	429	300	250	200	167	125	100	79	55	40	30*	
<b>COPPIA NOMINALE</b> Rated Torque	Nm	1.7	2.2	2.6	3.3	3.8	3.7	4.5	5.6	7	6.2	7.4	
<b>COPPIA MASSIMA</b> Max. Torque	Nm-max.	(A) (B)	9.7 14.5	9.5 14.2	12.1 18	10.7 16	10.3 15.5	9.2 13.8	10.3 15.4	11.4 17.1	10.4 15.6	7.3 12	7.4 12
<b>TENSIONE NOMINALE</b> Rated Voltage	VOLT	180	90	60	48	24	(2)						
<b>CORRENTE NOMINALE</b> Rated Current	AMP	0.74	1.5	2.2	2.8	5.5							
<b>RESIST. ARMATURA</b> Armature resistance	Ohm	16.7	4.1	1.8	1.28	0.4							
<b>INDUTT. ARMATURA</b> Armature inductance	mH	46.5	10.25	4.15	2.95	0.8							
<b>COST. TENSIONE</b> Voltage constant	Ke V/Krpm	54	27	17	15	7							
<b>COST. TEMPO ELETT.</b> Elect. time constant	Te ms	2.8	2.5	2.3	2.3	2							
<b>COST. TEMPO MECC.</b> Mech. time constant	Tm ms	11	11	12	11	16							
<b>COST. TEMPO TERMICO</b> Thermal time constant	Tt min	20	20	20	20	20							

\* Solo su richiesta only by request (2) Altre tensioni a richiesta-other voltages by request (A) Coppia massima riduttore continuativa (A) Max. gear continuous torque (B) Massima coppia impulsiva riduttore (B) Max. gear pulse torque

### DATI MECCANICI - Mechanical data

<b>CARICO RADIALE</b> Radial Load	N	120
<b>CARICO ASSIALE</b> Axial Load	N	80
<b>PESO MOTORIDUTTORE</b> Gearmotor weight	Kg	3.6
<b>LUBRIFICAZIONE</b> Lubrication	<b>GRASSO</b> Long life grease	
<b>CORONA</b> Worm	<b>BRONZO</b> Bronze	
<b>VITE</b> Screw	<b>ACCIAIO</b> Steel	

### DATI ELETTRICI - Winding data

<b>CLASSE ISOLAMENTO</b> Insulation class	F	
<b>FATTORE DI SERVIZIO</b> Duty cycle	S1	
<b>FATTORE DI FORMA</b> Form Factor	FF	1
<b>TEMPERATURA AMBIENTE</b> Room temperature	T rif °C	40°
<b>GRADO DI PROTEZIONE</b> Protection	IP	54
<b>INERZIA ROTORE</b> Rotor inertia	Jm Kgcm <sup>2</sup>	0.00018

# ROK315X

DIMENSIONI (mm)

DIMENSIONS (mm)



**P \***

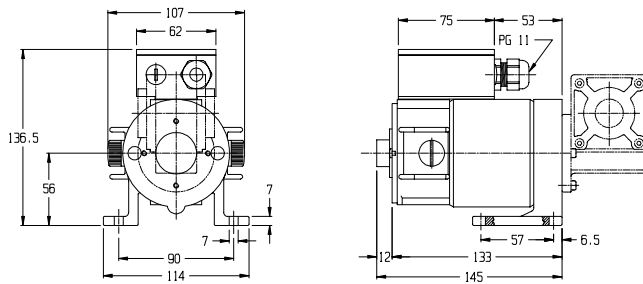

Vista frontale

Front view

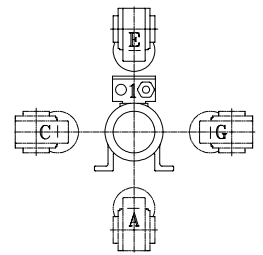

Configurazione

Configuration

**B \*\***

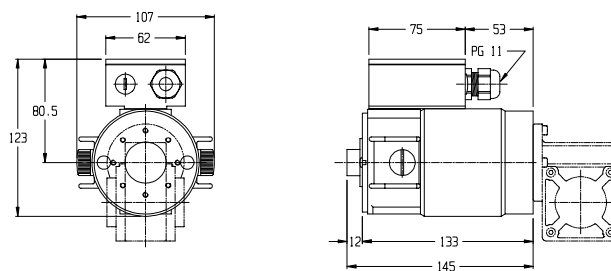

Vista frontale

Front view

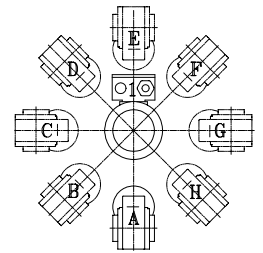

Configurazione

Configuration

**\* B.B10**

STD Config. **E1**

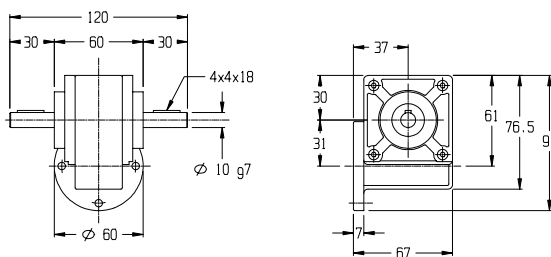

**\* B.K14**

STD Config. **E1**

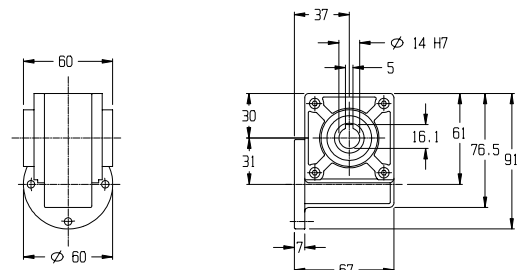

**\*\* P.B10**

STD Config. **A1**

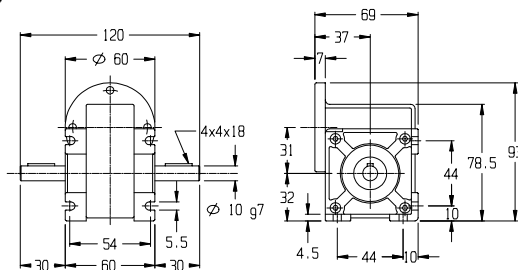

**\*\* P.K14**

STD Config. **A1**

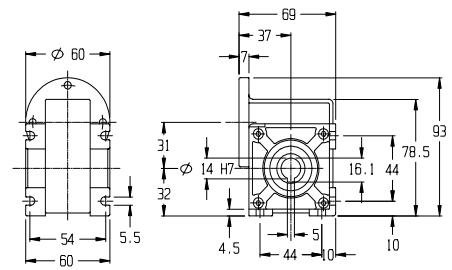

**\*\* FT1.S12.DX**

STD Config. **A1**

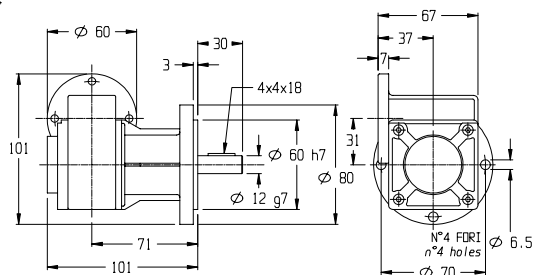

**\*\* P1.K14**

STD Config. **A1**

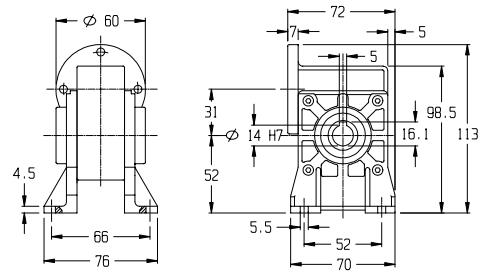

Accoppiare motore e riduttore contrassegnati dallo stesso segno \* / \*\*

Fitting motor and gear box marked with the same symbol \* / \*\*

SERIE-Series

# ROK 315XS

<b>WATT</b> Motore-motor <b>150</b>	<b>Nm</b> Riduttore-gear <b>10</b>
---	--

## CARATTERISTICHE GENERALI - Performance characteristics

MOTORE Motor		POTENZA - Power 150 W					VELOCITA - Speed 3000 RPM				COPPIA - Torque 0.48 Nm		
<b>RAPPORTO RIDUZIONE</b> Ratio	I:	<b>7</b>	<b>10</b>	<b>12</b>	<b>15</b>	<b>18</b>	<b>24</b>	<b>30</b>	<b>38</b>	<b>55</b>	<b>75</b>	<b>100*</b>	
<b>VELOCITA USCITA</b> Output speed	RPM	429	300	250	200	167	125	100	79	55	40	30*	
<b>COPPIA NOMINALE</b> Rated Torque	Nm	2.5	3.3	4	4.9	5.7	5.5	6.8	8.4	10.4	7.3	7.4	
<b>COPPIA MASSIMA</b> Max. Torque	Nm-max.	(A) (B)	9.7 14.5	9.5 14.2	12.1 18	10.7 16	10.3 15.5	9.2 13.8	10.3 15.4	11.4 17.1	10.4 15.6	7.3 12	7.4 12
<b>TENSIONE NOMINALE</b> Rated Voltage	VOLT	180	90	60	48	24	(2)						
<b>CORRENTE NOMINALE</b> Rated Current	AMP	1.1	2.27	3.3	4.2	8.33							
<b>RESIST. ARMATURA</b> Armature resistance	Ohm	13.9	3.5	1.64	1.1	0.29							
<b>INDUTT. ARMATURA</b> Armature inductance	mH	47	10.9	5.4	3.5	0.73							
<b>COST. TENSIONE</b> Voltage constant	Ke V/Krpm	54	26	18	15	7							
<b>COST. TEMPO ELETT.</b> Elect. time constant	Te ms	3.4	3.2	3.29	3.2	2.5							
<b>COST. TEMPO MECC.</b> Mech. time constant	Tm ms	15	17	17	16	19							
<b>COST. TEMPO TERMICO</b> Thermal time constant	Tt min	20	20	20	20	20							

\* Solo su richiesta only by request (2) Altre tensioni a richiesta-other voltages by request (A) Coppia massima riduttore continuativa (A) Max. gear continuous torque (B) Massima coppia impulsiva riduttore (B) Max. gear pulse torque

### DATI MECCANICI - Mechanical data

<b>CARICO RADIALE</b> Radial Load	N	120
<b>CARICO ASSIALE</b> Axial Load	N	80
<b>PESO MOTORIDUTTORE</b> Gearmotor weight	Kg	4.2
<b>LUBRIFICAZIONE</b> Lubrication	<b>GRASSO</b> Long life grease	
<b>CORONA</b> Worm	<b>BRONZO</b> Bronze	
<b>VITE</b> Screw	<b>ACCIAIO</b> Steel	

### DATI ELETTRICI - Winding data

<b>CLASSE ISOLAMENTO</b> Insulation class		F
<b>FATTORE DI SERVIZIO</b> Duty cycle		S1
<b>FATTORE DI FORMA</b> Form Factor	FF	1
<b>TEMPERATURA AMBIENTE</b> Room temperature	T rif °C	40°
<b>GRADO DI PROTEZIONE</b> Protection	IP	54
<b>INERZIA ROTORE</b> Rotor inertia	Jm Kgcm <sup>2</sup>	0.0003

# ROK315Xs

DIMENSIONI (mm)

DIMENSIONS (mm)



**P \***

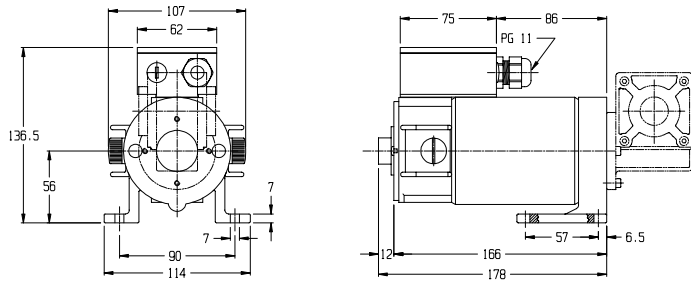

Vista frontale

Front view

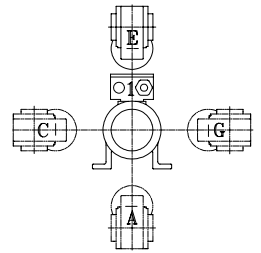

Configurazione

Configuration

**B \*\***

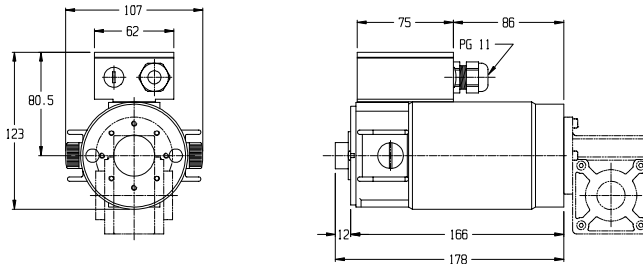

Vista frontale

Front view

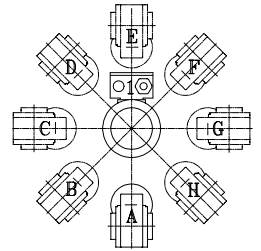

Configurazione

Configuration

**\* B.B10**

STD Config. **E1**

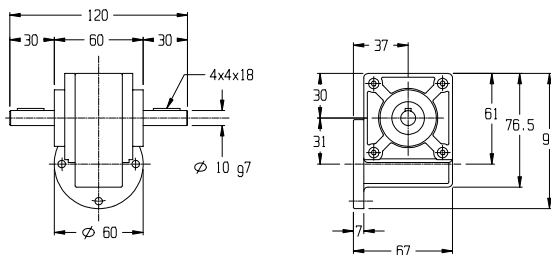

**\* B.K14**

STD Config. **E1**

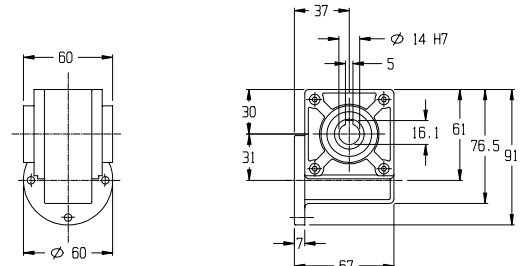

**\*\* P.B10**

STD Config. **A1**

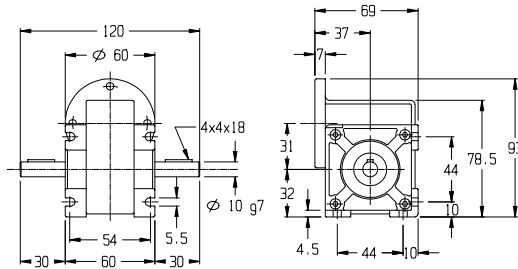

**\*\* P.K14**

STD Config. **A1**

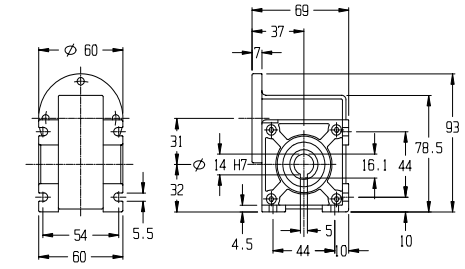

**\*\* FT1.S12.DX**

STD Config. **A1**

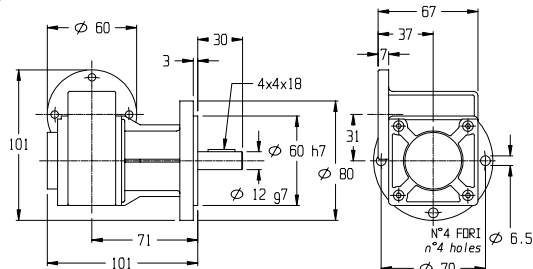

**\*\* P1.K14**

STD Config. **A1**

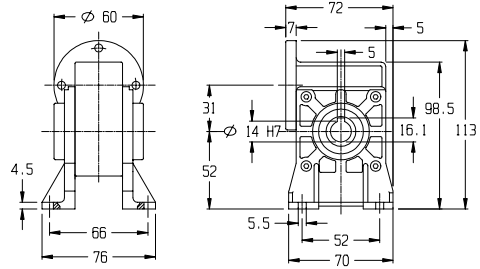

Accoppiare motore e riduttore contrassegnati dallo stesso segno \* / \*\*

Fitting motor and gear box marked with the same symbol \* / \*\*



SERIE-Series

# ROK 315S

<b>WATT</b> Motore-motor <b>200</b>	<b>Nm</b> Riduttore-gear <b>10</b>
---	--

## CARATTERISTICHE GENERALI - Performance characteristics

MOTORE Motor		POTENZA - Power 200 W					VELOCITA' - Speed 3000 RPM				COPPIA - Torque 0.64 Nm		
<b>RAPPORTO RIDUZIONE</b> Ratio	I:	7	10	12	15	18	24	30	38	55	75	100*	
<b>VELOCITA' USCITA</b> Output speed	RPM	429	300	250	200	167	125	100	79	55	40	30*	
<b>COPPIA NOMINALE</b> Rated Torque	Nm	3.4	4.4	5.3	6.5	7.6	7.4	9	11.2	10.4	7.3	7.4	
<b>COPPIA MASSIMA</b> Max. Torque	Nm-max.	(A) (B)	9.7 14.5	9.5 14.2	12.1 18	10.7 16	10.3 15.5	9.2 13.8	10.3 15.4	11.4 17.1	10.4 15.6	7.3 12	7.4 12
<b>TENSIONE NOMINALE</b> Rated Voltage	VOLT	180	87	60	48	24	(2)						
<b>CORRENTE NOMINALE</b> Rated Current	AMP	1.4	2.95	4.3	5.3	10.7							
<b>RESIST. ARMATURA</b> Armature resistance	Ohm	6.15	1.36	0.92	0.6	0.17							
<b>INDUTT. ARMATURA</b> Armature inductance	mH	20	3.9	2.5	1.5	0.32							
<b>COST. TENSIONE</b> Voltage constant	Ke V/Krpm	54	26	18	15	7							
<b>COST. TEMPO ELETT.</b> Elect. time constant	Te ms	3.3	2.9	2.7	2.5	1.9							
<b>COST. TEMPO MECC.</b> Mech. time constant	Tm ms	14	13	19	17	23							
<b>COST. TEMPO TERMICO</b> Thermal time constant	Tt min	30	30	30	30	30							

\* Solo su richiesta only by request (2) Altre tensioni a richiesta-other voltages by request (A) Coppia massima riduttore continuativa (A) Max. gear continuous torque (B) Massima coppia impulsiva riduttore (B) Max. gear pulse torque

### DATI MECCANICI - Mechanical data

<b>CARICO RADIALE</b> Radial Load	N	120
<b>CARICO ASSIALE</b> Axial Load	N	80
<b>PESO MOTORIDUTTORE</b> Gearmotor weight	Kg	5.3
<b>LUBRIFICAZIONE</b> Lubrication	<b>GRASSO</b> Long life grease	
<b>CORONA</b> Worm	<b>BRONZO</b> Bronze	
<b>VITE</b> Screw	<b>ACCIAIO</b> Steel	

### DATI ELETTRICI - Winding data

<b>CLASSE ISOLAMENTO</b> Insulation class		F
<b>FATTORE DI SERVIZIO</b> Duty cycle		S1
<b>FATTORE DI FORMA</b> Form Factor	FF	1
<b>TEMPERATURA AMBIENTE</b> Room temperature	T rif °C	40°
<b>GRADO DI PROTEZIONE</b> Protection	IP	54
<b>INERZIA ROTORE</b> Rotor inertia	Jm Kgcm <sup>2</sup>	0.0006

# ROK315S

DIMENSIONI (mm)

DIMENSIONS (mm)



**P \***

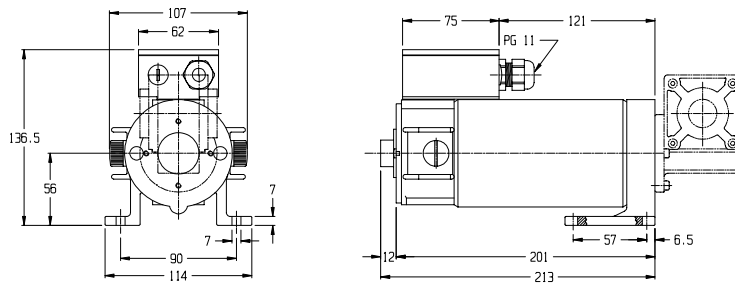

Vista frontale

Front view

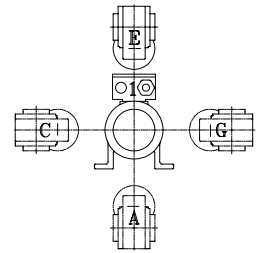

Configurazione

Configuration

**B \*\***

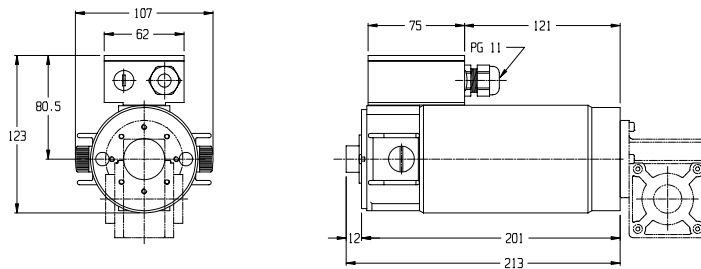

Vista frontale

Front view

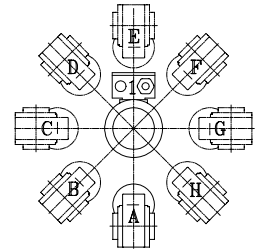

Configurazione

Configuration

**\* B.B10**

STD Config. **E1**

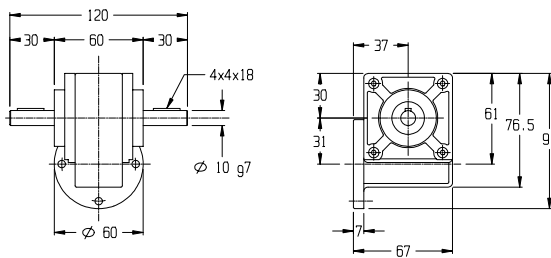

**\* B.K14**

STD Config. **E1**

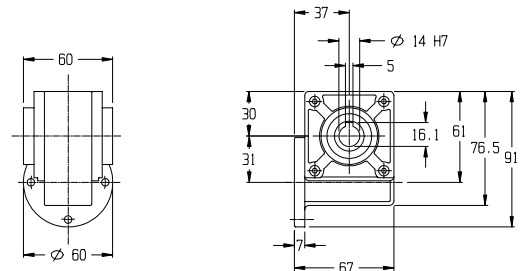

**\*\* P.B10**

STD Config. **A1**

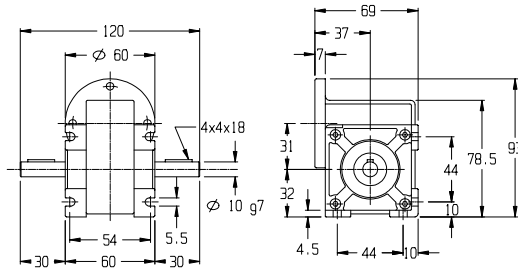

**\*\* P.K14**

STD Config. **A1**

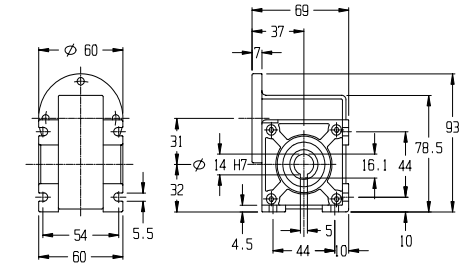

**\*\* FT1.S12.DX**

STD Config. **A1**

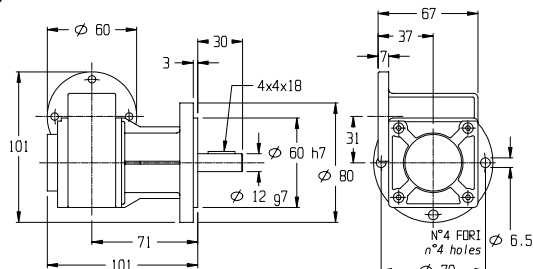

**\*\* P1.K14**

STD Config. **A1**

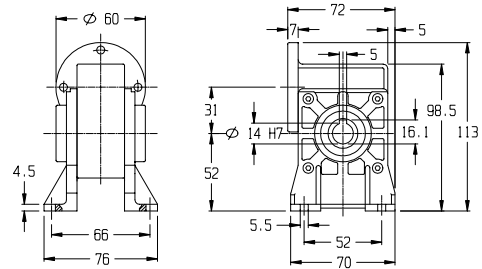

Accoppiare motore e riduttore contrassegnati dallo stesso segno \* / \*\*

Fitting motor and gear box marked with the same symbol \* / \*\*

# ROK315

OPTIONALS (mm)

## DINAMO TACHIMETRICA 01 TACHO GENERATOR

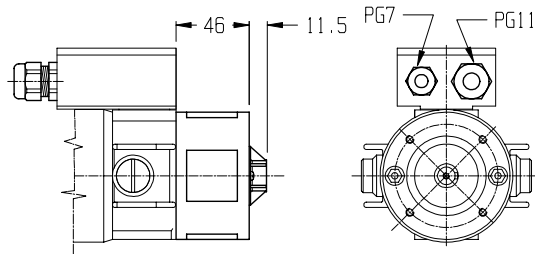

● PREDISPOSTO ENCODER ENCODER PREARRANGEMENT

COSTANTE DI TENSIONE VOLTAGE CONSTANT	10±5% V/KRPM	CORRENTE NOMINALE RATED CURRENT	2 mA
VELOCITA' MASSIMA MAX SPEED	9000 RPM	CORRENTE MASSIMA MAX CURRENT	8 mA

## CAVO 04 FLYNG LEADS

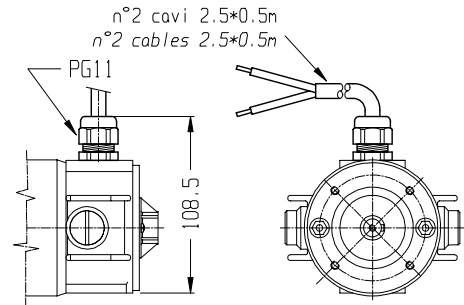

## CAVO + DINAMO TACHIMETRICA 05 TACHO GENERATOR + FLYNG LEADS

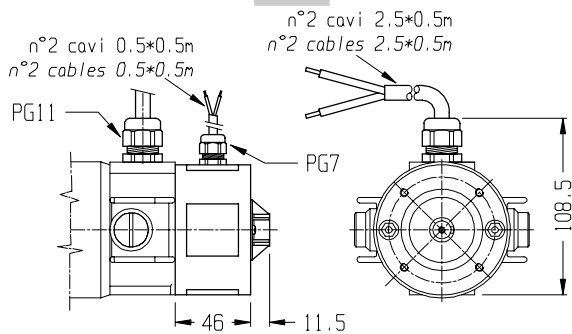

● PREDISPOSTO ENCODER ENCODER PREARRANGEMENT

COSTANTE DI TENSIONE VOLTAGE CONSTANT	10±5% V/KRPM	CORRENTE NOMINALE RATED CURRENT	2 mA
VELOCITA' MASSIMA MAX SPEED	9000 RPM	CORRENTE MASSIMA MAX CURRENT	8 mA

## PREDISPOSIZIONE ENCODER ● ENCODER PREARRANGEMENT

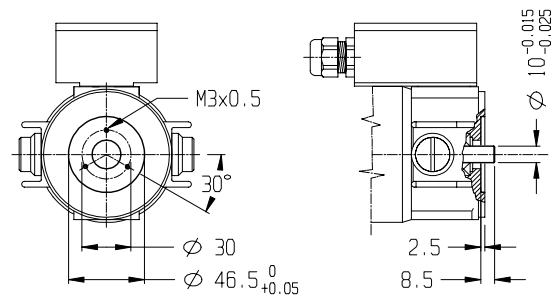

## ENCODER EH38 08 ENCODER EH38

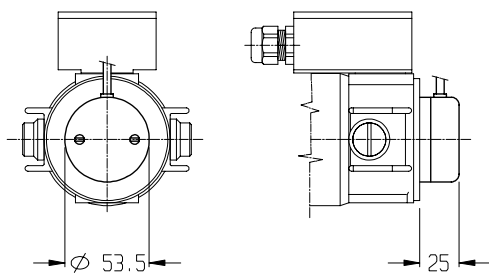

## ENCODER EH53 09 ENCODER EH53

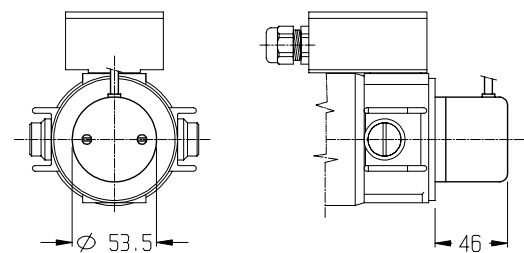

# ROK315

## OPTIONALS (mm)

**DISTANZIALE  
ENCODER N°1**

**10**

**ENCODER  
SPACER N°1**

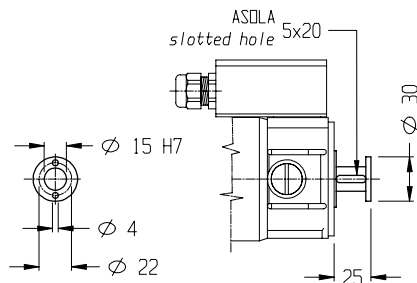

**DISTANZIALE  
ENCODER N°2**

**11**

**ENCODER  
SPACER N°2**

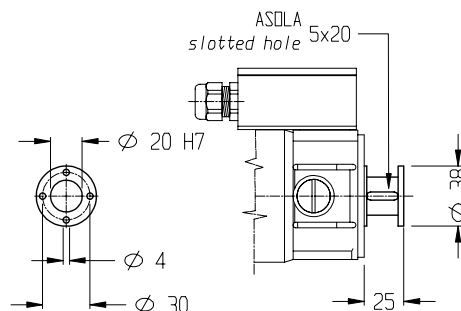

**FRENO 1.7 Nm**

**15**

**BRAKE 1.7 Nm**

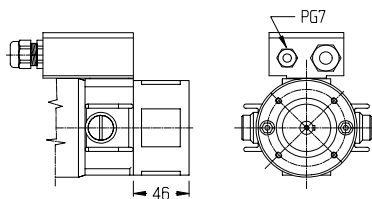

**FRENO 1.7 Nm +  
DIN. TACHIM.**

**16**

**TACHO GENERATOR  
+ BRAKE 1.7 Nm**

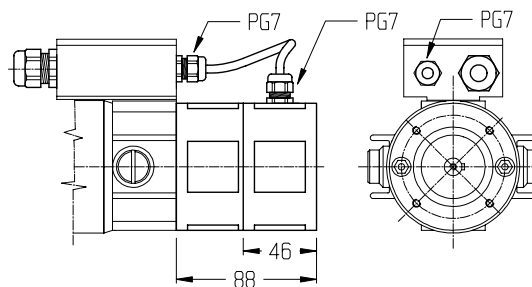

FRENO	BRAKE	DINAMO T.	TACHO G.
<b>COPPIA STATICA</b> STATIC TORQUE	1.7 Nm	<b>COSTANTE DI TENSIONE</b> VOLTAGE CONSTANT	10±5% V/KRPM
<b>TENSIONE DI ALIMEN.</b> POWER SUPPLY VOLTAGE	24-190 V.c.c.	<b>VELOCITA' MASSIMA</b> MAX SPEED	9000 RPM
<b>CORRENTE</b> CURRENT	0.46-0.058 A	<b>CORRENTE NOMINALE</b> RATED CURRENT	2 mA
<b>POTENZA ASSORBITA</b> INPUT POWER	11 W	<b>CORRENTE MASSIMA</b> MAX CURRENT	8 mA

<b>COPPIA STATICA</b> STATIC TORQUE	1.7 Nm	<b>CORRENTE</b> CURRENT	0.46-0.058 A
<b>TENSIONE DI ALIMEN.</b> POWER SUPPLY VOLTAGE	24-190 V.c.c.	<b>POTENZA ASSORBITA</b> INPUT POWER	11 W

# ROK 335

**TABELLA DI DEFINIZIONE SIGLA DI ORDINE PER MOTORIDUTTORI SERIE ROK 335**  
**HOW TO ORDER A ROK 335 WORMGEARMOTOR**

ROK	335S	30	48	01.04....	B	P.B10	07	A1
SERIE SERIES	TIPO TYPE	VELOCITA' MOTORE MOTOR SPEED	TENSIONE MOTORE MOTOR VOLTAGE	OPZIONI OPTIONS	VERSIONE MOTORE MOTOR VERSION	TIPO DI RIDUTTORE WORMGEAR TYPE	RAPPORTO DI RIDUZIONE RATIO	CONFIGU- RAZIONE CONFIGU- RATION
ROK	335XS 335S 335SL	30	24 48 60 90 180	<b>01-</b> Dinamo tachimetrica <i>Tacho generator</i> <b>04-</b> Uscita cavi 2P 0.5m <i>Flying leads 2P 0.5m</i> <b>05-</b> Uscita cavi 2P 0.5m + D.T. <i>Tacho g. + flying leads 2P 0.5m</i> <b>06-</b> Past. Termica (solo morset.) <i>Thermal cut-out (only on terminal box version)</i> <b>07-</b> Protezione IP55 <i>IP55</i> <b>08-</b> Pred. encoder EH38 <i>EH38 encoder prearrangement</i> <b>09-</b> Pred. encoder EH53 <i>EH53 encoder prearrangement</i> <b>10-</b> Distanziale encoder n°1 <i>Encoder spacer n°1</i> <b>11-</b> Distanziale encoder n°2 <i>Encoder spacer n°2</i> <b>15-</b> Freno 1.7 Nm <i>Brake 1.7 Nm</i> <b>16-</b> Freno 1.7 Nm + din. tachimet. <i>Tacho gen. + brake 1.7 Nm</i>	<b>B</b> : Base <i>Basic</i>  <b>P</b> : Piedi <i>Foot mounting</i>	B.B12 B.K14 P.B12 P.K14 FT3.S14.DX P1.K14	07 11 15 20 24 30 38 56 75	A1 B1 C1 D1 E1 F1 G1 H1

SERIE-Series

# ROK 335XS

<b>WATT</b> Motore-motor <b>150</b>	<b>Nm</b> Riduttore-gear <b>13</b>
---	--

## CARATTERISTICHE GENERALI - Performance characteristics

MOTORE <i>Motor</i>		POTENZA - Power 150 W					VELOCITA - Speed 3000 RPM					COPPIA - Torque 0.64 Nm		
<b>RAPPORTO RIDUZIONE</b> <i>Ratio</i>	I:	7	11	15	20	24	30	38	56	75				
<b>VELOCITA USCITA</b> <i>Output speed</i>	RPM	429	273	200	150	125	100	79	54	40				
<b>COPPIA NOMINALE</b> <i>Rated Torque</i>	Nm	2.4	3.4	4.3	5.2	5.6	6.2	7.5	7.8	8.6				
<b>COPPIA MASSIMA</b> <i>Max. Torque</i>	Nm-max.	(A) (B)	12 18	13 20	13 19.5	13 19	13 20	13 19	14 20	10 15	9 13.5			
<b>TENSIONE NOMINALE</b> <i>Rated Voltage</i>	VOLT	180	90	60	48	24	(2)							
<b>CORRENTE NOMINALE</b> <i>Rated Current</i>	AMP	1.1	2.27	3.3	4.2	8.33								
<b>RESIST. ARMATURA</b> <i>Armature resistance</i>	Ohm	13.9	3.5	1.64	1.1	0.29								
<b>INDUTT. ARMATURA</b> <i>Armature inductance</i>	mH	47	10.9	5.4	3.5	0.73								
<b>COST. TENSIONE</b> <i>Voltage constant</i>	Ke V/Krpm	54	26	18	15	7								
<b>COST. TEMPO ELETT.</b> <i>Elect. time constant</i>	Te ms	3.4	3.2	3.29	3.2	2.5								
<b>COST. TEMPO MECC.</b> <i>Mech. time constant</i>	Tm ms	15	17	17	16	19								
<b>COST. TEMPO TERMICO</b> <i>Thermal time constant</i>	Tt min	15	15	15	15	15								

(2) Altre tensioni a richiesta - other voltages by request (A) Coppia massima riduttore continuativa (A) Max. gear continuous torque  
(B) Massima coppia impulsiva riduttore (B) Max. gear pulse torque

### DATI MECCANICI - Mechanical data

<b>CARICO RADIALE</b> <i>Radial Load</i>	N	140
<b>CARICO ASSIALE</b> <i>Axial Load</i>	N	100
<b>PESO MOTORIDUTTORE</b> <i>Gearmotor weight</i>	Kg	4.3
<b>LUBRIFICAZIONE</b> <i>Lubrication</i>	<b>GRASSO</b> Long life grease	
<b>CORONA</b> <i>Worm</i>	<b>BRONZO</b> Bronze	
<b>VITE</b> <i>Screw</i>	<b>ACCIAIO</b> Steel	

### DATI ELETTRICI - Winding data

<b>CLASSE ISOLAMENTO</b> <i>Insulation class</i>		F
<b>FATTORE DI SERVIZIO</b> <i>Duty cycle</i>		S1
<b>FATTORE DI FORMA</b> <i>Form Factor</i>	FF	1
<b>TEMPERATURA AMBIENTE</b> <i>Room temperature</i>	T rif °C	40°
<b>GRADO DI PROTEZIONE</b> <i>Protection</i>	IP	54
<b>INERZIA ROTORE</b> <i>Rotor inertia</i>	Jm Kgc <sup>m2</sup>	0.0003

# ROK335X

DIMENSIONI (mm)

DIMENSIONS (mm)



**P \***

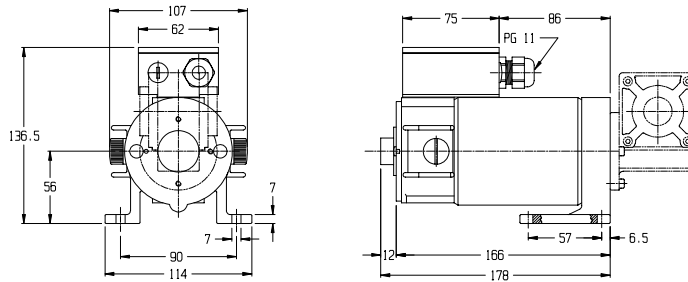

Vista frontale

Front view

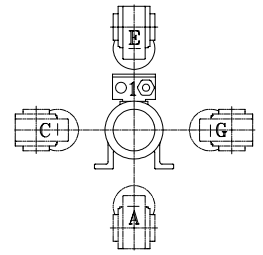

Configurazione

Configuration

**B \*\***

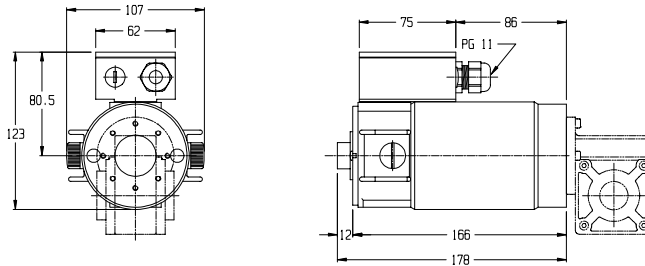

Vista frontale

Front view

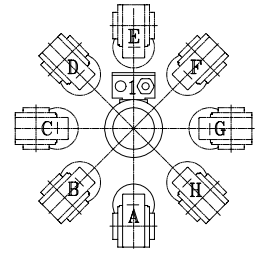

Configurazione

Configuration

**\* B.B12**

STD Config. **E1**

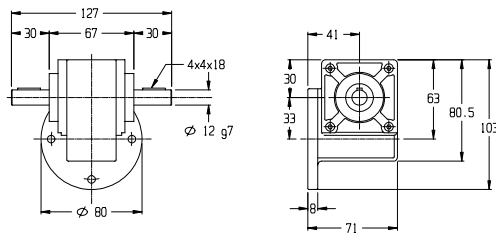

**\* B.K14**

STD Config. **E1**

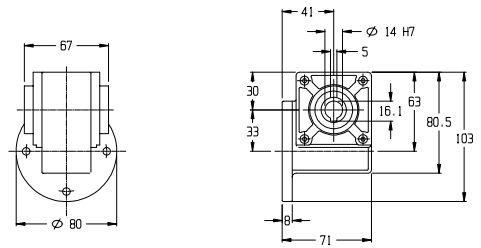

**\*\* P.B12**

STD Config. **A1**

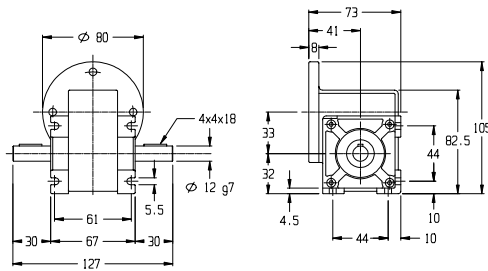

**\*\* P.K14**

STD Config. **A1**

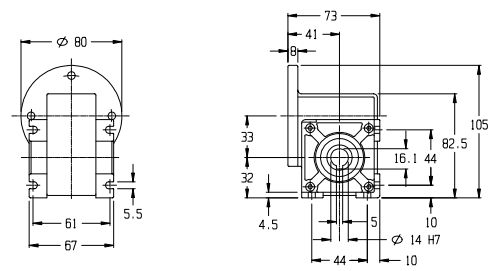

**\*\* FT3.S14.DX**

STD Config. **A1**

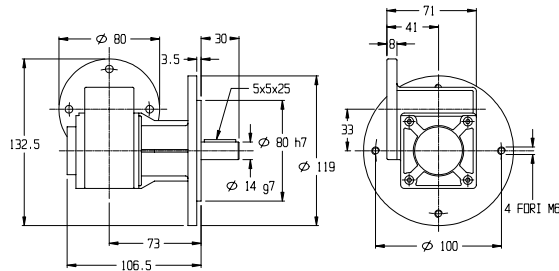

**\*\* P1.K14**

STD Config. **A1**

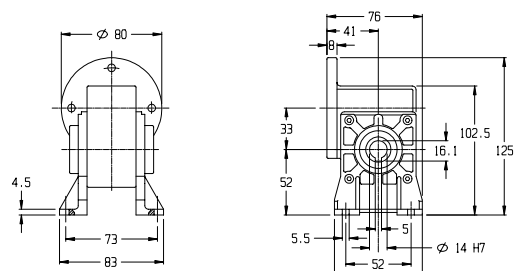

Accoppiare motore e riduttore contrassegnati dallo stesso segno \* / \*\*

Fitting motor and gear box marked with the same symbol \* / \*\*

SERIE-Series

# ROK 335S

<b>WATT</b> Motore-motor <b>200</b>	<b>Nm</b> Riduttore-gear <b>13</b>
---	--

## CARATTERISTICHE GENERALI - Performance characteristics

MOTORE Motor		POTENZA - Power 200 W					VELOCITA - Speed 3000 RPM					COPPIA - Torque 0.64 Nm		
<b>RAPPORTO RIDUZIONE</b> Ratio	I:	<b>7</b>	<b>11</b>	<b>15</b>	<b>20</b>	<b>24</b>	<b>30</b>	<b>38</b>	<b>56</b>	<b>75</b>				
<b>VELOCITA USCITA</b> Output speed	RPM	429	273	200	150	125	100	79	54	40				
<b>COPPIA NOMINALE</b> Rated Torque	Nm	3.2	4.6	5.8	6.9	7.5	8.3	10	10	9				
<b>COPPIA MASSIMA</b> Max. Torque	Nm-max.	(A) 12 (B) 18	13 20	13 19.5	13 19	13 20	13 19	14 20	10 15	9 13.5				
<b>TENSIONE NOMINALE</b> Rated Voltage	VOLT	180	90	60	48	24	(2)							
<b>CORRENTE NOMINALE</b> Rated Current	AMP	1.4	2.95	4.3	5.3	10.7								
<b>RESIST. ARMATURA</b> Armature resistance	Ohm	6.15	1.36	0.92	0.6	0.17								
<b>INDUTT. ARMATURA</b> Armature inductance	mH	20	3.9	2.5	1.5	0.32								
<b>COST. TENSIONE</b> Voltage constant	Ke V/Krpm	54	26	18	15	7								
<b>COST. TEMPO ELETT.</b> Elect. time constant	Te ms	3.3	2.9	2.7	2.5	1.9								
<b>COST. TEMPO MECC.</b> Mech. time constant	Tm ms	14	13	19	17	23								
<b>COST. TEMPO TERMICO</b> Thermal time constant	Tt min	30	30	30	30	30								

(2) Altre tensioni a richiesta-other voltages by request (A) Coppia massima riduttore continuativa (A) Max. gear continuous torque  
(B) Massima coppia impulsiva riduttore (B) Max. gear pulse torque

### DATI MECCANICI - Mechanical data

<b>CARICO RADIALE</b> Radial Load	N	140
<b>CARICO ASSIALE</b> Axial Load	N	100
<b>PESO MOTORIDUTTORE</b> Gearmotor weight	Kg	5.4
<b>LUBRIFICAZIONE</b> Lubrication	<b>GRASSO</b> Long life grease	
<b>CORONA</b> Worm	<b>BRONZO</b> Bronze	
<b>VITE</b> Screw	<b>ACCIAIO</b> Steel	

### DATI ELETTRICI - Winding data

<b>CLASSE ISOLAMENTO</b> Insulation class		F
<b>FATTORE DI SERVIZIO</b> Duty cycle		S1
<b>FATTORE DI FORMA</b> Form Factor	FF	1
<b>TEMPERATURA AMBIENTE</b> Room temperature	T rif °C	40°
<b>GRADO DI PROTEZIONE</b> Protection	IP	54
<b>INERZIA ROTORE</b> Rotor inertia	Jm Kgcm <sup>2</sup>	0.0006



# ROK335S

DIMENSIONI (mm)

DIMENSIONS (mm)



**P \***

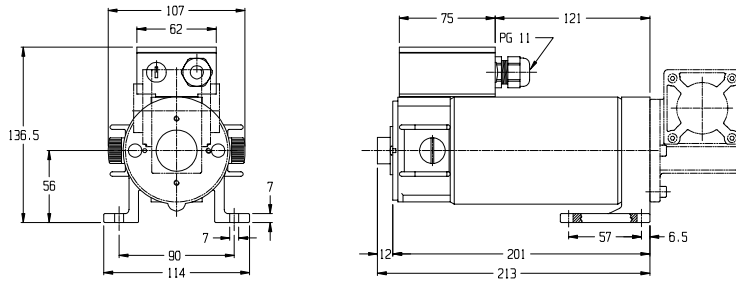

Vista frontale

Front view

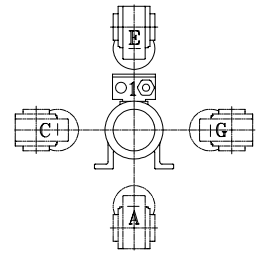

Configurazione

Configuration

**B \*\***

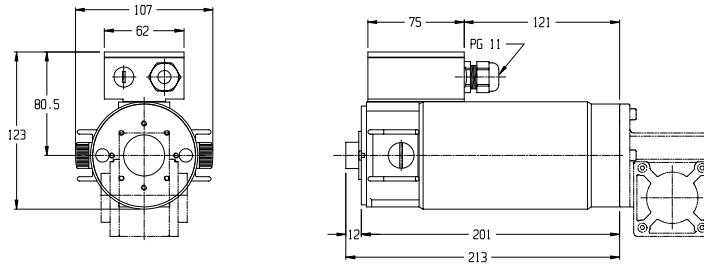

Vista frontale

Front view

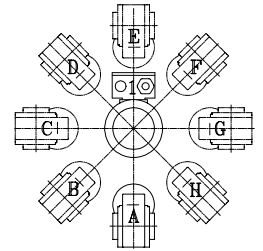

Configurazione

Configuration

**\* B.B12**

STD Config. **E1**

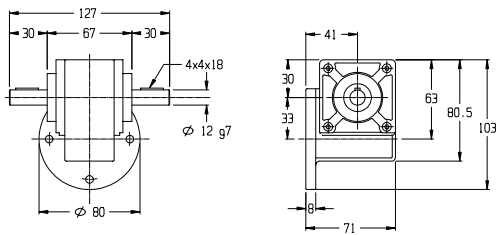

**\* B.K14**

STD Config. **E1**

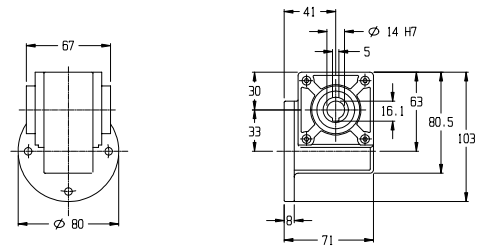

**\*\* P.B12**

STD Config. **A1**

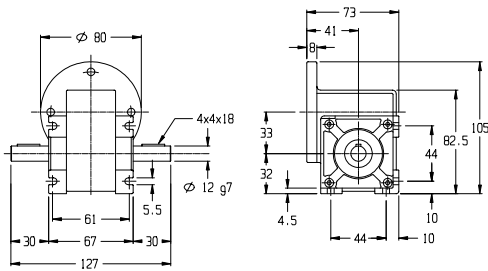

**\*\* P.K14**

STD Config. **A1**

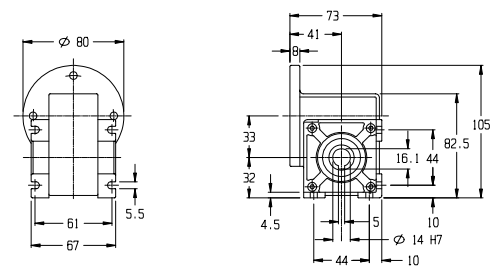

**\*\* FT3.S14.DX**

STD Config. **A1**

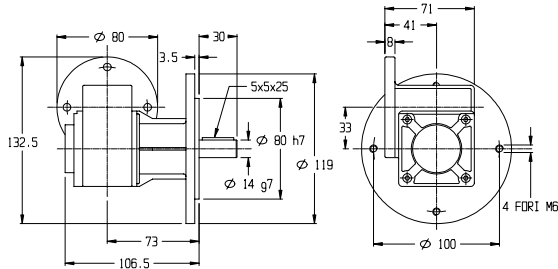

**\*\* P1.K14**

STD Config. **A1**

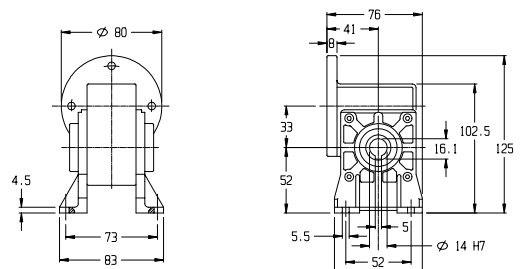

Accoppiare motore e riduttore contrassegnati dallo stesso segno \* / \*\*

Fitting motor and gear box marked with the same symbol \* / \*\*

SERIE-Series

# ROK 335SL

**WATT**  
Motore-motor  
**300**

**Nm**  
Riduttore-gear  
**13**

## CARATTERISTICHE GENERALI - Performance characteristics

MOTORE Motor		POTENZA - Power 300 W					VELOCITA - Speed 3000 RPM					COPPIA - Torque 0.96 Nm			
<b>RAPPORTO RIDUZIONE</b> Ratio	I:	7	11	15	20	24	30	38	56	75					
<b>VELOCITA USCITA</b> Output speed	RPM	429	273	200	150	125	100	79	54	40					
<b>COPPIA NOMINALE</b> Rated Torque	Nm	4.8	6.9	8.6	10.4	11.3	12.4	14	10	9					
<b>COPPIA MASSIMA</b> Max. Torque	Nm-max.	(A) (B)	12 18	13 20	13 19.5	13 19	13 20	13 19	14 20	10 15	9 13.5				
<b>TENSIONE NOMINALE</b> Rated Voltage	VOLT	180	90	60	48	24	(2)								
<b>CORRENTE NOMINALE</b> Rated Current	AMP	2.1	4.2	6.3	7.8	15.6									
<b>RESIST. ARMATURA</b> Armature resistance	Ohm	5.3	1.41	0.67	0.4	0.16									
<b>INDUTT. ARMATURA</b> Armature inductance	mH	18	4.1	2	1.2	0.32									
<b>COST. TENSIONE</b> Voltage constant	Ke V/Krpm	55.5	27	19	15	7.5									
<b>COST. TEMPO ELETT.</b> Elect. time constant	Te ms	3.5	3.13	3	3	2									
<b>COST. TEMPO MECC.</b> Mech. time constant	Tm ms	13	19	14	14	22									
<b>COST. TEMPO TERMICO</b> Thermal time constant	Tt min	35	35	35	35	35									

(2) Altre tensioni a richiesta-other voltages by request (A) Coppia massima riduttore continuativa (A) Max. gear continuous torque  
(B) Massima coppia impulsiva riduttore (B) Max. gear pulse torque

### DATI MECCANICI - Mechanical data

<b>CARICO RADIALE</b> Radial Load	N	140
<b>CARICO ASSIALE</b> Axial Load	N	100
<b>PESO MOTORIDUTTORE</b> Gearmotor weight	Kg	6
<b>LUBRIFICAZIONE</b> Lubrication	<b>GRASSO</b> Long life grease	
<b>CORONA</b> Worm	<b>BRONZO</b> Bronze	
<b>VITE</b> Screw	<b>ACCIAIO</b> Steel	

### DATI ELETTRICI - Winding data

<b>CLASSE ISOLAMENTO</b> Insulation class		F
<b>FATTORE DI SERVIZIO</b> Duty cycle		S1
<b>FATTORE DI FORMA</b> Form Factor	FF	1
<b>TEMPERATURA AMBIENTE</b> Room temperature	T rif °C	40°
<b>GRADO DI PROTEZIONE</b> Protection	IP	54
<b>INERZIA ROTORE</b> Rotor inertia	Jm Kgcm <sup>2</sup>	0.0007

# ROK335SL

DIMENSIONI (mm)

DIMENSIONS (mm)



**P \***

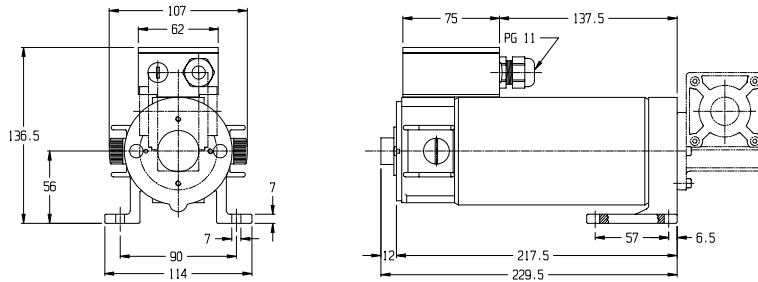

Vista frontale

Front view

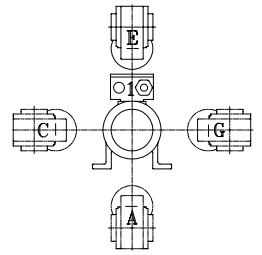

Configurazione

Configuration

**B \*\***

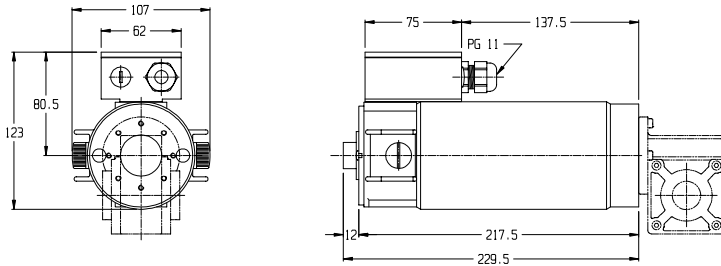

Vista frontale

Front view

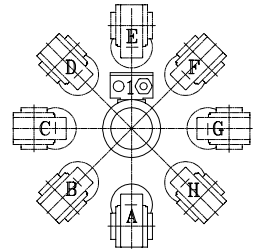

Configurazione

Configuration

**\* B.B12**

STD Config. **E1**

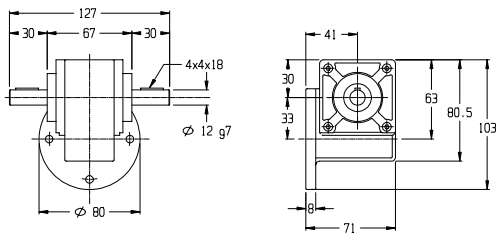

**\* B.K14**

STD Config. **E1**

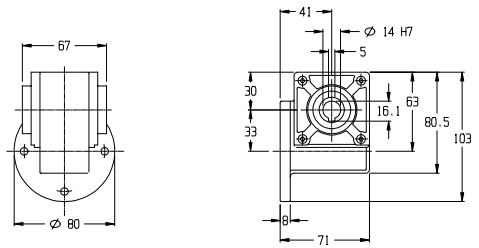

**\*\* P.B12**

STD Config. **A1**

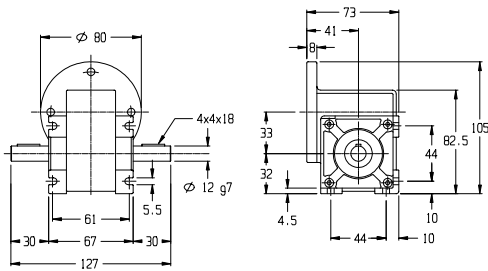

**\*\* P.K14**

STD Config. **A1**

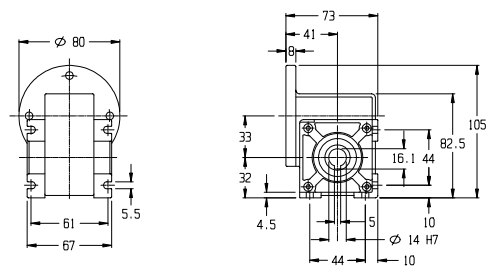

**\*\* FT3.S14.DX**

STD Config. **A1**

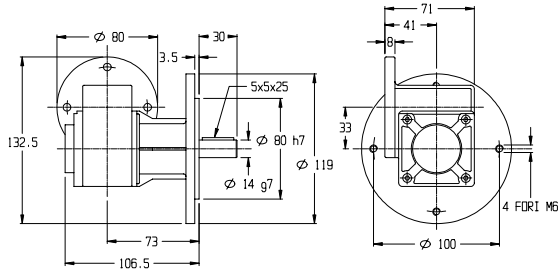

**\*\* P1.K14**

STD Config. **A1**

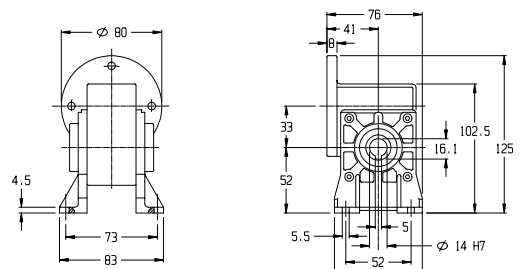

Accoppiare motore e riduttore contrassegnati dallo stesso segno \* / \*\*

Fitting motor and gear box marked with the same symbol \* / \*\*

# ROK335

OPTIONALS (mm)

## DINAMO TACHIMETRICA 01 TACHO GENERATOR

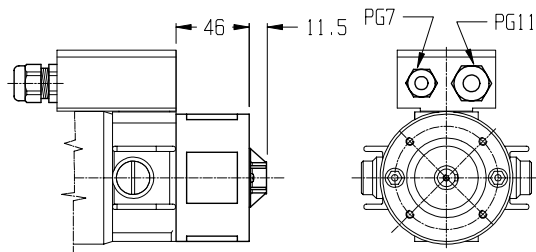

● PREDISPOSTO ENCODER ENCODER PREARRANGEMENT

COSTANTE DI TENSIONE VOLTAGE CONSTANT	10±5% V/KRPM	CORRENTE NOMINALE RATED CURRENT	2 mA
VELOCITA' MASSIMA MAX SPEED	9000 RPM	CORRENTE MASSIMA MAX CURRENT	8 mA

## CAVO 04 FLYNG LEADS

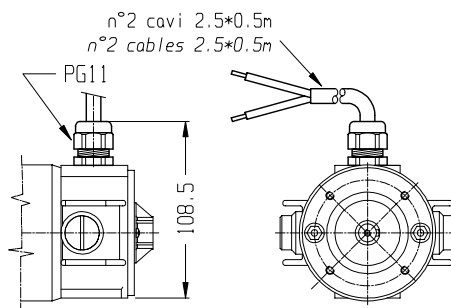

## CAVO + DINAMO TACHIMETRICA 05 TACHO GENERATOR + FLYNG LEADS

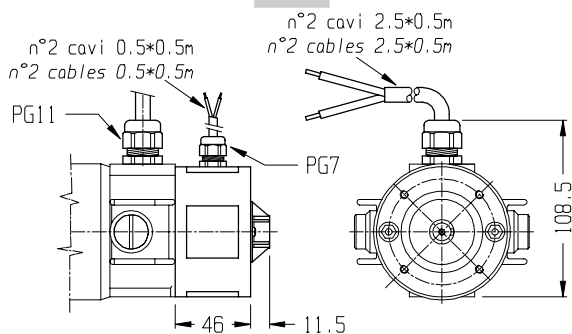

● PREDISPOSTO ENCODER ENCODER PREARRANGEMENT

COSTANTE DI TENSIONE VOLTAGE CONSTANT	10±5% V/KRPM	CORRENTE NOMINALE RATED CURRENT	2 mA
VELOCITA' MASSIMA MAX SPEED	9000 RPM	CORRENTE MASSIMA MAX CURRENT	8 mA

## PREDISPOSIZIONE ENCODER 06 ENCODER PREARRANGEMENT

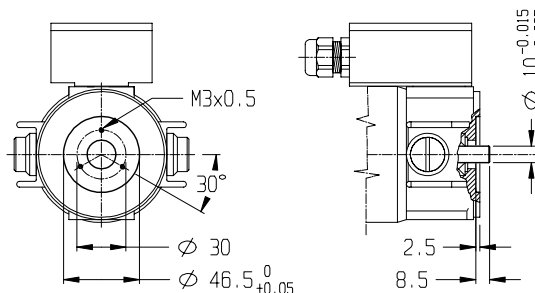

## ENCODER EH38 08 ENCODER EH38

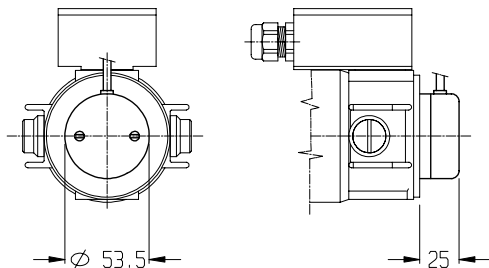

## ENCODER EH53 09 ENCODER EH53

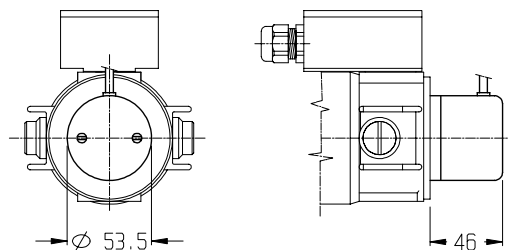

# ROK335

## OPTIONALS (mm)

**DISTANZIALE  
ENCODER N°1**

**10**

*ENCODER  
SPACER N°1*

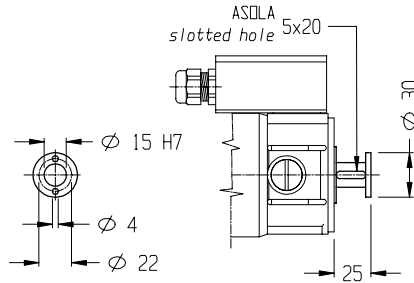

**DISTANZIALE  
ENCODER N°2**

**11**

*ENCODER  
SPACER N°2*

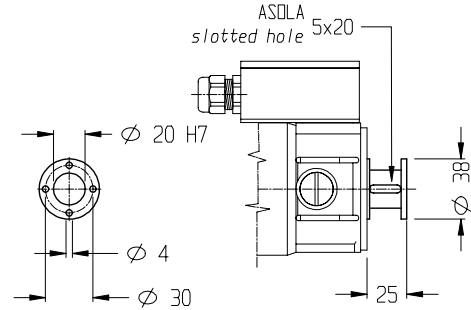

**FRENO 1.7 Nm**

**15**

*BRAKE 1.7 Nm*

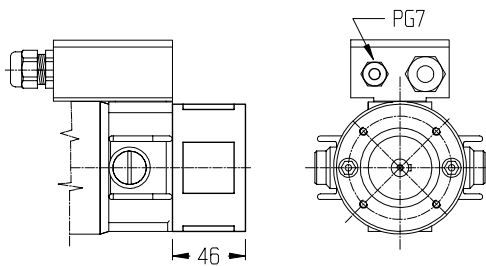

**FRENO 1.7 Nm +  
DIN. TACHIM.**

**16**

*TACHO GENERATOR  
+ BRAKE 1.7 Nm*

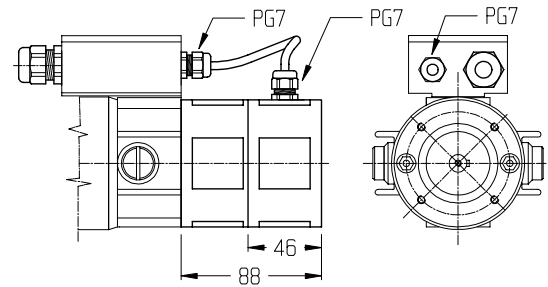

<b>COPPIA STATICA</b> STATIC TORQUE	1.7 Nm	<b>CORRENTE</b> CURRENT	0.46-0.058 A
<b>TENSIONE DI ALIMEN.</b> POWER SUPPLY VOLTAGE	24-190 V.c.c.	<b>POTENZA ASSORBITA</b> INPUT POWER	11 W

	FRENO BRAKE	DINAMO T. TACHO G.	
<b>COPPIA STATICA</b> STATIC TORQUE	1.7 Nm	<b>COSTANTE DI TENSIONE</b> VOLTAGE CONSTANT	10±5% V/KRPM
<b>TENSIONE DI ALIMEN.</b> POWER SUPPLY VOLTAGE	24-190 V.c.c.	<b>VELOCITA' MASSIMA</b> MAX SPEED	9000 RPM
<b>CORRENTE</b> CURRENT	0.46-0.058 A	<b>CORRENTE NOMINALE</b> RATED CURRENT	2 mA
<b>POTENZA ASSORBITA</b> INPUT POWER	11 W	<b>CORRENTE MASSIMA</b> MAX CURRENT	8 mA