

Installation Guide

DMR 50-5/50 V3.0

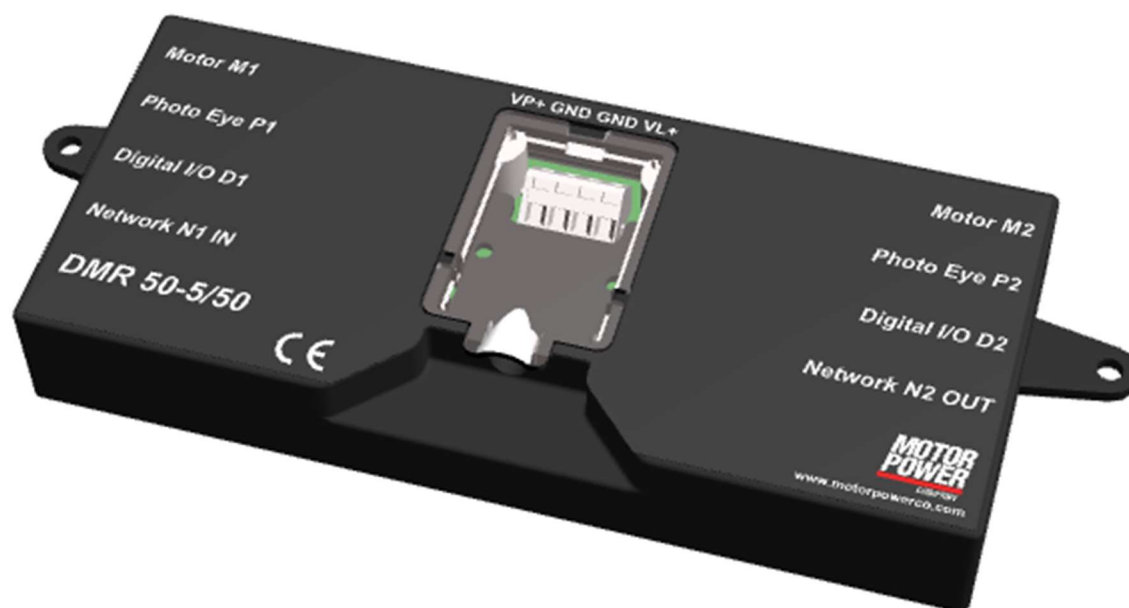

Motor Power Company s.r.l.

Via Leonardo Da Vinci, 4
42024 Castelnovo Sotto Reggio Emilia - Italia
Tel. +39 0522 682710 - Fax +39 0522 683552
info@motorpowerco.it - motorpowerco.com
Cap. Soc. 250.000,00€ i.v. - R.E.A. di RE 175521
Iscr.Reg.Impr. di RE n.01308390358 - N. Mecc. RE 010210
C.F. e P.IVA IT 01308390358

**MOTOR
POWER**
COMPANY

1 Index

2	Product Presentation	4
2.1	General Description	4
3	Safety Information	5
3.1	Warnings	6
3.2	Cautions	7
3.3	Directives and Standards	8
3.4	CE Mark Conformance.....	8
3.5	Warranty Information	8
3.6	Drawings	9
3.7	Typical Installation.....	9
3.8	Specifications	10
3.9	Environmental Conditions	10
3.10	Available Models.....	11
3.10.1	Type Plate	11
4	Location of Items	12
5	Wiring	13
5.1	Connector XP1 – Power Supply	13
5.2	Connector M1, M2 – Motor Connector	14
5.3	Connector P1, P2 - Photo Eye Connector	15
5.3.1	Photo Eye internal connection	15
5.4	Connector D1, D2 - Standard Function Connector.....	16
5.4.1	Digital Input internal wiring.....	17
5.4.2	Analog Input internal wiring	17
5.4.3	Digital Output Internal wiring	18
5.5	Connector N1,N2 - Network Connection.....	19
6	Connection schematic.....	20
6.1	Schematic circuit for power and logic supply	21
7	Default I/O Functionality	21
7.1	Run/Stop	21

Motor Power Company s.r.l.

Via Leonardo Da Vinci, 4
 42024 Castelnovo Sotto Reggio Emilia - Italia
 Tel. +39 0522 682710 - Fax +39 0522 683552
 info@motorpowerco.it - motorpowerco.com
 Cap. Soc. 250.000,00€ i.v. - R.E.A. di RE 175521
 Iscr.Reg.Impr. di RE n.01308390358 - N. Mecc. RE 010210
 C.F. e P.IVA IT 01308390358



7.2	DIR – Direction of Rotation.....	23
7.3	V-IN – Speed Variation.....	23
7.4	ERR – Error Signal	24
7.5	Customized I/O configuration	24
8	LED Configuration	25
8.1	LED Map.....	25
8.2	L1 and L2 Axis Status.....	26
8.3	L3 Auxiliary Power Supply Status	26
8.4	L5 Device Status.....	26
9	Information on the motor	27
9.1	Motor Phase Angle.....	27
9.2	Hall signal sequence	28
9.3	Motor Phase Sequence.....	29
10	Standard Configuration Interface.....	30
10.1	Setup for Modbus RTU.....	30
10.2	Standard communication parameters	32

Notice:

This guide delivered subject to the following conditions and restrictions: This guide contains proprietary information belonging to Motor power Company Srl. Such information is supplied solely for the purpose of assisting users of the DMR 50-5/50 servo drive in its installation and configuration.

The text and graphics included in this manual are for the purpose of illustration and reference only. The specifications on which they are based are subject to change without notice.

Motor power Company and the Motor power Company logo are trademarks of Motor power Company Srl.

Information in this document is subject to change without notice.

Version	Date	Author	Note
1.0	01/11/2018	Maurizio Piccinelli	Initial Release
2.0	15/06/2020	Maurizio Piccinelli	Few updates
3.0	18/08/2021	Piccinelli, Piacentini, Zivieri, Bassoli	LED, RS485 User Interface

Motor Power Company s.r.l.

Via Leonardo Da Vinci, 4
42024 Castelnovo Sotto Reggio Emilia - Italia
Tel. +39 0522 682710 - Fax +39 0522 683552
info@motorpowerco.it - motorpowerco.com
Cap. Soc. 250.000,00€ i.v. - R.E.A. di RE 175521
Iscr.Reg.Impr. di RE n.01308390358 - N. Mecc. RE 010210
C.F. e P.IVA IT 01308390358



2 Product Presentation

2.1 General Description

The DMR 50-5/50 is a Motoroller servo drive especially designed for Motor Power Company Gearless motoroller.



We have different available versions with different Digital I/O configuration (PNP,NPN)



The Device is able to operate one or 2 different devices independently, and is compatible with all the size 46 Gearless Motoroller.

3 Safety Information

In order to achieve the optimum, safe operation of the MDR servo drive, it is imperative that you implement the safety procedures included in this installation guide. This information is provided to protect you and to keep your work area safe when operating the MDR and accompanying equipment. Please read this chapter carefully before you begin the installation process. Before you start, ensure that all system components are connected to earth ground.

Electrical safety is provided through a low-resistance earth connection. Only qualified personnel may install, adjust, maintain and repair the servo drive. A "qualified person" has the knowledge and authorization to perform tasks such as transporting, assembling, installing, commissioning and operating motors.

The DMR servo drive contains electrostatic-sensitive components that can be damaged if handled incorrectly. To prevent any electrostatic damage, avoid contact with highly insulating materials, such as plastic film and synthetic fabrics. Place the product on a conductive surface and ground yourself in order to discharge any possible static electricity build-up. To avoid any potential hazards that may cause severe personal injury or damage to the product during operation, keep all covers and cabinet doors shut. The following safety symbols are used in this manual:





	<p>Warning: This information is needed to avoid a safety hazard, which might cause bodily injury.</p>
	<p>Caution: This information is necessary for preventing damage to the product or to other equipment.</p>
	<p>Note: This is auxiliary information that ensures the correct operation of the equipment.</p>

Motor Power Company s.r.l.

Via Leonardo Da Vinci, 4
42024 Castelnovo Sotto Reggio Emilia - Italia
Tel. +39 0522 682710 - Fax +39 0522 683552
info@motorpowerco.it - motorpowerco.com
Cap. Soc. 250.000,00€ i.v. - R.E.A. di RE 175521
Iscr.Reg.Impr. di RE n.01308390358 - N. Mecc. RE 010210
C.F. e P.IVA IT 01308390358



3.1 Warnings





	<p>To avoid electric hazards to personnel and electrical contacts, never connect/disconnect the servo drive while the power source is on.</p>
	<p>Power cables can carry a high voltage, even when the motor is not in motion. Disconnect the DMR 50-50/50 from all voltage sources before it is open for servicing.</p>
	<p>The DMR 50-50/50 servo drive contains grounding conduits for electric current protection. Any disruption to these conduits may cause the device to become "hot" (live) and dangerous.</p>
	<p>After shutting off the power and removing the power source from your equipment, wait at least 3 minute before touching or disconnecting parts of the equipment that are normally loaded with electrical charges (such as capacitors or contacts). Measuring the electrical contact points with a meter before touching the equipment is recommended.</p>

Motor Power Company s.r.l.

Via Leonardo Da Vinci, 4
 42024 Castelnovo Sotto Reggio Emilia - Italia
 Tel. +39 0522 682710 - Fax +39 0522 683552
 info@motorpowerco.it - motorpowerco.com
 Cap. Soc. 250.000,00€ i.v. - R.E.A. di RE 175521
 Iscr.Reg.Impr. di RE n.01308390358 - N. Mecc. RE 010210
 C.F. e P.IVA IT 01308390358

**MOTOR
 POWER**
 COMPANY

3.2 Cautions

	<p>The DMR 50-50/50 servo drive contains hot surfaces and electrically-charged components during operation.</p>
	<p>The maximum DC power supply connected to the instrument must comply with the parameters outlined in this guide.</p>
	<p>The DMR 50-50/50 servo drive must be connected to an approved 24VDC auxiliary power supply through a line that is separated from hazardous line voltages using reinforced or double insulation in accordance with approved safety standards.</p>
	<p>The DMR 50-50/50 series is designed to get its power from a 48 VDC power source. Power to this device must be supplied by DC voltage, within the boundaries specified for the DMR. High voltages may damage the drive. The DC power supply voltage range is defined in this manual. Safety margins must be considered in order to avoid activating the under or over-voltage protection against line variations and/or voltage drop under load. The transformer should be able to deliver the required power to the drive (including peak power) without significant voltage drops (10% maximum). While driving high-inertia loads, the power supply circuit must be equipped with a shunt regulator; otherwise, the drive will be disabled whenever the capacitors are charged above the maximum voltage</p>
	<p>Before switching on the DMR, verify that all safety precautions have been observed and that the installation procedures in this manual have been followed.</p>

Motor Power Company s.r.l.

Via Leonardo Da Vinci, 4
 42024 Castelnovo Sotto Reggio Emilia - Italia
 Tel. +39 0522 682710 - Fax +39 0522 683552
 info@motorpowerco.it - motorpowerco.com
 Cap. Soc. 250.000,00€ i.v. - R.E.A. di RE 175521
 Iscr.Reg.Impr. di RE n.01308390358 - N. Mecc. RE 010210
 C.F. e P.IVA IT 01308390358



3.3 Directives and Standards

The DMR 50-5/50 servo drive conforms to the following industry safety standards:

Safety Standard	Item
Designed in Compliance with UL508c and UL840	Conformance to the following safety standards: <ul style="list-style-type: none"> • Power Conversion Equipment • Insulation Coordination, Including Clearance and Creepage distances of electrical equipment
Designed in compliance with UL60950 (formerly UL1950)	Safety of Information Technology Equipment, Including Electrical Business Equipment
In compliance with EN60204-1	Low Voltage Directive, 73/23/EEC

3.4 CE Mark Conformance

The DMR 50-5/50 servo drive is intended for incorporation in a machine or end product. The actual end product must comply with all safety aspects of the relevant requirements of the European Safety of Machinery Directive 98/37/EC as amended, and with those of the most recent versions of standards EN60204-1 and EN292-2 at the least.

According to Annex III of Article 13 of Council Directive 93/68/EEC, amending Council Directive 73/23/EEC concerning electrical equipment designed for use within certain voltage limits, the DMR 50-5/50 meets the provisions outlined in Council Directive 73/23/EEC. The party responsible for ensuring that the equipment meet the limits required by EMC regulations is the manufacturer of the end product.

3.5 Warranty Information

The products covered in this manual are warranted to be free of defects in material and workmanship and conform to the specifications stated either within this document or in the product catalogue description. All Motor Power Company products are warranted for a period of 12 months from the time of shipment. No other warranties, expressed or implied — and including a warranty of merchantability and fitness for a particular purpose — extend beyond this warranty.

Motor Power Company s.r.l.

Via Leonardo Da Vinci, 4
 42024 Castelnovo Sotto Reggio Emilia - Italia
 Tel. +39 0522 682710 - Fax +39 0522 683552
 info@motorpowerco.it - motorpowerco.com
 Cap. Soc. 250.000,00€ i.v. - R.E.A. di RE 175521
 Iscr.Reg.Impr. di RE n.01308390358 - N. Mecc. RE 010210
 C.F. e P.IVA IT 01308390358



3.6 Drawings

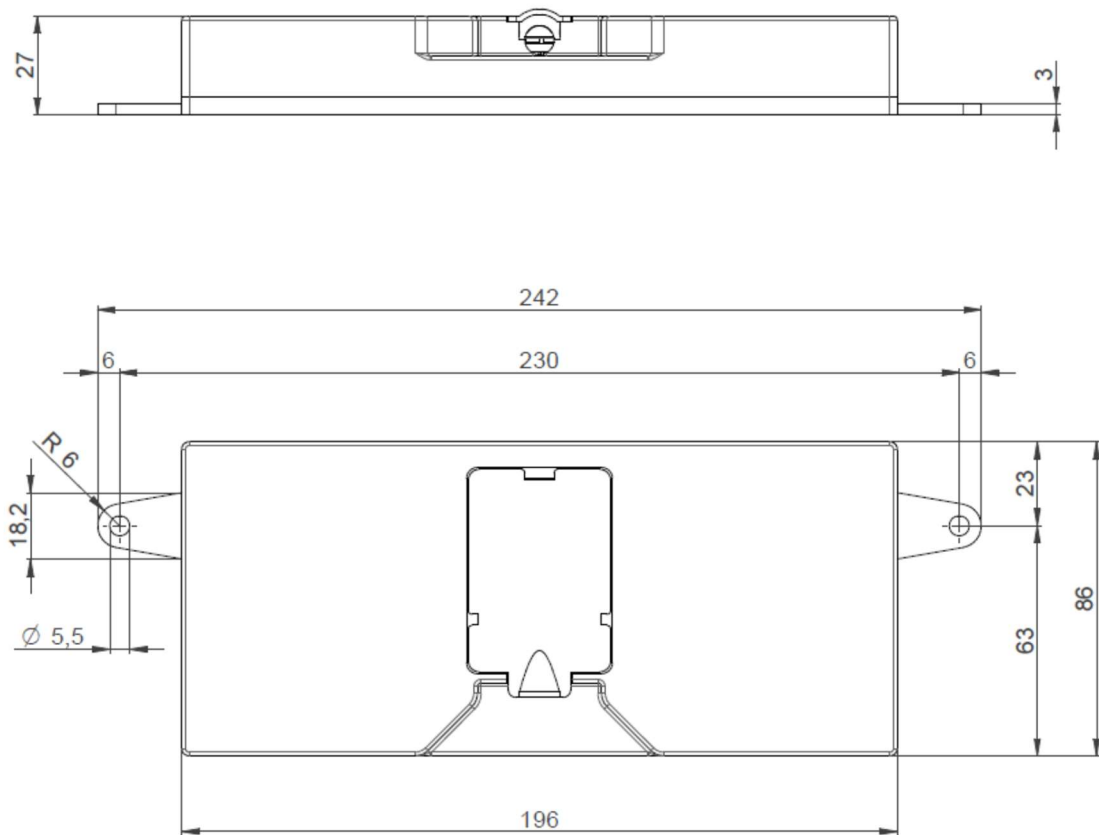

3.7 Typical Installation

The device is designed to be installed on conveyor side



Figure 1: Typical Installation inside side channel

To fix the device to the conveyor side 2 x M5 screw are necessary.

Motor Power Company s.r.l.

Via Leonardo Da Vinci, 4
42024 Castelnovo Sotto Reggio Emilia - Italia
Tel. +39 0522 682710 - Fax +39 0522 683552
info@motorpowerco.it - motorpowerco.com
Cap. Soc. 250.000,00€ i.v. - R.E.A. di RE 175521
Iscr.Reg.Impr. di RE n.01308390358 - N. Mecc. RE 010210
C.F. e P.IVA IT 01308390358

**MOTOR
POWER**
COMPANY

3.8 Specifications

	Description
Logic Supply	24 Vdc +/- 5%
Minimum Supply Voltage	12 Vdc
Nominal Supply Voltage	48 Vdc
Maximum Supply Voltage	60 Vdc
Nominal Current	4 A
Peak Current	15 A
Output Power	240 W
Efficiency @ rated Power	> 90%
PWM Switching Frequency	10 kHz (Max)
Weight	Kg
Dimensions	242x86x27 mm
Mounting Model	Wall Mount on Back side

3.9 Environmental Conditions

	Description
Operating ambient temperature	0° ~ 40° C (32° ~ 104° F)
Storage temperature	-20° ~ +85° C (-4° ~ +185° F)
Humidity	90% maximum non-condensing
Protection level	IP20

Motor Power Company s.r.l.

Via Leonardo Da Vinci, 4
 42024 Castelnovo Sotto Reggio Emilia - Italia
 Tel. +39 0522 682710 - Fax +39 0522 683552
 info@motorpowerco.it - motorpowerco.com
 Cap. Soc. 250.000,00€ i.v. - R.E.A. di RE 175521
 Iscr.Reg.Impr. di RE n.01308390358 - N. Mecc. RE 010210
 C.F. e P.IVA IT 01308390358



3.10 Available Models

Part Number	Description	Note
051700000001	DMR 50-5/50 E C 0	PNP - Available on Request
051700000002	DMR 50-5/50 E C 1	NPN - Available on Request
051700000003	DMR 50-5/50 H C 0	PNP - Standard Configuration
051700000004	DMR 50-5/50 H C 1	NPN - Available on Request

3.10.1 Type Plate



Motor Power Company s.r.l.

Via Leonardo Da Vinci, 4
 42024 Castelnovo Sotto Reggio Emilia - Italia
 Tel. +39 0522 682710 - Fax +39 0522 683552
 info@motorpowerco.it - motorpowerco.com
 Cap. Soc. 250.000,00€ i.v. - R.E.A. di RE 175521
 Iscr.Reg.Impr. di RE n.01308390358 - N. Mecc. RE 010210
 C.F. e P.IVA IT 01308390358



4 Location of Items

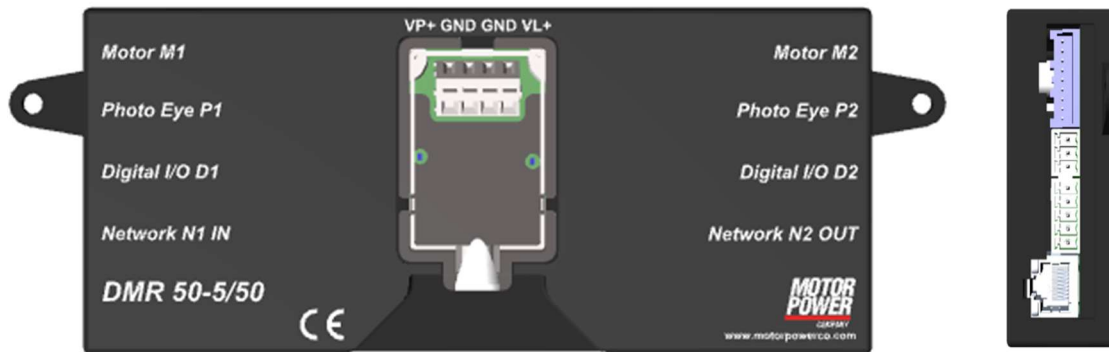

To use correctly the device the following items have to be identified:

Object	Description
XP1	Power Supply Connector
M1,M2	Motor Connector
P1,P2	Photo Eye Connector
D1,D2	Function Connector
N1,N2	Network Connector
L1,L2	Led for Motor1 and Motor2
L3	24V Auxiliary Logic
L4,L5	RJ45 LED

Motor Power Company s.r.l.

Via Leonardo Da Vinci, 4
 42024 Castelnovo Sotto Reggio Emilia - Italia
 Tel. +39 0522 682710 - Fax +39 0522 683552
 info@motorpowerco.it - motorpowerco.com
 Cap. Soc. 250.000,00€ i.v. - R.E.A. di RE 175521
 Iscr.Reg.Impr. di RE n.01308390358 - N. Mecc. RE 010210
 C.F. e P.IVA IT 01308390358

5 Wiring

5.1 Connector XP1 – Power Supply

The Connector Type is WAGO 236-404

The recommended power wires are fine-stranded conductor with ferrule plastic collar 0,25-1,5 mm²

Pin	Function	Description
1	VP+	Power Supply 48Vdc
2	GND	0 Vdc
3	GND	0 Vdc
4	VL+	Logic Supply 24Vdc

48 V dc switched-mode power supply, which can accept an overcurrent to handle the peak for 3 to 5s is recommended.

- The 24 Vdc Logic supply is protected with a 1 A fuse.

	Please provide a power supply that has enough power to in support the application.
---	--

	Use Different power supply for Logic and Power. Motor Regeneration can damage the 24V Input Logic.
---	--

	To avoid Voltage Drop please use always the maximum allowed wire size.
---	--

5.2 Connector M1, M2 – Motor Connector

The connector is JST S09B-XASK-1, the mating connector on motor cable is JST XHP-9.

Pin	Function	Description
1	Mw	Motor Phase w
2	Mv	Motor Phase v
3	Mu	Motor Phase u
4	Gnd	0 Vdc
5	Hu	Hall Sensor u
6	Hv	Hall Sensor v
7	Hw	Hall Sensor w
8	Encoder Power Supply	5 Vdc
9	Thermal Sensor	NTC Thermal sensor Input

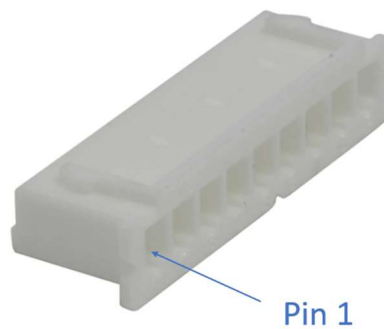

Figure 2: Motor Connector



Extension cables longer than 2 meters can cause voltage drops or distortions of the feedback signals. The device could not work properly.

Motor Power Company s.r.l.

Via Leonardo Da Vinci, 4
42024 Castelnovo Sotto Reggio Emilia - Italia
Tel. +39 0522 682710 - Fax +39 0522 683552
info@motorpowerco.it - motorpowerco.com
Cap. Soc. 250.000,00€ i.v. - R.E.A. di RE 175521
Iscr.Reg.Impr. di RE n.01308390358 - N. Mecc. RE 010210
C.F. e P.IVA IT 01308390358

**MOTOR
POWER**
COMPANY

5.3 Connector P1, P2 - Photo Eye Connector

The connector is Phoenix Contact MC 1,5/ 3-G-3,5 – 1844223, the mating connector is Phoenix Contact MC 1,5/ 3-ST-3,5 – 1840379.

Pin	Function	Description
1	Power Supply	24 V power supply 200mA
2	Photo Eye Input	Input signal
3	Gnd	0 Vdc

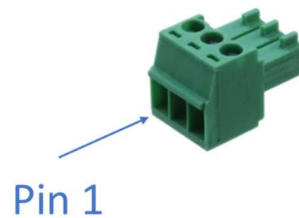
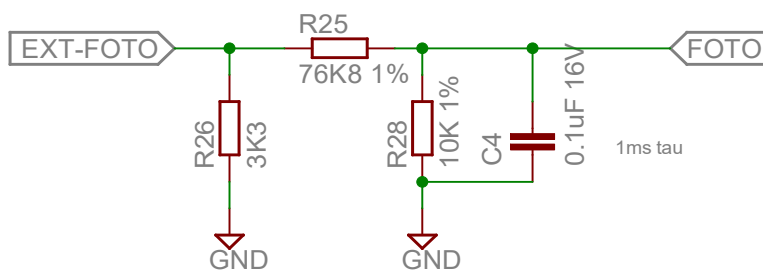

Figure 3: Photo Eye Connector

5.3.1 Photo Eye internal connection



Motor Power Company s.r.l.

Via Leonardo Da Vinci, 4
 42024 Castelnovo Sotto Reggio Emilia - Italia
 Tel. +39 0522 682710 - Fax +39 0522 683552
 info@motorpowerco.it - motorpowerco.com
 Cap. Soc. 250.000,00€ i.v. - R.E.A. di RE 175521
 Iscr.Reg.Impr. di RE n.01308390358 - N. Mecc. RE 010210
 C.F. e P.IVA IT 01308390358

5.4 Connector D1, D2 - Standard Functions Connector

The connector is Phoenix Contact MC 1,5/ 5-G-3,5 – 1844249, the mating connector is Phoenix Contact MC 1,5/ 5-ST-3,5 – 1840395.

Pin	Function	Description	Type
1	Enable	Enable the Motor	Digital Input
2	Dir	Direction of Motor	Digital Input
3	Speed	Velocity of the motor	Analog Input
4	Error	Error on Motor	Digital Output
5	Out1	Out1	Digital Output

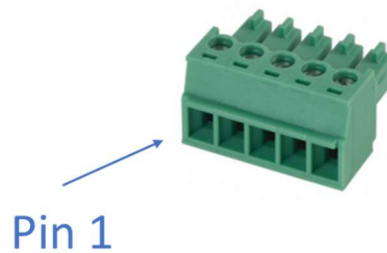

Figure 4: Standard Functions Connector

Motor Power Company s.r.l.

Via Leonardo Da Vinci, 4
 42024 Castelnovo Sotto Reggio Emilia - Italia
 Tel. +39 0522 682710 - Fax +39 0522 683552
 info@motorpowerco.it - motorpowerco.com
 Cap. Soc. 250.000,00€ i.v. - R.E.A. di RE 175521
 Iscr.Reg.Impr. di RE n.01308390358 - N. Mecc. RE 010210
 C.F. e P.IVA IT 01308390358



5.4.1 Digital Input internal wiring

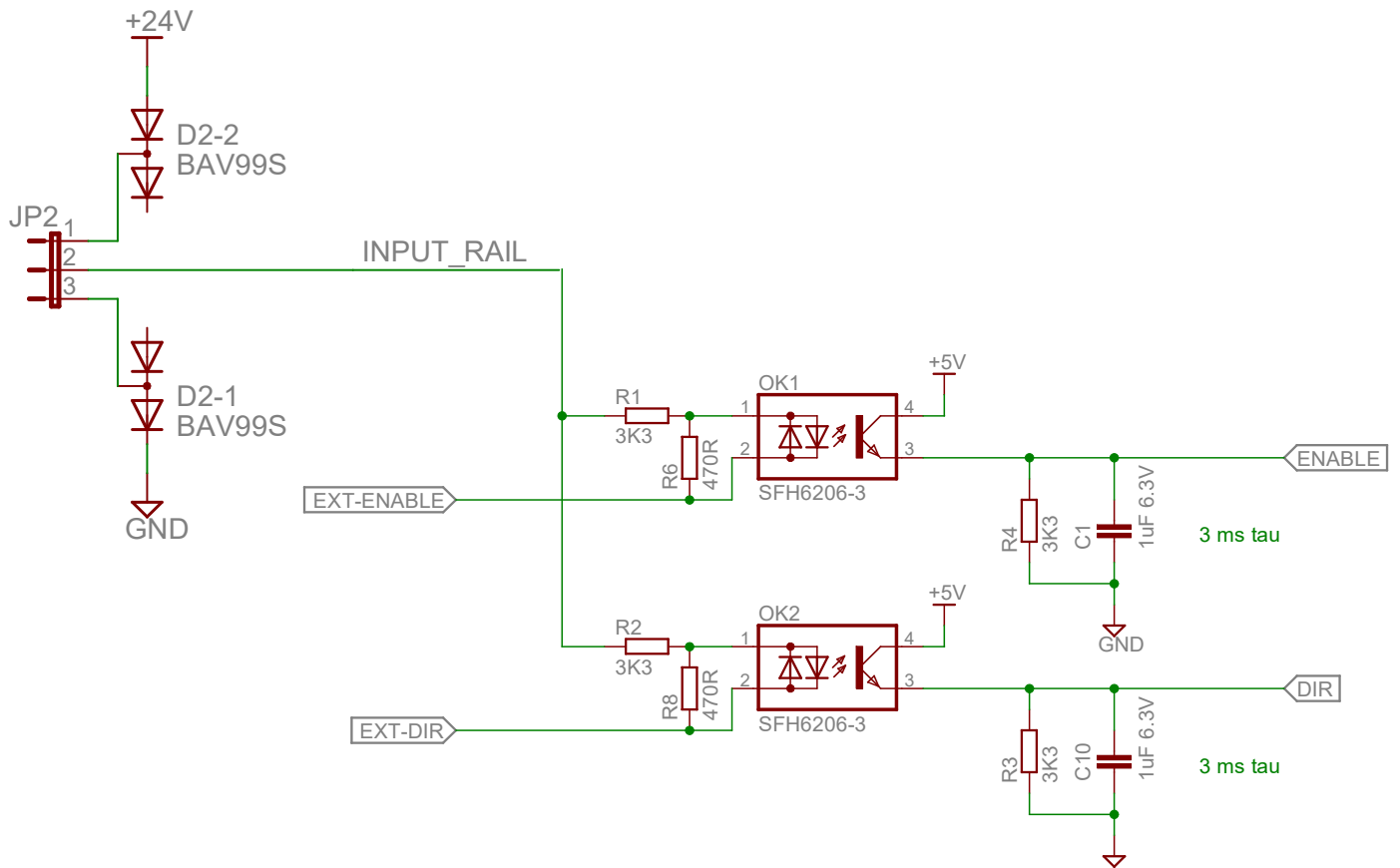

Typical input current @24Vcd is 7,2 mA

5.4.2 Analog Input internal wiring

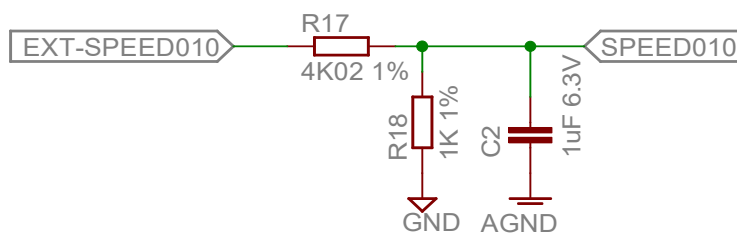

5.4.3 Digital Output Internal wiring

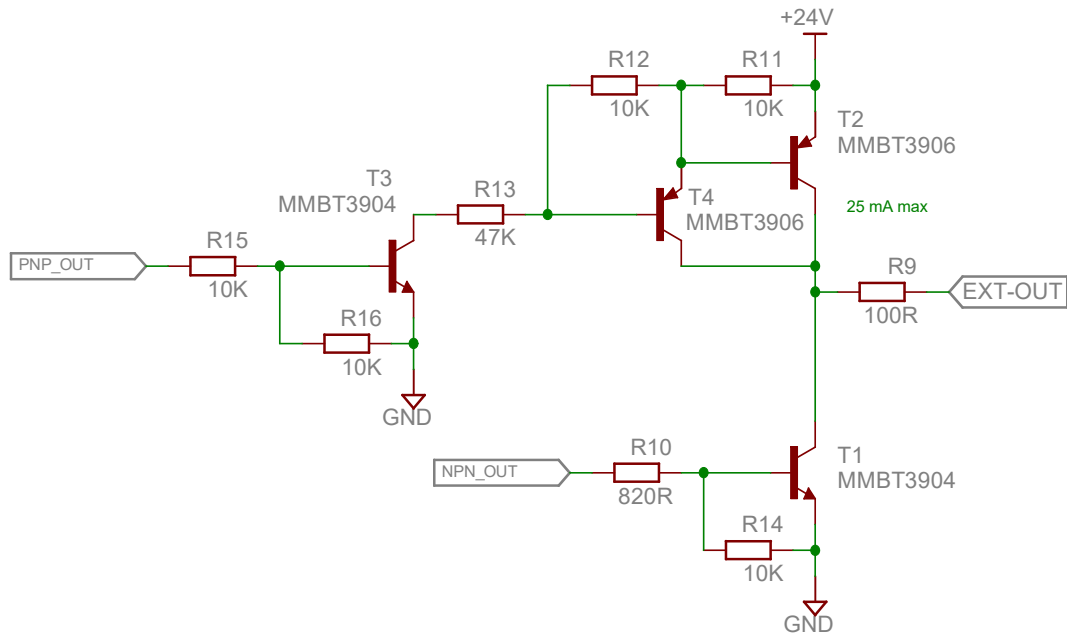

The output maximum current have to be $< 25 \text{ mA}$. To protect the output is suggested to add an external resistance $R > 860 \Omega$.



In the event of a current $\geq 25 \text{ mA}$, there is a risk to damage the output transistor.

Motor Power Company s.r.l.

Via Leonardo Da Vinci, 4
 42024 Castelnovo Sotto Reggio Emilia - Italia
 Tel. +39 0522 682710 - Fax +39 0522 683552
 info@motorpowerco.it - motorpowerco.com
 Cap. Soc. 250.000,00€ i.v. - R.E.A. di RE 175521
 Iscr.Reg.Impr. di RE n.01308390358 - N. Mecc. RE 010210
 C.F. e P.IVA IT 01308390358

**MOTOR
 POWER**
 COMPANY

5.5 Connector N1,N2 - Network Connection

The Connector is a standard RJ45 Female connector, Mating Connector RJ45 Male, is strongly recommended to use connector with metal case.

Pin	Function	Description	Standard RJ-45 cable color
1	CAN H	CAN High	White/Orange
2	CAN L	CAN Low	Orange
3	----	Not Connected	White/Green
4	DATA+	RS 485 DATA+	Blue
5	DATA-	RS 485 DATA-	White/Blue
6	Shield	Shield	Green
7	NC	Not Connected	White Brown
8	DI/DO	Input on N1, Output on N2	Brown



To operate correctly the CAN Bus or the RS485 communications a 120Ω termination resistance must be added at both line side.

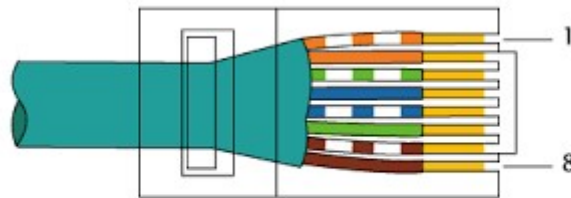

EIA/TIA-568B



Figure 5: Network Connector

Motor Power Company s.r.l.

Via Leonardo Da Vinci, 4
42024 Castelnovo Sotto Reggio Emilia - Italia
Tel. +39 0522 682710 - Fax +39 0522 683552
info@motorpowerco.it - motorpowerco.com
Cap. Soc. 250.000,00€ i.v. - R.E.A. di RE 175521
Iscr.Reg.Impr. di RE n.01308390358 - N. Mecc. RE 010210
C.F. e P.IVA IT 01308390358



6 Connection schematic

	<p>Warning: Before commissioning, it is essential that the safety instructions in the relevant section are read and understood, and then observed! Non-observance can result in danger to persons or damage to the equipment.</p> <p>Disconnect the electrical power supply before any operation on the device.</p>
	<p>CAUTION: Incorrect connection of motor power electronics. The motor is not equipped with reverse polarity protection. Consequence: Destroying of the power electronics possible.</p> <p>Check the right polarity.</p>
	<p>NOTICE: Loops must be avoided for all grounding concepts. Shielded cable must be used for the whole cable system without interruption. Up to a length of 10m a common power and signal cable can be used. If the cable is longer than 10m it is recommended to separate power and signal in different shielded cables. When standard wires from Motor Power Company are used, the shielding must be spaciouly applied inside the control cabinet.</p>

Failure to follow them can result in danger to persons or damage to the equipment.

Motor Power Company s.r.l.

Via Leonardo Da Vinci, 4
42024 Castelnovo Sotto Reggio Emilia - Italia
Tel. +39 0522 682710 - Fax +39 0522 683552
info@motorpowerco.it - motorpowerco.com
Cap. Soc. 250.000,00€ i.v. - R.E.A. di RE 175521
Iscr.Reg.Impr. di RE n.01308390358 - N. Mecc. RE 010210
C.F. e P.IVA IT 01308390358



6.1 Schematic circuit for power and logic supply

	<p>CAUTION: Peak current by switching-on of a variety of series-connected motors.</p> <p>Consequence: Destroying of the integrated electronics possible.</p> <p>► Using an adequate power supply.</p>
---	--

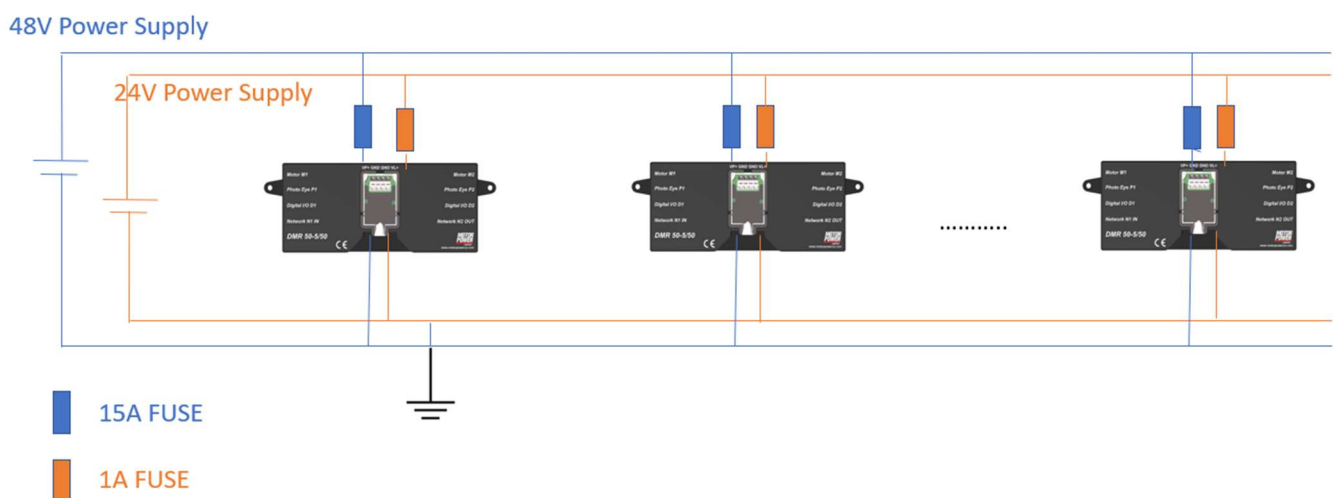

Figure 6: Power supply schematic

The number of devices you can daisy chain depends on the application, the wire size and the power supply.

7 Default I/O Functionality

7.1 Run/Stop

This is the signal to use to enable/disable the Device. Please consider that for encoder version 1s delay have to be considered at the first startup, to allow the current phase identification.

Once the Device is enabled this will follow immediately the V-IN setpoint.

Motor Power Company s.r.l.

Via Leonardo Da Vinci, 4
42024 Castelnovo Sotto Reggio Emilia - Italia
Tel. +39 0522 682710 - Fax +39 0522 683552
info@motorpowerco.it - motorpowerco.com
Cap. Soc. 250.000,00€ i.v. - R.E.A. di RE 175521
Iscr.Reg.Impr. di RE n.01308390358 - N. Mecc. RE 010210
C.F. e P.IVA IT 01308390358



7.2 DIR – Direction of Rotation

The default Direction of rotation is clock wise Motor A Flange if the DIR pin is set to Low.

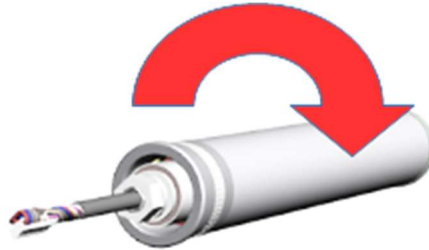

7.3 V-IN – Speed Variation

Speed variation by an external analogue voltage from 0 to 10Vdc.

All the voltage above 10Vdc will be clamped to the 10Vdc value.

The default gains is applied 10 Vdc -> 800 rpm, and also the speed profiled is enable limiting the acceleration to 0,4 g (considering a roller diameter of 50 mm)



Be careful to not exceed the 24Vdc to not damage the analogue input.



Connect all the 0 VDC points of the external analogue power supply to the 0 Vdc of the XP1 connector

7.4 ERR – Error Signal

The signal is High when no error is present and Low when we have an error condition.

	<p>When powering on and off, the error signal could be set. Do not consider this signal during 0.5s to power on, and 2s to power off.</p>
---	---

7.5 Customized I/O configuration

It's possible using the Modbus RTU protocol or the Standard GUI to modify the digital input and output capability and logic levels of all the I/O present on the device. Please refer to the Software Manual to explore all the possible options.

Motor Power Company s.r.l.

Via Leonardo Da Vinci, 4
 42024 Castelnovo Sotto Reggio Emilia - Italia
 Tel. +39 0522 682710 - Fax +39 0522 683552
 info@motorpowerco.it - motorpowerco.com
 Cap. Soc. 250.000,00€ i.v. - R.E.A. di RE 175521
 Iscr.Reg.Impr. di RE n.01308390358 - N. Mecc. RE 010210
 C.F. e P.IVA IT 01308390358



8 LED Configuration

On the Device 7 LED are present, not all are used. Here below you can find the position and the functions related to each one.

8.1 LED Map

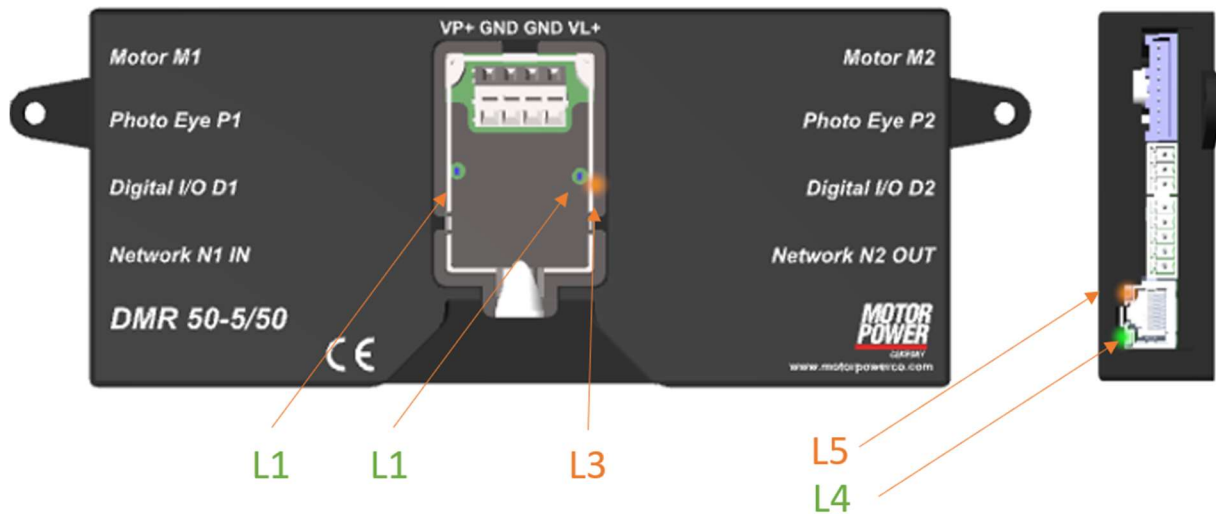

LED	Color	Function	Note
L1	Green	Axis M1 Status	
L2	Green	Axis M2 Status	
L3	Orange	Power Supply Status	
L4	Green	Not Used	Same on both RJ-45*
L5	Orange	Device Status	Same on both RJ-45*

(* Please note that on the other side the RJ-45 LEDs are swapped)

Motor Power Company s.r.l.

Via Leonardo Da Vinci, 4
42024 Castelnovo Sotto Reggio Emilia - Italia
Tel. +39 0522 682710 - Fax +39 0522 683552
info@motorpowerco.it - motorpowerco.com
Cap. Soc. 250.000,00€ i.v. - R.E.A. di RE 175521
Iscr.Reg.Impr. di RE n.01308390358 - N. Mecc. RE 010210
C.F. e P.IVA IT 01308390358



8.2 L1 and L2 Axis Status

The LED L1 and L2 show the axis status.

STATUS	DESCRIPTION
Blinking Fast	Axis OK and Disabled
Solid Green	Axis Enabled
Off	Axis Fault

8.3 L3 Auxiliary Power Supply Status

The LED L3 show the Auxiliary Power Supply Status.

STATUS	DESCRIPTION
Solid Green	Auxiliary Power Supply Ok
Off	No Logic Power Supply – Device Off

8.4 L5 Device Status

The LED L5 show the Device Status Status.

STATUS	DESCRIPTION
Switch off	Device Ok
Blinking	Fault occurred
Solid Orange	Device in Bootloader Mode

Motor Power Company s.r.l.

Via Leonardo Da Vinci, 4
42024 Castelnovo Sotto Reggio Emilia - Italia
Tel. +39 0522 682710 - Fax +39 0522 683552
info@motorpowerco.it - motorpowerco.com
Cap. Soc. 250.000,00€ i.v. - R.E.A. di RE 175521
Iscr.Reg.Impr. di RE n.01308390358 - N. Mecc. RE 010210
C.F. e P.IVA IT 01308390358



9 Information on the motor

9.1 Motor Phase Angle

For a correct operation, the motor must have a correct electrical configuration.

Specification	Value
Speed	1000 rpm
Direction	Clockwise (A Motor Flange/Cable Side)
Reference Voltage	Concatenate
Tolerance	+/- 20 Electrical degrees

The electrical configuration must follow this schema:

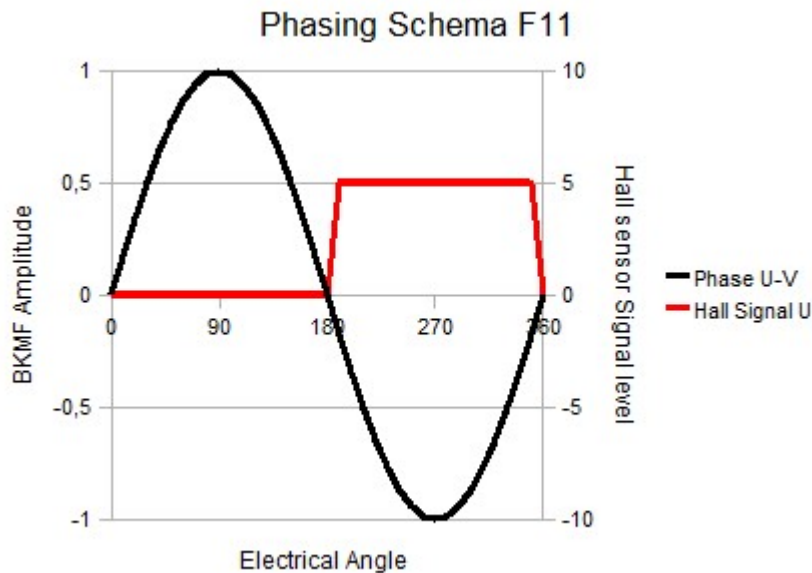

Every hall signal must be referred to the proper reference voltage:

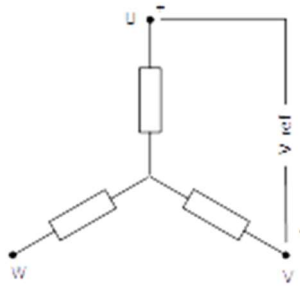

Reference Voltage	Hall Signal Value
U-V	Hall Signal U
V-W	Hall Signal V
W-U	Hall Signal W

9.2 Hall signal sequence

Hall sensor follow a grey code sequence. Rotating the motor Clockwise (front flange) we must find this configuration.

Value	Hall U	Hall V	Hall W
1	0	0	1
3	0	1	1
2	0	1	0
6	1	1	0
4	1	0	0
5	1	0	1

Motor Power Company s.r.l.

Via Leonardo Da Vinci, 4
 42024 Castelnovo Sotto Reggio Emilia - Italia
 Tel. +39 0522 682710 - Fax +39 0522 683552
 info@motorpowerco.it - motorpowerco.com
 Cap. Soc. 250.000,00€ i.v. - R.E.A. di RE 175521
 Iscr.Reg.Impr. di RE n.01308390358 - N. Mecc. RE 010210
 C.F. e P.IVA IT 01308390358

**MOTOR
 POWER**
 COMPANY

9.3 Motor Phase Sequence

Rotating clock-wise from motor A flange

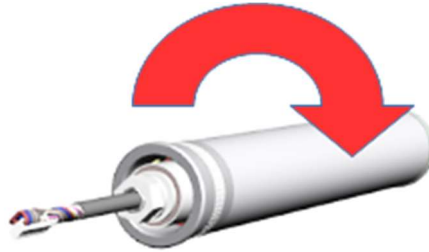

Figure 7: Motor Direction

this is the correct phase sequence

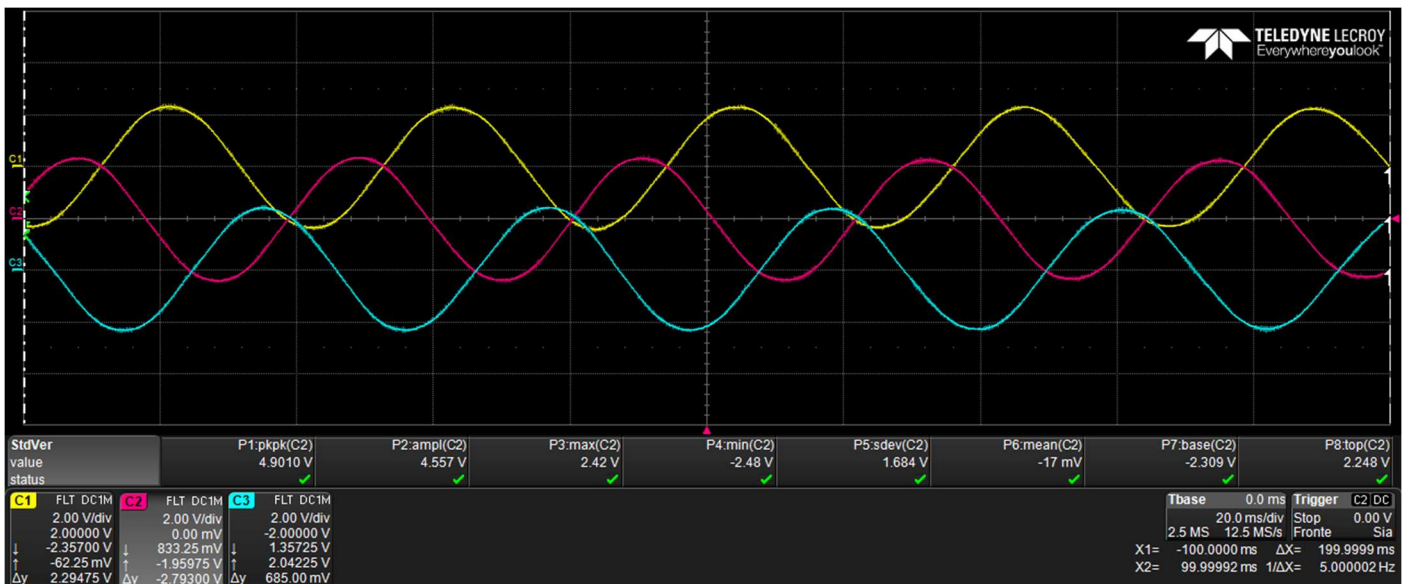

Image 1

Where:

C1 = Phase U, C2 = Phase V, C3 = Phase W

Motor Power Company s.r.l.

Via Leonardo Da Vinci, 4
 42024 Castelnovo Sotto Reggio Emilia - Italia
 Tel. +39 0522 682710 - Fax +39 0522 683552
 info@motorpowerco.it - motorpowerco.com
 Cap. Soc. 250.000,00€ i.v. - R.E.A. di RE 175521
 Iscr.Reg.Impr. di RE n.01308390358 - N. Mecc. RE 010210
 C.F. e P.IVA IT 01308390358



10 Standard Configuration Interface

10.1 Setup for Modbus RTU

Our standard USB to RS485 converter is **USB2-H-5001-M** that can be found on any major distributor web site, or you can buy from Motor Power Company . Any other converter with same capability can be used.

Below the correct dip-switch configuration.



Figure 8: USB adapter dip switch



If the dip-switch will not have the proper configuration you will not be able to communicate with the device.

With standard RJ-45 cables this is the correct color sequence.

Motor Power Company s.r.l.

Via Leonardo Da Vinci, 4
42024 Castelnovo Sotto Reggio Emilia - Italia
Tel. +39 0522 682710 - Fax +39 0522 683552
info@motorpowerco.it - motorpowerco.com
Cap. Soc. 250.000,00€ i.v. - R.E.A. di RE 175521
Iscr.Reg.Impr. di RE n.01308390358 - N. Mecc. RE 010210
C.F. e P.IVA IT 01308390358

**MOTOR
POWER**
COMPANY

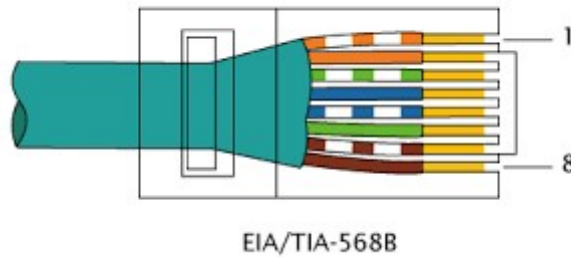

If you don't have these wire color, please follow the N1,N2 connection schema.

Cable and USB adapter are available at Motor Power Company with the following Part Numbers:

005016000175 : CONVERTITORE INTERFACCIA PC USB/485 USB2-H-5001-M

003016000668 : CAVO-SERIALE DI COMUN. RS485 x AZ. DMR 2m

10.2 Standard communication parameters

The standard configuration for the Modbus RTU communication is:

Data	Value
Baud Rate	460.800
Data Bit	8
Stop Bit	1
Parity	No
Default Node	247

Motor Power Company s.r.l.

Via Leonardo Da Vinci, 4
42024 Castelnovo Sotto Reggio Emilia - Italia
Tel. +39 0522 682710 - Fax +39 0522 683552
info@motorpowerco.it - motorpowerco.com
Cap. Soc. 250.000,00€ i.v. - R.E.A. di RE 175521
Iscr.Reg.Impr. di RE n.01308390358 - N. Mecc. RE 010210
C.F. e P.IVA IT 01308390358

