

Installation guide

DMR PC 6-50

V2

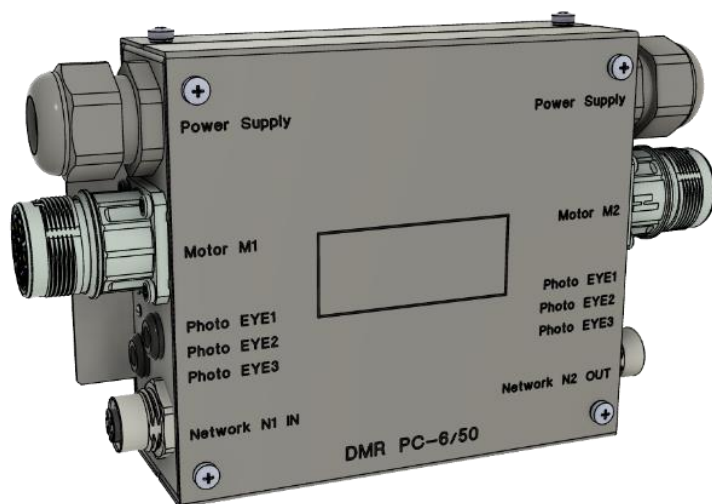

Motor Power Company s.r.l.

Via Leonardo Da Vinci, 4
42024 Castelnovo Sotto Reggio Emilia - Italia
Tel. +39 0522 682710 - Fax +39 0522 683552
info@motorpowerco.it - motorpowerco.com
Cap. Soc. 250.000,00€ i.v. - R.E.A. di RE 175521
Iscr.Reg.Impr. di RE n.01308390358 - N. Mecc. RE 010210
C.F. e P.IVA IT 01308390358

**MOTOR
POWER**
COMPANY

Motor Power Company s.r.l.

Via Leonardo Da Vinci, 4
42024 Castelnovo Sotto Reggio Emilia - Italia
Tel. +39 0522 682710 - Fax +39 0522 683552
info@motorpowerco.it - motorpowerco.com
Cap. Soc. 250.000,00€ i.v. - R.E.A. di RE 175521
Iscr.Reg.Impr. di RE n.01308390358 - N. Mecc. RE 010210
C.F. e P.IVA IT 01308390358



1 Index

1	Index.....	3
2	Product Presentation	7
	General Description.....	7
3	Safety Information.....	9
	Warnings	9
	Cautions.....	10
	Directives and Standards	11
	CE Mark Conformance	11
	Warranty Information.....	11
	Drawings	12
	Typical Installation.....	13
	Specifications	13
	Environmental Conditions	14
	Connectors/IOs.....	14
	PROFINET RT	14
	Ethernet/IP	16
	EtherCAT	16
	Compatible Motors.....	17
	Available Models	17
	Type Plate:	17
4	Location of Items and connectors	18
5	Wiring.....	19
	Open the box.....	19
	Power Supply PG – Power Supply internal connector	20
	Connector M1, M2 – Motor Connector	21
	M23 connector.....	21
	M15 connector.....	22
	Internal Connections	22
	Photo Eye PG and Internal Connector	24
	Photo Eye internal connection	25
	Internal I/O Connector (Optional).....	25
	Digital Input internal wiring	26

Analog Input internal wiring	26
Digital Output Internal wiring	27
Connector N1,N2 - Network Connection	28
Internal RS-485 connector (For Debug).....	30
6 Connection schematic.....	31
Schematic circuit for power and logic supply	32
7 Default I/O Functionality (Optional)	33
Run/Stop	33
DIR – Direction of Rotation	34
V-IN – Speed Variation	34
ERR – Error Signal	35
Customized I/O configuration	35
8 LED Configuration	36
LED Map.....	36
L1 and L2 Axis Status	37
L3 Auxiliary Power Supply Status	37
Internal LED	38
9 Information on the motor	39
Motor Phase Angle	39
Hall signal sequence.....	40
Motor Phase Sequence.....	41
10 Standard Configuration Interface	42
Setup for Modbus RTU.....	42
Standard communication parameters.....	44
Connecting to the UI	44
UI basic operations	45
FW Upgrade.....	45
Parameters storing/saving.....	45
IOs configuration.....	46
Conversion Factors	49
11 Protective Functions.....	50
Undervoltage Switch-Off of the Power-	50
Overvoltage Switch-Off of the Power-.....	50

Motor Power Company s.r.l.

Via Leonardo Da Vinci, 4
 42024 Castelnovo Sotto Reggio Emilia - Italia
 Tel. +39 0522 682710 - Fax +39 0522 683552
 info@motorpowerco.it - motorpowerco.com
 Cap. Soc. 250.000,00€ i.v. - R.E.A. di RE 175521
 Iscr.Reg.Impr. di RE n.01308390358 - N. Mecc. RE 010210
 C.F. e P.IVA IT 01308390358



Overtemperature Protection50
Current limitation.....50
Fuses.....52
Protection Threshold Values52

Notice:

This guide delivered subject to the following conditions and restrictions: This guide contains proprietary information belonging to Motor power Company Srl. Such information is supplied solely for the purpose of assisting users of the DMR PC 6/50 H X servo drive in its installation and configuration.

The text and graphics included in this manual are for the purpose of illustration and reference only. The specifications on which they are based are subject to change without notice.

Motor power Company and the Motor power Company logo are trademarks of Motor power Company Srl.

Information in this document is subject to change without notice.



Version	Date	Author	Note
1.0	01/11/2022	Piccinelli, Piacentini	Initial Release
2.0	01/04/2023	Piacentini	

Motor Power Company s.r.l.

Via Leonardo Da Vinci, 4
42024 Castelnovo Sotto Reggio Emilia - Italia
Tel. +39 0522 682710 - Fax +39 0522 683552
info@motorpowerco.it - motorpowerco.com
Cap. Soc. 250.000,00€ i.v. - R.E.A. di RE 175521
Iscr.Reg.Impr. di RE n.01308390358 - N. Mecc. RE 010210
C.F. e P.IVA IT 01308390358



2 Product Presentation

General Description

The DMR PC 6/50 H X is a servo drive especially designed for Motor Power Company Pallet Conveyor solutions.

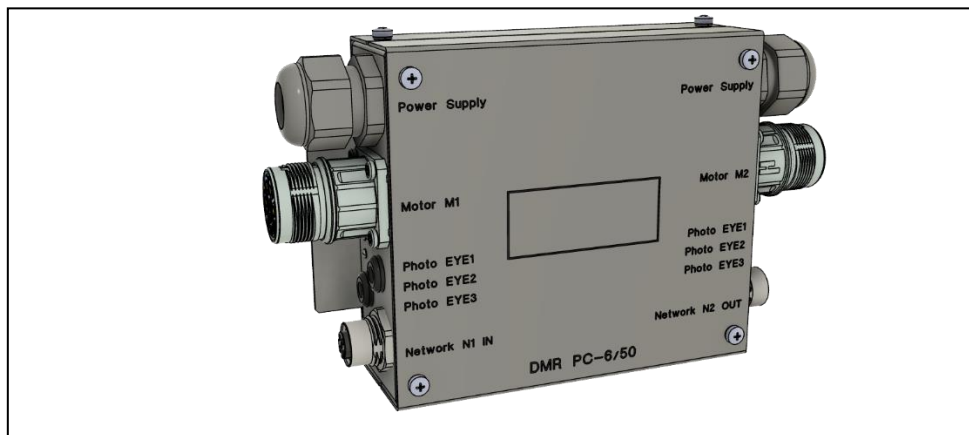

FIGURE 1:DEVICE

The Device is able to operate one or 2 different devices independently, and is compatible with Motoroller size 50 and Pallet Conveyor size 70 and 89.

This guide is intended to describe the installation and commissioning the following products:

Part Number	Product code	Fieldbus Type
DMR PC-6/50 H P X	051700000004	PROFINET RT
	051700000006	
DMR PC-6/50 H E X	051700000005	EtherCAT
	051700000007	
DMR PC-6/50 H EI X	051700000009	EtherNet/IP
	051700000008	

Pallet conveyor Drive is a Brushless motor drive that can operate in different mode and with many fieldbus:

- Position Mode (DS402)
- Velocity Mode (DS402)
- Current Mode (DS402)

Motor Power Company s.r.l.

Via Leonardo Da Vinci, 4
 42024 Castelnovo Sotto Reggio Emilia - Italia
 Tel. +39 0522 682710 - Fax +39 0522 683552
 info@motorpowerco.it - motorpowerco.com
 Cap. Soc. 250.000,00€ i.v. - R.E.A. di RE 175521
 Iscr.Reg.Impr. di RE n.01308390358 - N. Mecc. RE 010210
 C.F. e P.IVA IT 01308390358



The DMR PC can be controlled in several ways:

- PROFINET IO
- EtherNet/IP
- EtherCAT
- IOs (analog In 2 IN, 2 OUT and 3 PHEYE per axis)

The Control&Programming Manual describe the commissioning of the DMR with Ethernet based fielbus.

A commissioning User Interface software with serial communication can be used to install and configure the device.

Motor Power Company s.r.l.

Via Leonardo Da Vinci, 4
42024 Castelnovo Sotto Reggio Emilia - Italia
Tel. +39 0522 682710 - Fax +39 0522 683552
info@motorpowerco.it - motorpowerco.com
Cap. Soc. 250.000,00€ i.v. - R.E.A. di RE 175521
Iscr.Reg.Impr. di RE n.01308390358 - N. Mecc. RE 010210
C.F. e P.IVA IT 01308390358



**MOTOR
POWER**
COMPANY

3 Safety Information



In order to achieve the optimum, safe operation of the MDR servo drive, it is imperative that you implement the safety procedures included in this installation guide. This information is provided to protect you and to keep your work area safe when operating the MDR and accompanying equipment. Please read this chapter carefully before you begin the installation process. Before you start, ensure that all system components are connected to earth ground.

Electrical safety is provided through a low-resistance earth connection. Only qualified personnel may install, adjust, maintain and repair the servo drive. A "qualified person" has the knowledge and authorization to perform tasks such as transporting, assembling, installing, commissioning and operating motors.

The DMR servo drive contains electrostatic-sensitive components that can be damaged if handled incorrectly. To prevent any electrostatic damage, avoid contact with highly insulating materials, such as plastic film and synthetic fabrics. Place the product on a conductive surface and ground yourself in order to discharge any possible static electricity build-up. To avoid any potential hazards that may cause severe personal injury or damage to the product during operation, keep all covers and cabinet doors shut. The following safety symbols are used in this manual:

	Warning: This information is needed to avoid a safety hazard, which might cause bodily injury.
	Caution: This information is necessary for preventing damage to the product or to other equipment.
	Note: This is auxiliary information that ensures the correct operation of the equipment.



Warnings

	To avoid electric hazards to personnel and electrical contacts, never connect/disconnect the servo drive while the power source is on.
	Power cables can carry a high voltage, even when the motor is not in motion. Disconnect the DMR PC 6/50 H X from all voltage sources before it is open for servicing.





Motor Power Company s.r.l.

Via Leonardo Da Vinci, 4
42024 Castelnovo Sotto Reggio Emilia - Italia
Tel. +39 0522 682710 - Fax +39 0522 683552
info@motorpowerco.it - motorpowerco.com
Cap. Soc. 250.000,00€ i.v. - R.E.A. di RE 175521
Iscr.Reg.Impr. di RE n.01308390358 - N. Mecc. RE 010210
C.F. e P.IVA IT 01308390358

**MOTOR
POWER**
COMPANY

	The DMR PC 6/50 H X servo drive contains grounding conduits for electric current protection. Any disruption to these conduits may cause the device to become "hot" (live) and dangerous.
	After shutting off the power and removing the power source from your equipment, wait at least 3 minute before touching or disconnecting parts of the equipment that are normally loaded with electrical charges (such as capacitors or contacts). Measuring the electrical contact points with a meter before touching the equipment is recommended.

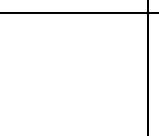
Cautions

	The DMR PC 6/50 H X servo drive contains hot surfaces and electrically-charged components during operation.
	The maximum DC power supply connected to the instrument must comply with the parameters outlined in this guide.
	The DMR PC 6/50 H X servo drive must be connected to an approved 24VDC auxiliary power supply through a line that is separated from hazardous line voltages using reinforced or double insulation in accordance with approved safety standards.
	The DMR PC 6/50 H X series is designed to gets its power from a 48 VDC power source. Power to this device must be supplied by DC voltage, within the boundaries specified for the DMR. High voltages may damage the drive. The DC power supply voltage range is defined in this manual. Safety margins must be considered in order to avoid activating the under or over-voltage protection against line variations and/or voltage drop under load. The transformer should be able to deliver the required power to the drive (including peak power) without significant voltage drops (10% maximum). While driving high-inertia loads, the power supply circuit must be equipped with a shunt regulator; otherwise, the drive will be disabled whenever the capacitors are charged above the maximum voltage
	Before switching on the DMR, verify that all safety precautions have been observed and that the installation procedures in this manual have been followed.

Motor Power Company s.r.l.

Via Leonardo Da Vinci, 4
42024 Castelnovo Sotto Reggio Emilia - Italia
Tel. +39 0522 682710 - Fax +39 0522 683552
info@motorpowerco.it - motorpowerco.com
Cap. Soc. 250.000,00€ i.v. - R.E.A. di RE 175521
Iscr.Reg.Impr. di RE n.01308390358 - N. Mecc. RE 010210
C.F. e P.IVA IT 01308390358

**MOTOR
POWER**
COMPANY

Directives and Standards

The DMR PC 6/50 H X servo drive conforms to the following industry safety standards:

Safety Standard	Item
Designed in Compliance with UL508c and UL840	Conformance to the following safety standards: Power Conversion Equipment Insulation Coordination, Including Clearance and Creepage distances of electrical equipment
Designed in compliance with UL60950 (formerly UL1950)	Safety of Information Technology Equipment, Including Electrical Business Equipment
In compliance with EN60204-1	Low Voltage Directive, 73/23/EEC

CE Mark Conformance

The DMR PC 6/50 H X servo drive is intended for incorporation in a machine or end product. The actual end product must comply with all safety aspects of the relevant requirements of the European Safety of Machinery Directive 98/37/EC as amended, and with those of the most recent versions of standards EN60204-1 and EN292-2 at the least.

According to Annex III of Article 13 of Council Directive 93/68/EEC, amending Council Directive 73/23/EEC concerning electrical equipment designed for use within certain voltage limits, the DMR PC 6/50 H X meets the provisions outlined in Council Directive 73/23/EEC. The party responsible for ensuring that the equipment meet the limits required by EMC regulations is the manufacturer of the end product.

Warranty Information

The products covered in this manual are warranted to be free of defects in material and workmanship and conform to the specifications stated either within this document or in the product catalogue description. All Motor Power Company products are warranted for a period of 12 months from the time of shipment. No other warranties, expressed or implied — and including a warranty of merchantability and fitness for a particular purpose — extend beyond this warranty.

Motor Power Company s.r.l.

Via Leonardo Da Vinci, 4
42024 Castelnovo Sotto Reggio Emilia - Italia
Tel. +39 0522 682710 - Fax +39 0522 683552
info@motorpowerco.it - motorpowerco.com
Cap. Soc. 250.000,00€ i.v. - R.E.A. di RE 175521
Iscr.Reg.Impr. di RE n.01308390358 - N. Mecc. RE 010210
C.F. e P.IVA IT 01308390358



Drawings

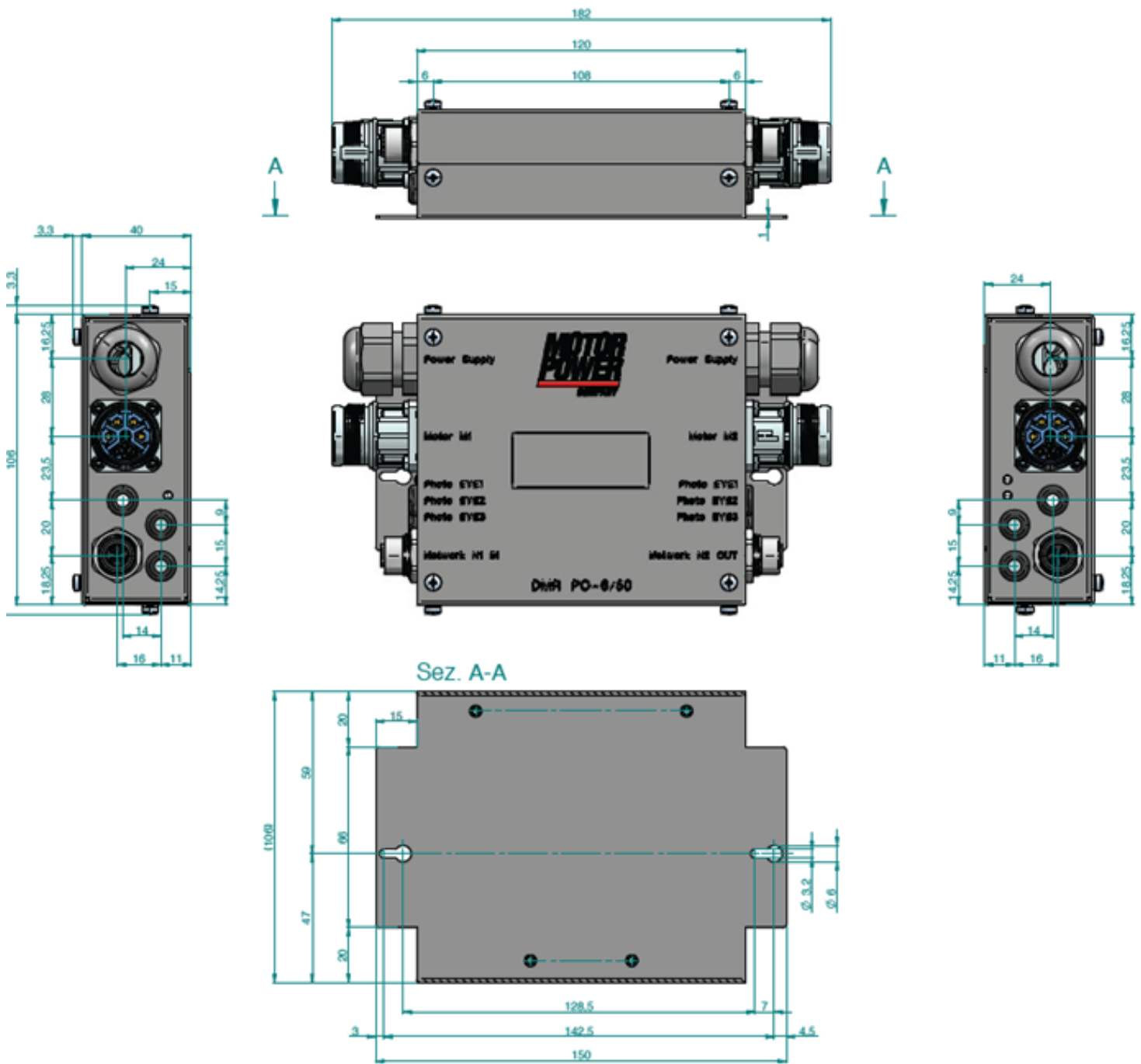

FIGURE 2: DMR PC DIMENSIONS

Typical Installation

The device is designed to be installed on conveyor side

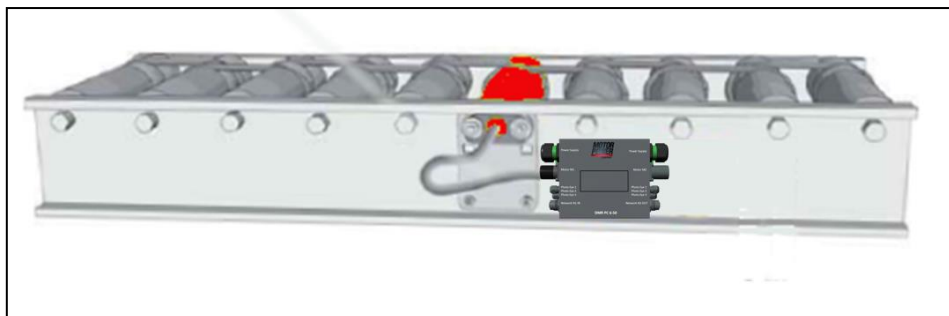

FIGURE 3: TYPICAL INSTALLATION INSIDE SIDE CHANNEL

To fix the device to the conveyor side 2 x M3 screw are necessary.

Specifications

	Description
Logic Supply Voltage	24 Vdc +/- 5%
Maximum Logic supply voltage	36 Vdc +/- 5%
Minimum Logic supply voltage	12 Vdc +/- 5%
Logic Supply Consumption	200mA Maximum
Minimum Power Supply Voltage	12 Vdc
Nominal Power Supply Voltage	48 Vdc
Maximum Power Supply Voltage	60 Vdc
Nominal Current Motor	6 A (for each motor plugged)
Peak Current Motor	15 A (for each motor plugged)
Output Power	335 W (for each motor plugged)
Efficiency @ rated Power	> 90%
PWM Switching Frequency	10 kHz (Max)

Motor Power Company s.r.l.

Via Leonardo Da Vinci, 4
42024 Castelnovo Sotto Reggio Emilia - Italia
Tel. +39 0522 682710 - Fax +39 0522 683552
info@motorpowerco.it - motorpowerco.com
Cap. Soc. 250.000,00€ i.v. - R.E.A. di RE 175521
Iscr.Reg.Impr. di RE n.01308390358 - N. Mecc. RE 010210
C.F. e P.IVA IT 01308390358

Weight	0,68 Kg
Dimensions	173x105,5x45 mm
Mounting Model	Wall Mount on Back side

Environmental Conditions

	Description
Operating ambient temperature	0° ~ 40° C (32° ~ 104° F)
Storage temperature	-20° ~ +85° C (-4° ~ +185° F)
Humidity	90% maximum non-condensing
Protection level	IP20

Connectors/IOs

	Description
Logic Supply	PG 13 on box + on board connector
Power Supply	PG 13 on box + on board connector
Ethernet	M12, 4-pin D coded
Motor Channel	M23, 9-pin
Photo Eyes	PG 7 on box + on board connector
Number of Photo Eyes	6
Number of Outputs	4 NPN/PNP at request
Number of Analog Inputs	2 (0...10V)
Number of Inputs	4+2* NPN/PNP

*Analog inputs can be used as inputs 0 to 24V if needed.

PROFINET RT

	Description
PROFINET specification	V2.35
Conformance Class	2.35

MinCycle Time	1 ms (Ios update limited to 2ms)
Topology Detection	Supported
Automatic Address Setting	Supported
Acyclic communication	Supported
MRP Client	Supported
Diagnostics	Supported
Network Load Class	3
Fast Startup	Supported

Motor Power Company s.r.l.

Via Leonardo Da Vinci, 4
42024 Castelnovo Sotto Reggio Emilia - Italia
Tel. +39 0522 682710 - Fax +39 0522 683552
info@motorpowerco.it - motorpowerco.com
Cap. Soc. 250.000,00€ i.v. - R.E.A. di RE 175521
Iscr.Reg.Impr. di RE n.01308390358 - N. Mecc. RE 010210
C.F. e P.IVA IT 01308390358



Ethernet/IP

	Description
Address Assingment	DHCP/BOOTP supported
DLR	Supported
Quick Connect	Supported
ACP	Supported
UCMM	Supported
Explicit Messages	Connected (class 3) and unconnected
Number of TCP connections	3
Number of CIP connections	10
Input assembly instance	100
Output assembly instance	101
Configuration assembly Instance	102

EtherCAT

	Description
Type	Complex Slave
Acyclic communication (CoE)	SDO supported
SDO client and server side protocol	Supported
CoE emergency messages (CoE stack)	Supported
File Access over EtherCAT (FoE)	Supported
CoE	Supported
Support of Synchronization Modes	Free run mode. Max update time 2ms.

Motor Power Company s.r.l.

Via Leonardo Da Vinci, 4
42024 Castelnovo Sotto Reggio Emilia - Italia
Tel. +39 0522 682710 - Fax +39 0522 683552
info@motorpowerco.it - motorpowerco.com
Cap. Soc. 250.000,00€ i.v. - R.E.A. di RE 175521
Iscr.Reg.Impr. di RE n.01308390358 - N. Mecc. RE 010210
C.F. e P.IVA IT 01308390358



Compatible Motors

	Description
MTR.PP.70.045.01 R1:35 Pallet Conveyor	www.motorpowerco.it for more info
MTR.PP.89.045.04 R1:51 Pallet Conveyor	www.motorpowerco.it for more info

Available Models

Description	Part Number	Fieldbus Type
DMR PC-6/50 H P X	051700000004	PROFINET RT
	051700000006	
DMR PC-6/50 H E X	051700000005	EtherCAT
	051700000007	
DMR PC-6/50 H EI X	051700000009	EtherNet/IP
	051700000008	

Type Plate:

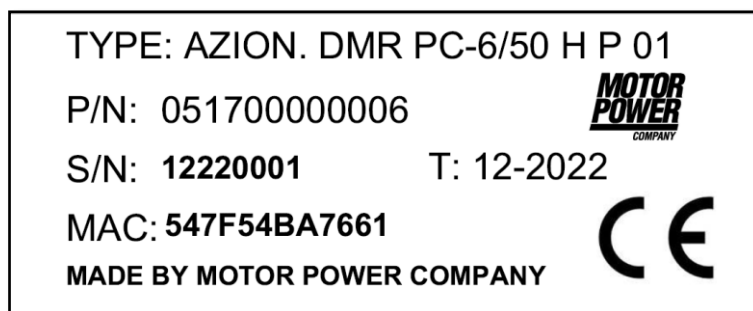

From top to bottom:

- Product description
- Part number of device
- Serial number of device
- MAC ADDRESS

Motor Power Company s.r.l.

Via Leonardo Da Vinci, 4
 42024 Castelnovo Sotto Reggio Emilia - Italia
 Tel. +39 0522 682710 - Fax +39 0522 683552
 info@motorpowerco.it - motorpowerco.com
 Cap. Soc. 250.000,00€ i.v. - R.E.A. di RE 175521
 Iscr.Reg.Impr. di RE n.01308390358 - N. Mecc. RE 010210
 C.F. e P.IVA IT 01308390358



4 Location of Items and connectors

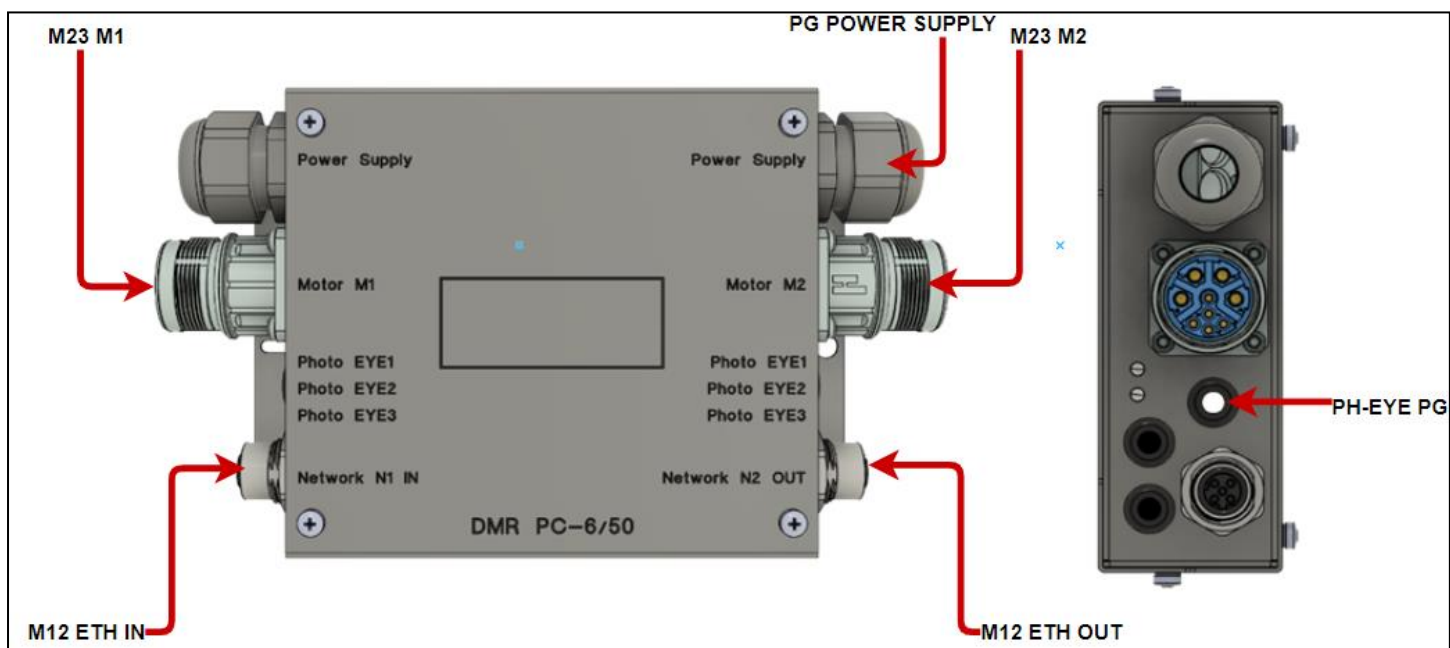

FIGURE 4-LOCATION OF ITEMS

To properly use the device the following items have to be identified:

Object	Description	Connector
Power Supply	Power Supply	PG13
Motor M1,M2	Motor Connector	M23 panel 9 pins
P1,P2,P3	Photo Eyes Connector Each Motor.	PG7
N1,N2	Network Connector	M12 d coded

Motor Power Company s.r.l.

Via Leonardo Da Vinci, 4
 42024 Castelnovo Sotto Reggio Emilia - Italia
 Tel. +39 0522 682710 - Fax +39 0522 683552
 info@motorpowerco.it - motorpowerco.com
 Cap. Soc. 250.000,00€ i.v. - R.E.A. di RE 175521
 Iscr.Reg.Impr. di RE n.01308390358 - N. Mecc. RE 010210
 C.F. e P.IVA IT 01308390358



5 Wiring

Open the box

To install the device and connect it to the power supply the external box have to be opened.

To do this operation a cross screwdriver is needed.

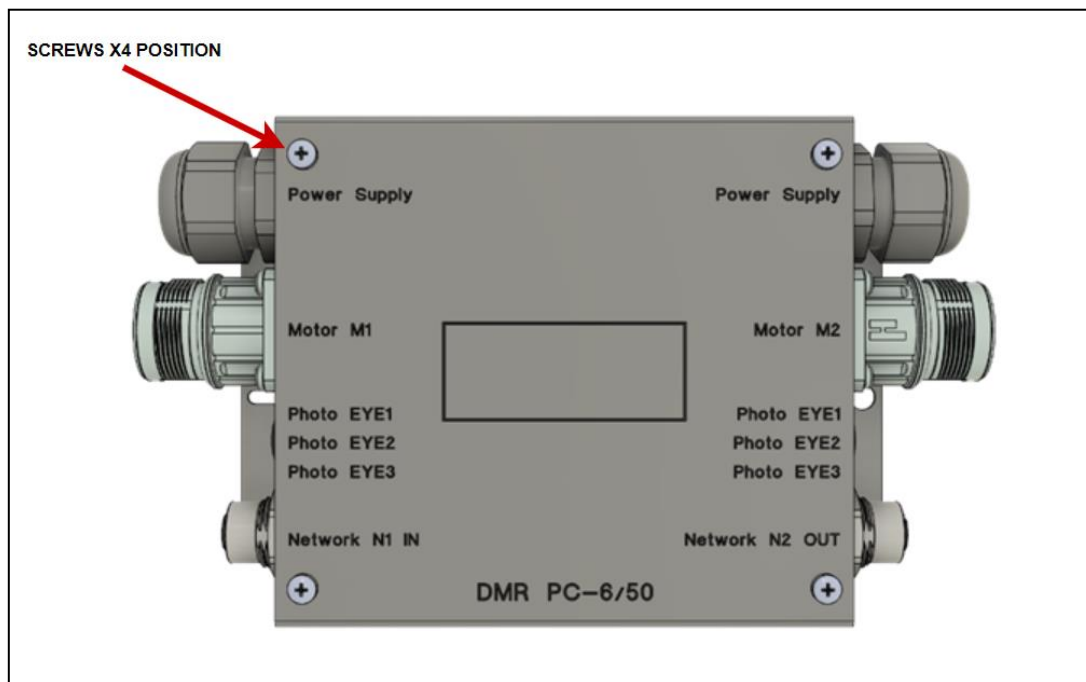

FIGURE 5-M3 SCREW POSITION

Four screws M3X4, in the 4 corners of the device need to be removed to open the box.



Only expert operator are allowed to open the device box. For your safety, Please open the box only when you are sure that power supply is off.

Motor Power Company s.r.l.

Via Leonardo Da Vinci, 4
42024 Castelnovo Sotto Reggio Emilia - Italia
Tel. +39 0522 682710 - Fax +39 0522 683552
info@motorpowerco.it - motorpowerco.com
Cap. Soc. 250.000,00€ i.v. - R.E.A. di RE 175521
Iscr.Reg.Impr. di RE n.01308390358 - N. Mecc. RE 010210
C.F. e P.IVA IT 01308390358

**MOTOR
POWER**
COMPANY

Power Supply PG – Power Supply internal connector

Externally we have a PG-13,5 cable Gland.

The internal connector type is **WAGO 745-503/006-000**

The recommended power wires are fine-stranded conductor 1-16 mm²

Pin	Function	Description
1	VP+	Power Supply 48Vdc
2	GND	0 Vdc
4	VL+	Logic Supply 24Vdc

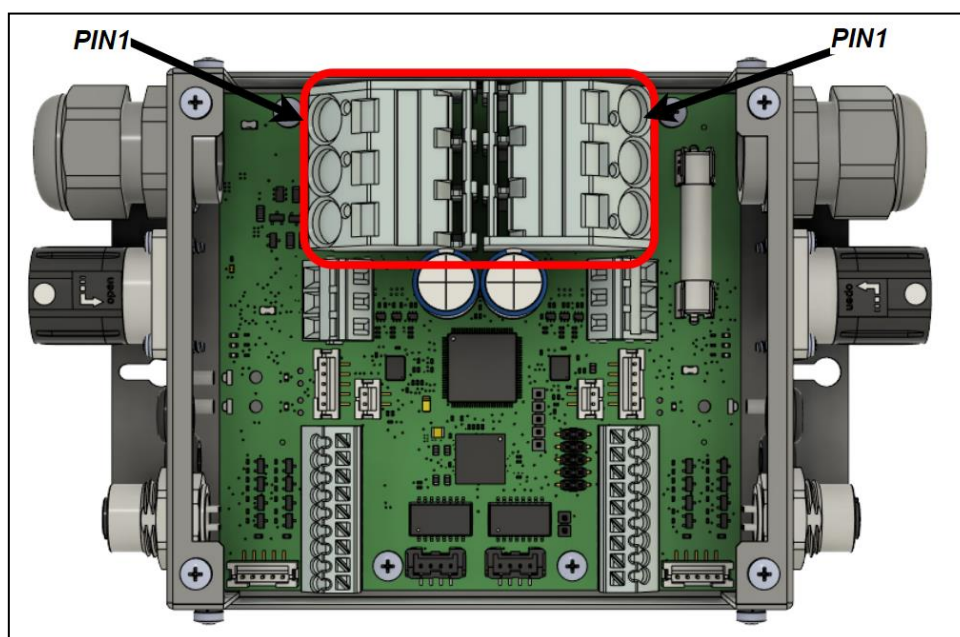

FIGURE 6: POWER SUPPLY CONNECTION

48 V dc switched-mode power supply, which can accept an overcurrent to handle the peak for 3 to 5s is recommended.

- The 24 Vdc Logic supply is protected with a 1 A fuse.
- The 48 Vdc Power supply is protected with a 20 A fuse.





Please provide a power supply that has enough power to in support the application.

Motor Power Company s.r.l.

Via Leonardo Da Vinci, 4
 42024 Castelnovo Sotto Reggio Emilia - Italia
 Tel. +39 0522 682710 - Fax +39 0522 683552
 info@motorpowerco.it - motorpowerco.com
 Cap. Soc. 250.000,00€ i.v. - R.E.A. di RE 175521
 Iscr.Reg.Impr. di RE n.01308390358 - N. Mecc. RE 010210
 C.F. e P.IVA IT 01308390358



	<p>Use Different power supply for Logic and Power. Motor Regeneration can damage the 24V Input Logic.</p>
---	---

	<p>To avoid Voltage Drop please use always the maximum allowed wire size.</p>
---	---

Connector M1, M2 – Motor Connector

The two possible drive motor connector are:

- **M23 9P MS 7556609010**
- **TE/Interconnect M15 PN is EDFA202NN00000501000**

M23 connector

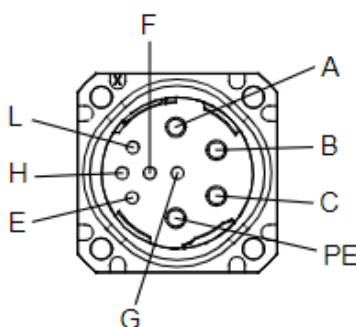

FIGURE 7-M23 CONNECOTR

Pin	Color	Function	Description
A	BL	Mu	Motor Phase
B	BR	Mv	Motor Phase
C	BK	Mw	Motor Phase
PE	GN/YE	Functional earth N.C.	Functional earth-N.C.
E	BN/GN	Feedback Power Supply	5 Vdc
F	WH/GN	Gnd	0 Vdc

G	GY	Hu	Hall Sensor u
H	PK	Hw	Hall Sensor w
L	YE	Hv	Hall Sensor v

M15 connector

Pin	Function	Description
1	Feedback Power Supply	5 Vdc
2	Gnd	0 Vdc
3	Hu	Hall Sensor u
4	Hv	Hall Sensor v
5	Hw	Hall Sensor w
A	Mu	Motor Phase
B	Mv	Motor Phase
C	Mw	Motor Phase
FE	Functional earth. N.C.	Functional earth-N.C.



Extension cables longer than 2 meters can cause voltage drops or distortions of the feedback signals. The device could not work properly.

Internal Connections

The motor connections have the following internal pinout

Motor Power Company s.r.l.

Via Leonardo Da Vinci, 4
42024 Castelnovo Sotto Reggio Emilia - Italia
Tel. +39 0522 682710 - Fax +39 0522 683552
info@motorpowerco.it - motorpowerco.com
Cap. Soc. 250.000,00€ i.v. - R.E.A. di RE 175521
Iscr.Reg.Impr. di RE n.01308390358 - N. Mecc. RE 010210
C.F. e P.IVA IT 01308390358

**MOTOR
POWER**
COMPANY

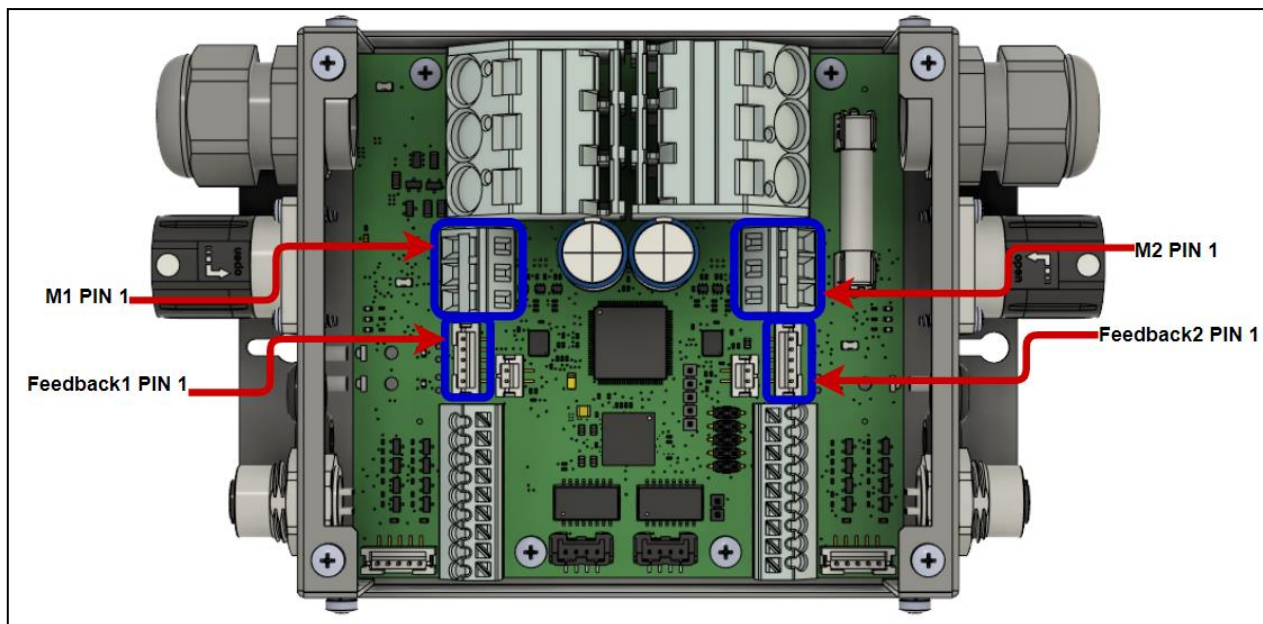

FIGURE 8: INTERNAL MOTOR CONNECTION LAYOUT

Internally the phases connector is a WAGO 236-403/000-012

Pin	Function	Description
1	Mw	Motor Phase w
2	Mv	Motor Phase v
3	Mu	Motor Phase u

The Hall sensors on a JST B5B-PH-SM4-TB(LF)(SN)

Pin	Function	Description
1	Hu	Hall sensor U
2	Hv	Hall sensor V
3	Hw	Hall sensor W
4	Feedback Power Supply	5 Vdc
5	Gnd	0 Vdc

The NTC (Optional) on a JST B2B-PH-SM4-TBT (LF)(SN)F

Pin	Function	Description
-----	----------	-------------

1	Feedback Power Supply	5 Vdc
2	NTC	Ntc Output

Photo Eye PG and Internal Connector

The internal connector is a WAGO 250-109.

The recommended wires are 0,5-1,5 mm²

Pin	Function	Description
1	Power Supply	24 V power supply
2	Photo Eye Input 1	Input signal
3	Gnd	0 Vdc
4	Power Supply	24 V power supply
5	Photo Eye Input 2	Input signal
6	Gnd	0 Vdc
7	Power Supply	24 V power supply
8	Photo Eye Input 3	Input signal
9	Gnd	0 Vdc

Photo Eyes have to be cabled in PG, 3 each axis.

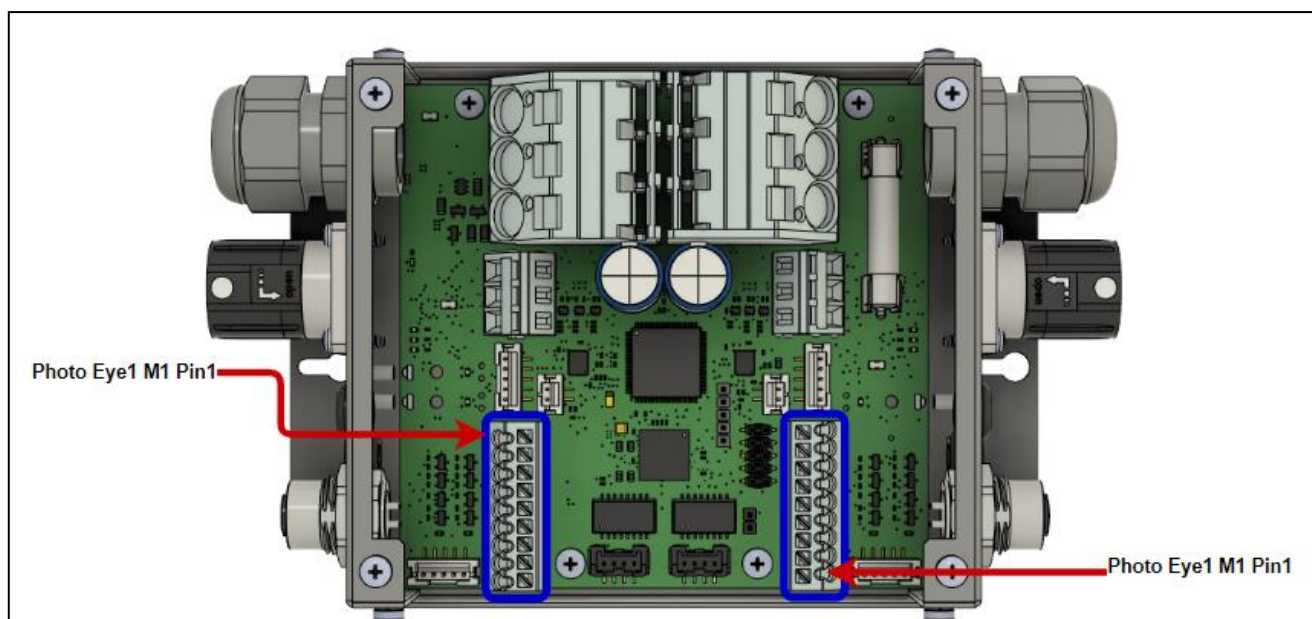

Motor Power Company s.r.l.
 Via Leonardo Da Vinci, 4
 42024 Castelnovo Sotto Reggio Emilia - Italia
 Tel. +39 0522 682710 - Fax +39 0522 683552
 info@motorpowerco.it - motorpowerco.com
 Cap. Soc. 250.000,00€ i.v. - R.E.A. di RE 175521
 Iscr.Reg.Impr. di RE n.01308390358 - N. Mecc. RE 010210
 C.F. e P.IVA IT 01308390358



FIGURE 9:PHOTO EYE CONNECTIONS

Photo Eye internal connection

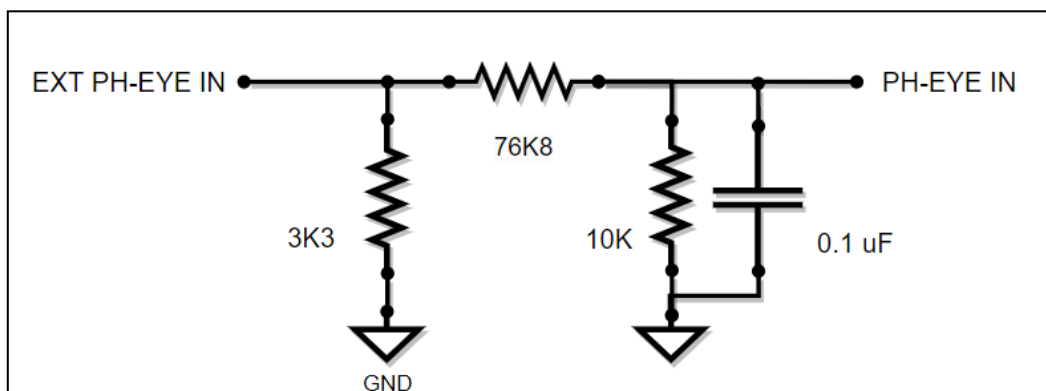

FIGURE 10

Internal I/O Connector (Optional)

The internal I/O connector is a JST B5B-PH-SM4-TBT (LF)(SN)F with the following functionality if the fieldbus is not enabled on the device.

Pin	Function	Description	Type
1	Error	Error on Motor	Digital Output
2	Out1	Out1	Digital Output
3	Enable	Enable the Motor	Digital Input
4	Dir	Direction of Motor	Digital Input
5	Speed	Velocity of the motor	Analog Input

Motor Power Company s.r.l.

Via Leonardo Da Vinci, 4
42024 Castelnovo Sotto Reggio Emilia - Italia
Tel. +39 0522 682710 - Fax +39 0522 683552
info@motorpowerco.it - motorpowerco.com
Cap. Soc. 250.000,00€ i.v. - R.E.A. di RE 175521
Iscr.Reg.Impr. di RE n.01308390358 - N. Mecc. RE 010210
C.F. e P.IVA IT 01308390358

**MOTOR
POWER**
COMPANY

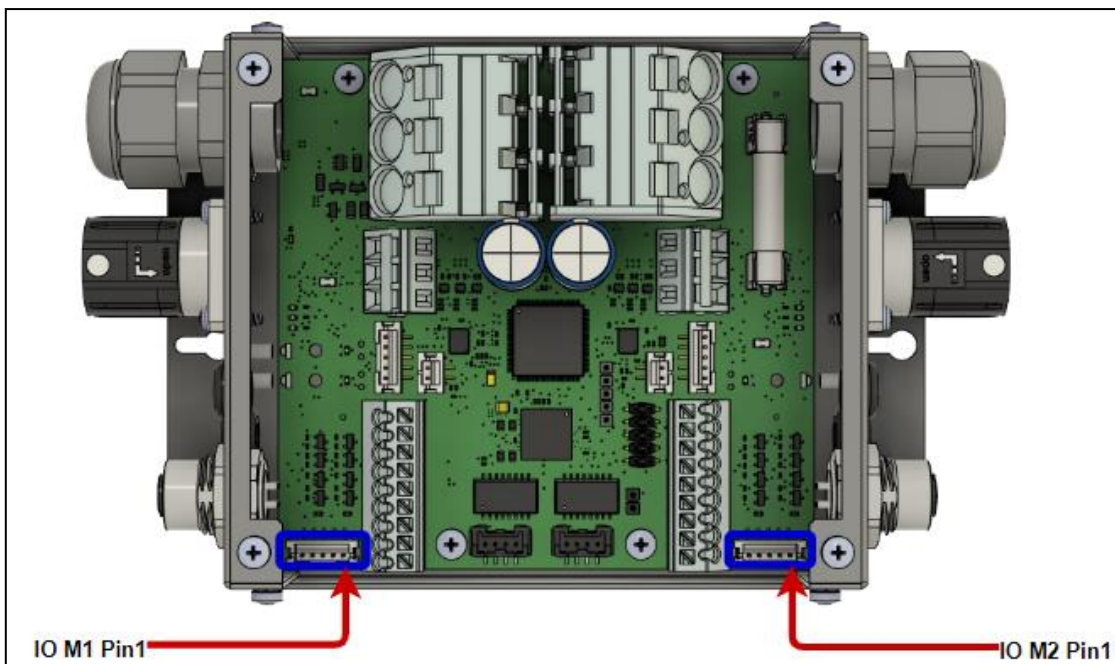

FIGURE 11 INTERNAL I/O CONNECTOR

Digital Input internal wiring

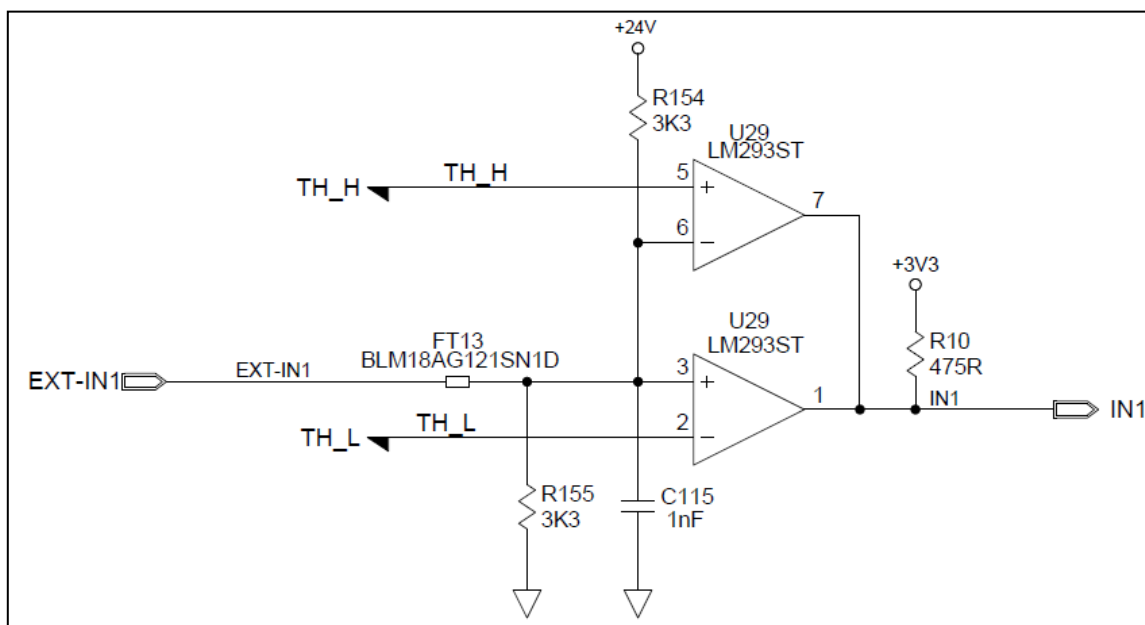

FIGURE 12

Typical input current @24Vcd is 7,2 mA. The input stage can accept both PNP and NPN input configuration.

Analog Input internal wiring

Note: VIN max is 30V

Motor Power Company s.r.l.
 Via Leonardo Da Vinci, 4
 42024 Castelnovo Sotto Reggio Emilia - Italia
 Tel. +39 0522 682710 - Fax +39 0522 683552
 info@motorpowerco.it - motorpowerco.com
 Cap. Soc. 250.000,00€ i.v. - R.E.A. di RE 175521
 Iscr.Reg.Impr. di RE n.01308390358 - N. Mecc. RE 010210
 C.F. e P.IVA IT 01308390358



The Analog Input can be used as 24V digital input if necessary.

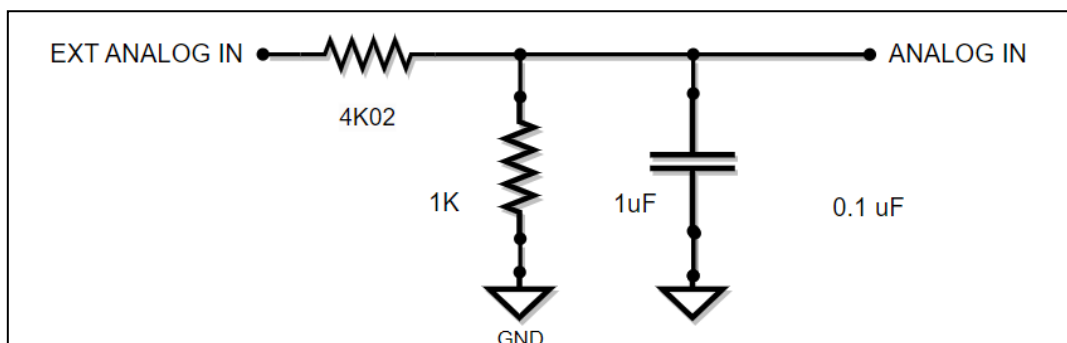

FIGURE 13

Digital Output Internal wiring

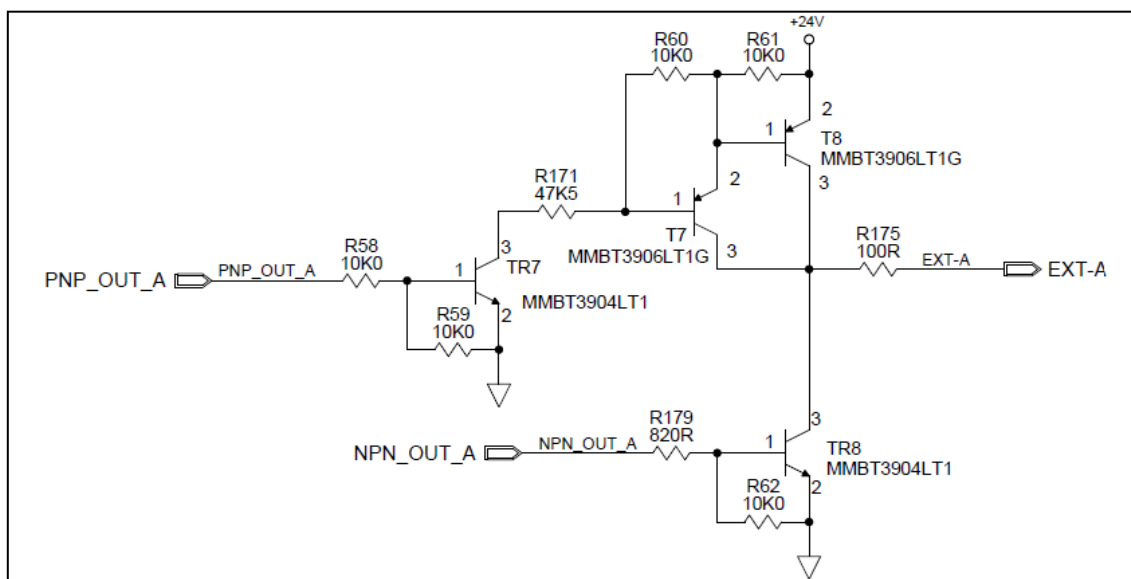



FIGURE 14

The output maximum current have to be $< 25 \text{ mA}$. To protect the output is suggested to add an external resistance $R > 860 \Omega$.

The output stage is configured to support only PNP configuration.

	<p>In the event of a current $\geq 25 \text{ mA}$, there is a risk to damage the output transistor.</p>
---	--

Connector N1,N2 - Network Connection

The Connector is M12 code d for ethernet communication.

Pin	Function	Description
1	TX+	Ethernet TX+
2	RX+	Ethernet RX+
3	TX-	Ethernet TX-
4	RX-	Ethernet RX-

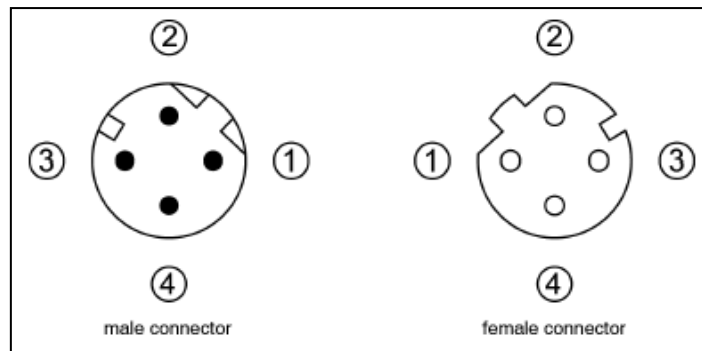

FIGURE 15: M12 ETHERNET PINOUT



Follow in and out configuration for a proper network functionality and topology.

Relation between a M12 and a RJ-45

Motor Power Company s.r.l.

Via Leonardo Da Vinci, 4
 42024 Castelnovo Sotto Reggio Emilia - Italia
 Tel. +39 0522 682710 - Fax +39 0522 683552
 info@motorpowerco.it - motorpowerco.com
 Cap. Soc. 250.000,00€ i.v. - R.E.A. di RE 175521
 Iscr.Reg.Impr. di RE n.01308390358 - N. Mecc. RE 010210
 C.F. e P.IVA IT 01308390358



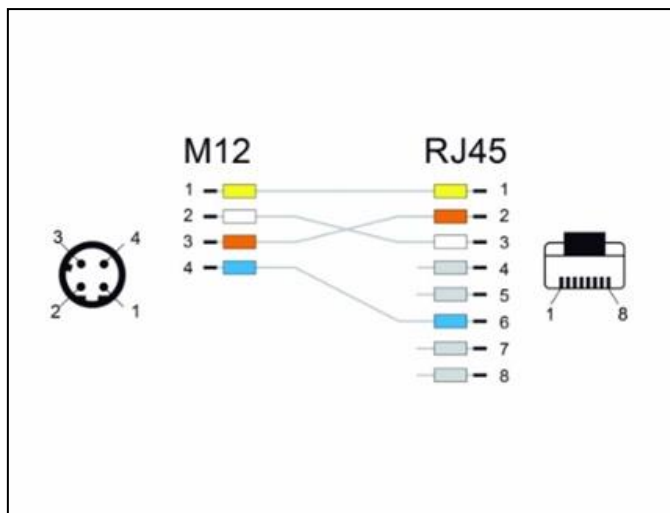

FIGURE 16

The internal connector is a **Molex 5055750-471**.

Pin	Function	Description
1	TX+	Ethernet TX+
2	TX-	Ethernet TX-
3	RX+	Ethernet RX+
4	RX-	Ethernet RX-

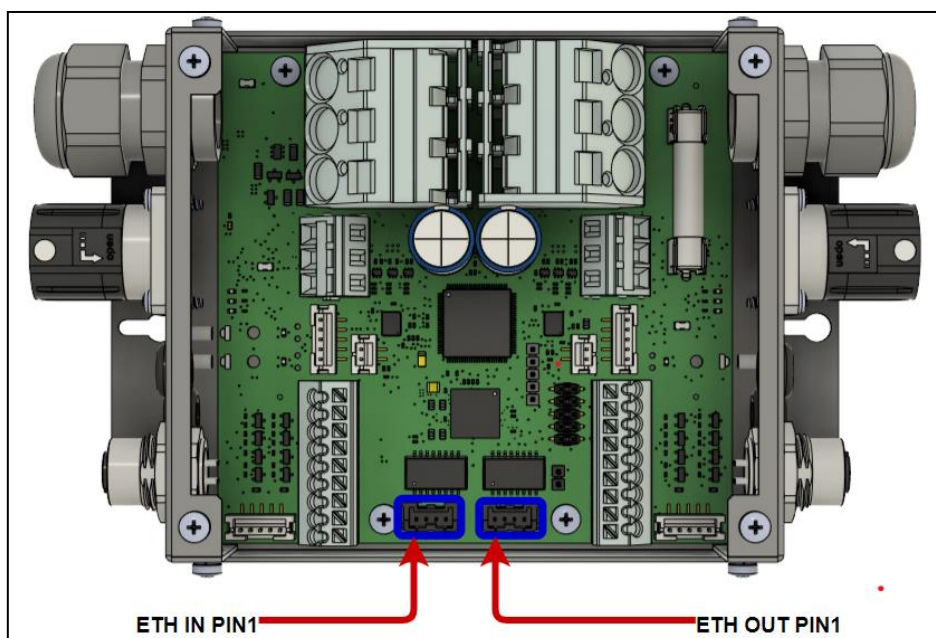

FIGURE 17: ETHERNET INTERNAL CONNECTION

Motor Power Company s.r.l.

Via Leonardo Da Vinci, 4
 42024 Castelnovo Sotto Reggio Emilia - Italia
 Tel. +39 0522 682710 - Fax +39 0522 683552
 info@motorpowerco.it - motorpowerco.com
 Cap. Soc. 250.000,00€ i.v. - R.E.A. di RE 175521
 Iscr.Reg.Impr. di RE n.01308390358 - N. Mecc. RE 010210
 C.F. e P.IVA IT 01308390358



Internal RS-485 connector (For Debug)

The device is equipped with an internal serial communication adapter for debug and local configuration purpose. The connector is a standard pin strip step 2,54 mm.

Pin	Function	Description
1	DATA+	RS 485
2	DATA-	RS 485

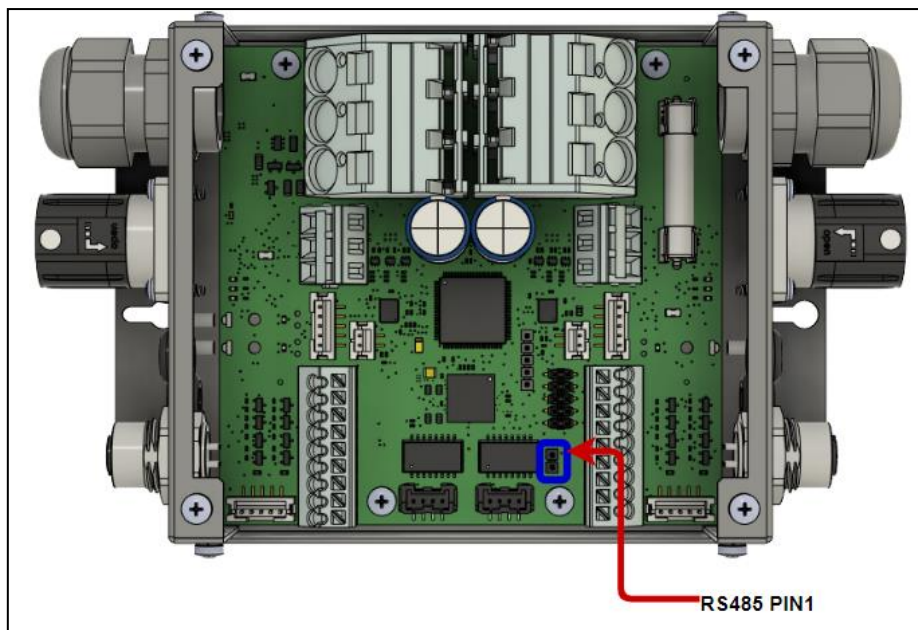



FIGURE 18: RS485 INTERNAL CONNECTION

Motor Power Company s.r.l.

Via Leonardo Da Vinci, 4
 42024 Castelnovo Sotto Reggio Emilia - Italia
 Tel. +39 0522 682710 - Fax +39 0522 683552
 info@motorpowerco.it - motorpowerco.com
 Cap. Soc. 250.000,00€ i.v. - R.E.A. di RE 175521
 Iscr.Reg.Impr. di RE n.01308390358 - N. Mecc. RE 010210
 C.F. e P.IVA IT 01308390358



6 Connection schematic

	<p>Warning: Before commissioning, it is essential that the safety instructions in the relevant section are read and understood, and then observed!</p> <p>Non-observance can result in danger to persons or damage to the equipment.</p> <ul style="list-style-type: none"> ▶ Disconnect the electrical power supply before any operation on the device.
	<p>CAUTION:</p> <p>Incorrect connection of motor power electronics. The motor is not equipped with reverse polarity protection.</p> <p>Consequence:</p> <p>Destroying of the power electronics possible.</p> <ul style="list-style-type: none"> ▶ Check the right polarity.
	<p>NOTICE: Loops must be avoided for all grounding concepts. Shielded cable must be used for the whole cable system without interruption. Up to a length of 10m a common power and signal cable can be used. If the cable is longer than 10m it is recommended to separate power and signal in different shielded cables. When standard wires from Motor Power Company are used, the shielding must be spaciouly applied inside the control cabinet.</p>

Failure to follow them can result in danger to persons or damage to the equipment.

Schematic circuit for power and logic supply

	<p>CAUTION: Peak current by switching-on of a variety of series-connected motors. Consequence: Destroying of the integrated electronics possible.</p> <p>► Using an adequate power supply.</p>
---	---

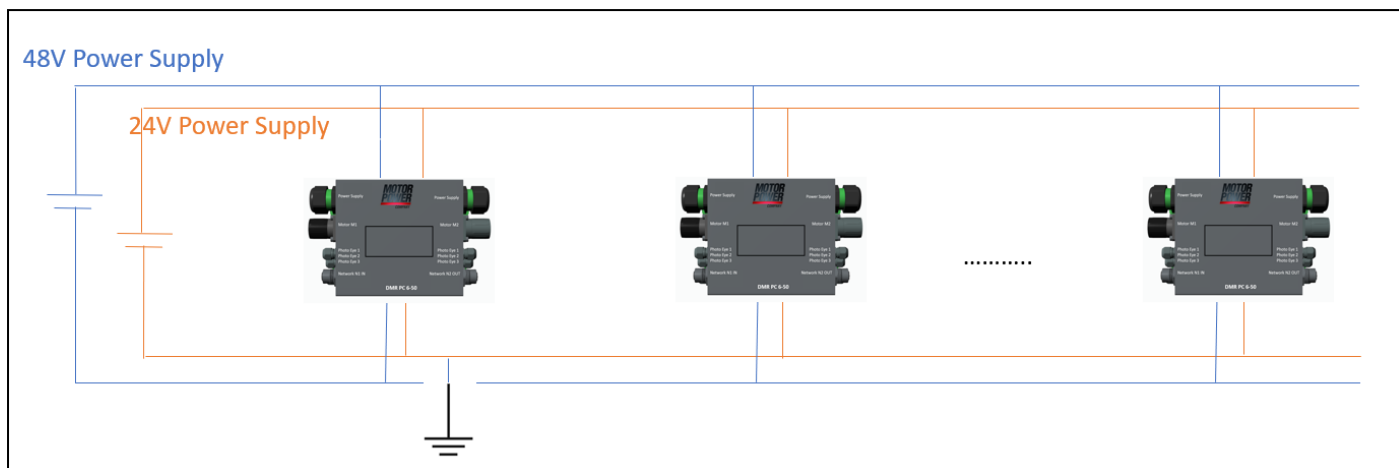

FIGURE 19: POWER SUPPLY SCHEMATIC

The number of devices you can daisy chain depends on the application, the wire size and the power supply. Please contact our support to correctly size your plant.

A typical power and logic supply cabling is shown below:

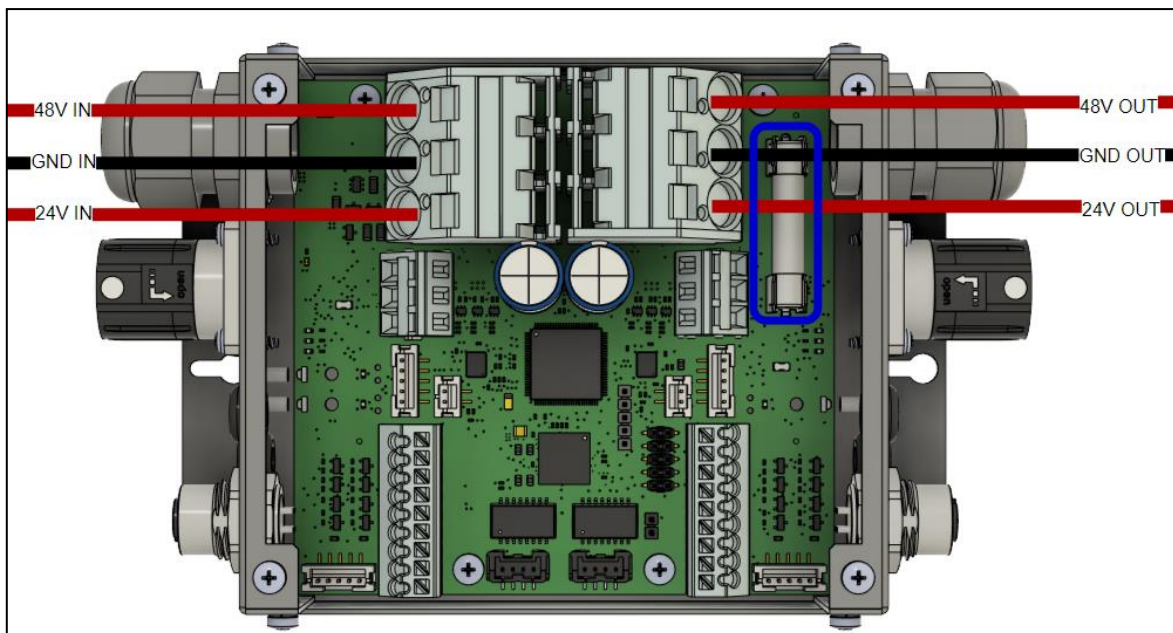

FIGURE 20 POWER SUPPLY CABLING, IN BLUE THE 20A FUSE ON VP

7 Default I/O Functionality (Optional)

Run/Stop

This is the signal to use to enable/disable the Device. Please consider that for encoder version 1s delay have to be considered at the first startup, to allow the current phase identification.

Once the Device is enabled this will follow immediately the V-IN setpoint.

DIR – Direction of Rotation

The default Direction of rotation is clock wise Motor A Flange if the DIR pin is set to Low.



V-IN – Speed Variation

Speed variation by an external analogue voltage from 0 to 10Vdc.

All the voltage above 10Vdc will be clamped to the 10Vdc value.

The default gains is applied 10 Vdc -> 800 rpm, and also the speed profiled is enable limiting the acceleration to 0,4 g (considering a roller diameter of 50 mm)



Be careful to not exceed the 24Vdc to not damage the analogue input.



Connect all the 0 VDC points of the external analogue power supply to the 0 Vdc of the Power connector

Motor Power Company s.r.l.

Via Leonardo Da Vinci, 4
42024 Castelnovo Sotto Reggio Emilia - Italia
Tel. +39 0522 682710 - Fax +39 0522 683552
info@motorpowerco.it - motorpowerco.com
Cap. Soc. 250.000,00€ i.v. - R.E.A. di RE 175521
Iscr.Reg.Impr. di RE n.01308390358 - N. Mecc. RE 010210
C.F. e P.IVA IT 01308390358

**MOTOR
POWER**
COMPANY

ERR – Error Signal

The signal is High when no error is present and Low when we have an error condition.



When powering on and off, the error signal could be set. Do not consider this signal during 0.5s to power on, and 2s to power off.

Customized I/O configuration

It's possible using the Modbus RTU protocol and the Standard GUI to modify the digital input and output capability and logic levels of all the I/O present on the device. Please refer to the Software Manual to explore all the possible options.

Motor Power Company s.r.l.

Via Leonardo Da Vinci, 4
42024 Castelnovo Sotto Reggio Emilia - Italia
Tel. +39 0522 682710 - Fax +39 0522 683552
info@motorpowerco.it - motorpowerco.com
Cap. Soc. 250.000,00€ i.v. - R.E.A. di RE 175521
Iscr.Reg.Impr. di RE n.01308390358 - N. Mecc. RE 010210
C.F. e P.IVA IT 01308390358

**MOTOR
POWER**
COMPANY

8 LED Configuration

On the Device 7 LED are present, not all are used. Here below you can find the position and the functions related to each one.

LED Map

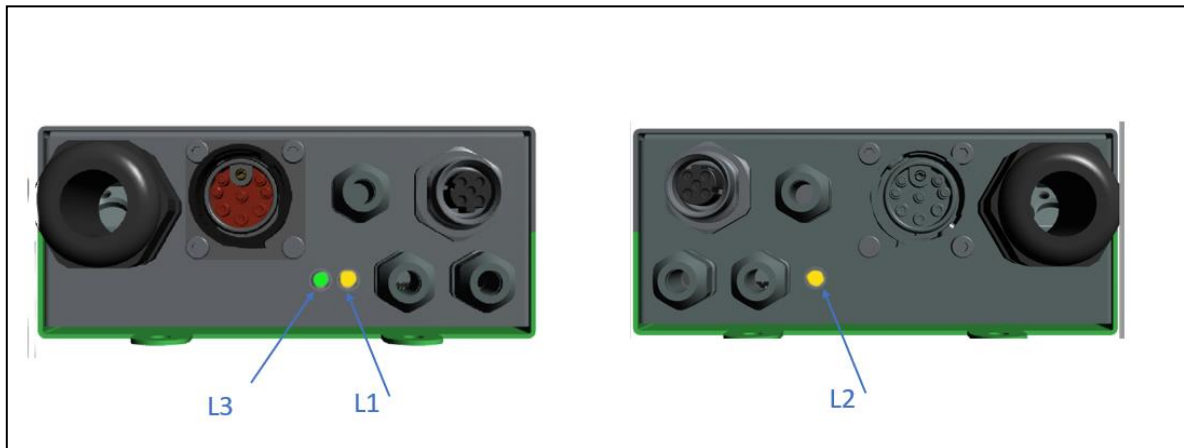

FIGURE 21-LEDs POSITION

LED	Color	Function	Note
L1	Yellow	Axis M1 Status	
L2	Yellow	Axis M2 Status	
L3	Green	Power Supply Status	

Motor Power Company s.r.l.

Via Leonardo Da Vinci, 4
 42024 Castelnovo Sotto Reggio Emilia - Italia
 Tel. +39 0522 682710 - Fax +39 0522 683552
 info@motorpowerco.it - motorpowerco.com
 Cap. Soc. 250.000,00€ i.v. - R.E.A. di RE 175521
 Iscr.Reg.Impr. di RE n.01308390358 - N. Mecc. RE 010210
 C.F. e P.IVA IT 01308390358



L1 and L2 Axis Status

The LED L1 and L2 show the axis status.

STATUS	DESCRIPTION
Blinking Fast	Axis OK and Disabled
Solid Green	Axis Enabled
Off	Axis Fault

L3 Auxiliary Power Supply Status

The LED L3 show the Auxiliary Power Supply Status.

STATUS	DESCRIPTION
Solid Green	Auxiliary Power Supply Ok
Off	No Logic Power Supply – Device Off

Motor Power Company s.r.l.

Via Leonardo Da Vinci, 4
42024 Castelnovo Sotto Reggio Emilia - Italia
Tel. +39 0522 682710 - Fax +39 0522 683552
info@motorpowerco.it - motorpowerco.com
Cap. Soc. 250.000,00€ i.v. - R.E.A. di RE 175521
Iscr.Reg.Impr. di RE n.01308390358 - N. Mecc. RE 010210
C.F. e P.IVA IT 01308390358



Internal LED

The device is equipped internally of 6 led for Photo eye input, each led show the status of the input and can provide immediate debug for the photo eye maintenance. The leds are visible only if the device is open.



Only expert operator are allowed to open the device box. For your safety, Please open the box only when you are sure that power supply is off.

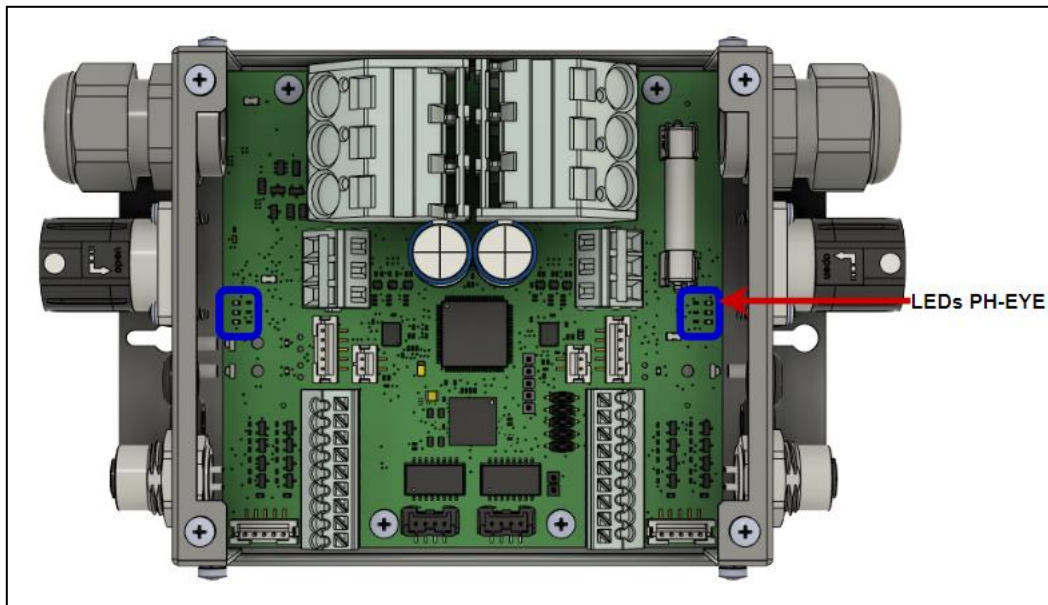

FIGURE 22: INTERNAL LED POSITION

Motor Power Company s.r.l.

Via Leonardo Da Vinci, 4
42024 Castelnovo Sotto Reggio Emilia - Italia
Tel. +39 0522 682710 - Fax +39 0522 683552
info@motorpowerco.it - motorpowerco.com
Cap. Soc. 250.000,00€ i.v. - R.E.A. di RE 175521
Iscr.Reg.Impr. di RE n.01308390358 - N. Mecc. RE 010210
C.F. e P.IVA IT 01308390358



9 Information on the motor

Motor Phase Angle

For a correct operation, the motor must have a correct electrical configuration.

Specification	Value
Speed	1000 rpm
Direction	Clockwise (A Motor Flange/Cable Side)
Reference Voltage	Concatenate
Tolerance	+/- 20 Electrical degrees

The electrical configuration must follow this schema:

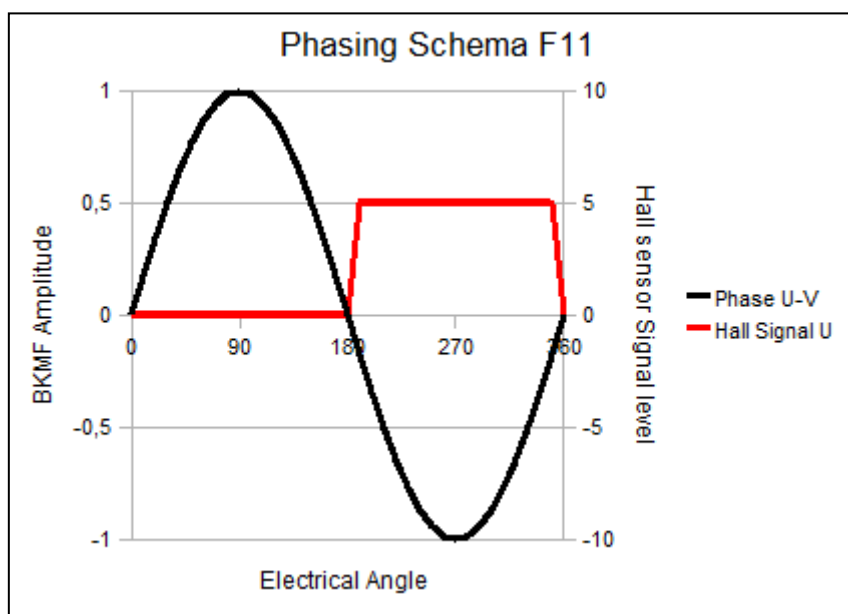
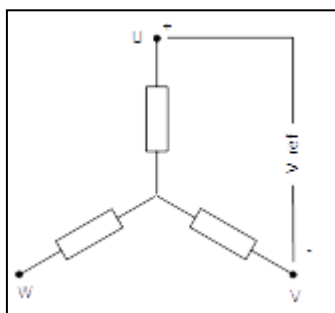

FIGURE 23

Every hall signal must be referred to the proper reference voltage:



Reference Voltage	Hall Signal Value
U-V	Hall Signal U
V-W	Hall Signal V
W-U	Hall Signal W

Hall signal sequence

Hall sensor follow a grey code sequence. Rotating the motor Clockwise (front flange) we must find this configuration.

Value	Hall U	Hall V	Hall W
1	0	0	1
3	0	1	1
2	0	1	0
6	1	1	0
4	1	0	0
5	1	0	1

Motor Power Company s.r.l.

Via Leonardo Da Vinci, 4
42024 Castelnovo Sotto Reggio Emilia - Italia
Tel. +39 0522 682710 - Fax +39 0522 683552
info@motorpowerco.it - motorpowerco.com
Cap. Soc. 250.000,00€ i.v. - R.E.A. di RE 175521
Iscr.Reg.Impr. di RE n.01308390358 - N. Mecc. RE 010210
C.F. e P.IVA IT 01308390358



Motor Phase Sequence

Rotating clock-wise from motor A flange

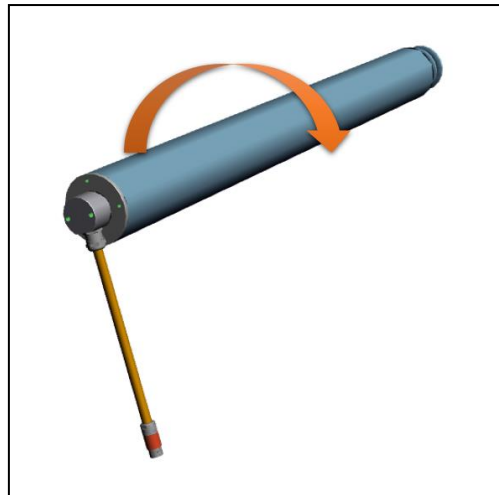

FIGURE 24: MOTOR DIRECTION

this is the correct phase sequence

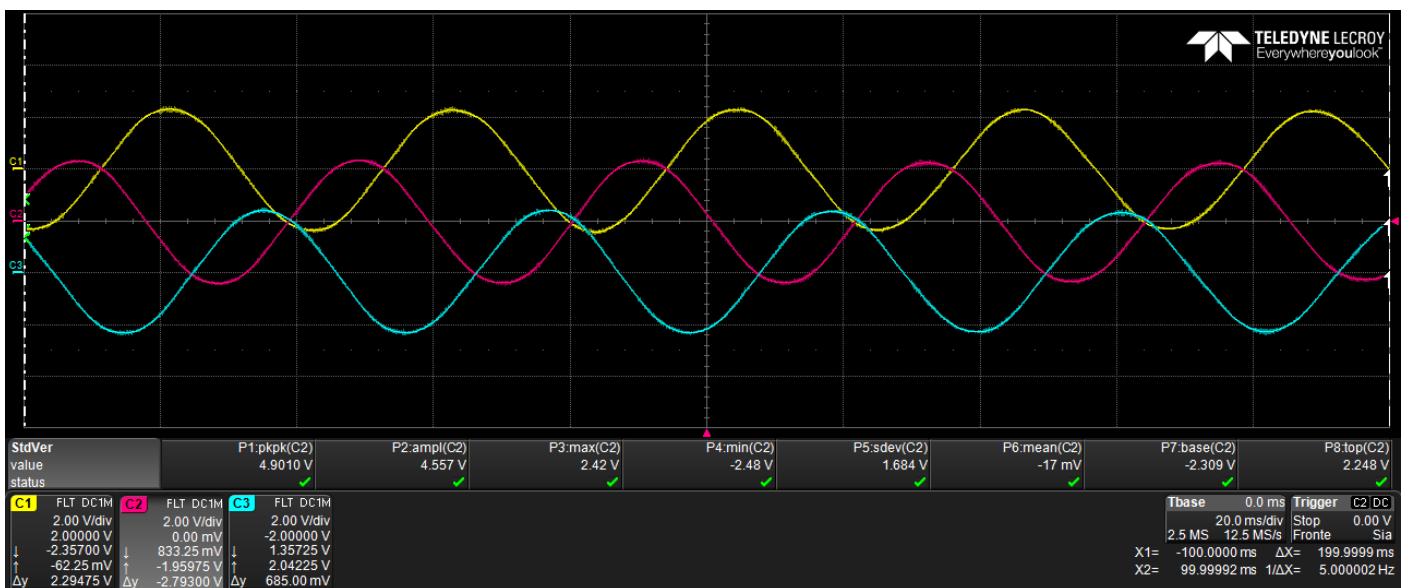

IMAGE 1

Where:

C1 = Phase U, C2 = Phase V, C3 = Phase W

Motor Power Company s.r.l.

Via Leonardo Da Vinci, 4
 42024 Castelnovo Sotto Reggio Emilia - Italia
 Tel. +39 0522 682710 - Fax +39 0522 683552
 info@motorpowerco.it - motorpowerco.com
 Cap. Soc. 250.000,00€ i.v. - R.E.A. di RE 175521
 Iscr.Reg.Impr. di RE n.01308390358 - N. Mecc. RE 010210
 C.F. e P.IVA IT 01308390358



10 Standard Configuration Interface

Setup for Modbus RTU

In order to connect with the device with RS485 serial communication you need:

- **005016000175** INTERFACE CONVERTER PC USB/485 USB2-H-5001-M
- **003016000669** COMMUNICATION SERIAL CABLE RS485
- UI installed from www.motorpowerco.it

Our standard USB to RS485 converter is **USB2-H-5001-M** that can be found on any major distributor web site, or you can buy form Motor Power Company . Any other converter with same capability can be used.

Below the correct dip-switch configuration.

- ECHO-OFF
- RS485 Terminator-ON



FIGURE 25: USB ADAPTER DIP SWITCH



If the dip-switch will not have the proper configuration you will not be able to communicate with the device.

Then connect the communication serial cable to the DMR PC as below.

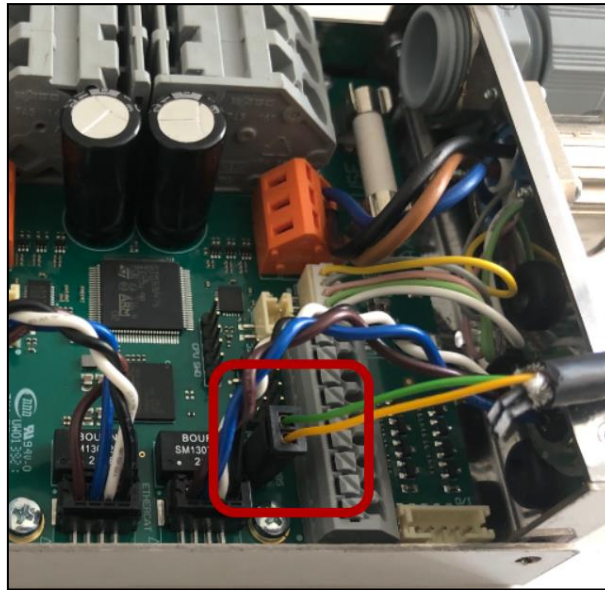

FIGURE 26-COM CABLE CONNECTION

With standard RJ-45 cables this is the correct color sequence:

Serial Cable	USB adapter PIN
D+(Green)	Pin2
D-(Yellow)	Pin1

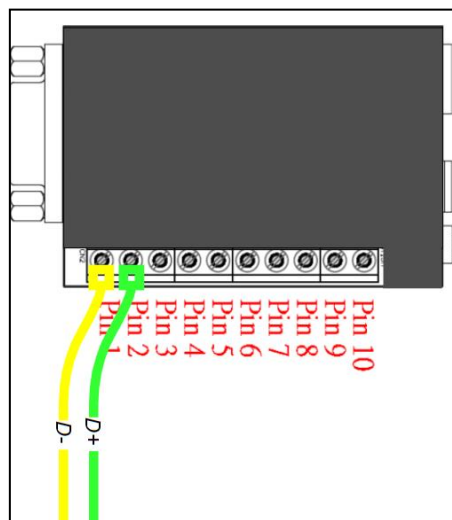

FIGURE 27: RS485 WIRE CONNECTION

Standard communication parameters

The standard configuration for the Modbus RTU communication is:

Data	Value
Baud Rate	460.800
Data Bit	8
Stop Bit	1
Parity	No
Default Node	247

Connecting to the UI

To connect to UI first check:

- USB converter is properly configured and connected
- DMR PC is connected to converter via serial to USB converter cable
- DMR PC is switched on
- UI is installed
- Standard communication parameters are consistent with previous table

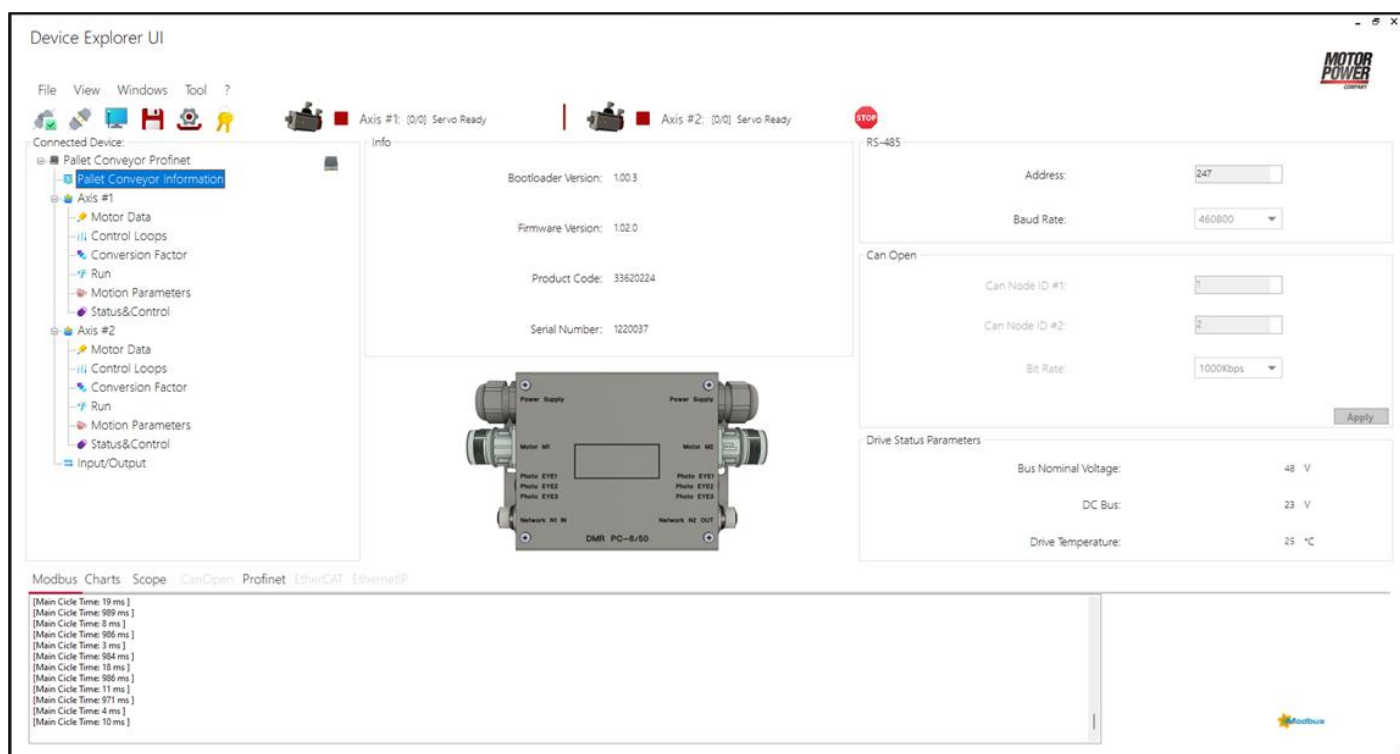

FIGURE 28-DMR PC IS CONNECTED VIA UI

UI basic operations

FW Upgrade

Firmware upgrade via RS485 is possible with user interface:

- Select Tools/FW upgrade/Modbus
- Select the FW.bin file to download
- Check the COM PORT
- Set the device in bootloader mode
- Start FW upgrade

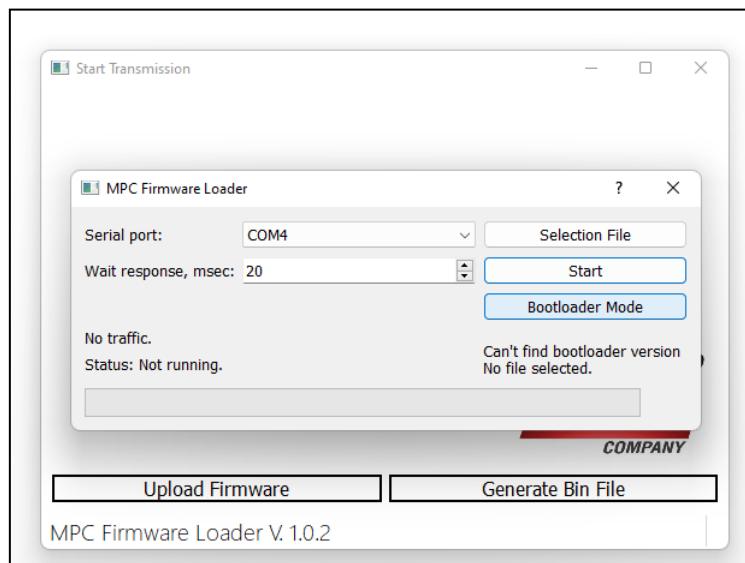

FIGURE 29-FW UPLOAD TOOL

Parameters storing/saving

With the Save Parameters Tools is possible to:

- Save data to permanent memory (EEPROM)
- Load parameters from file
- Save parameters to file

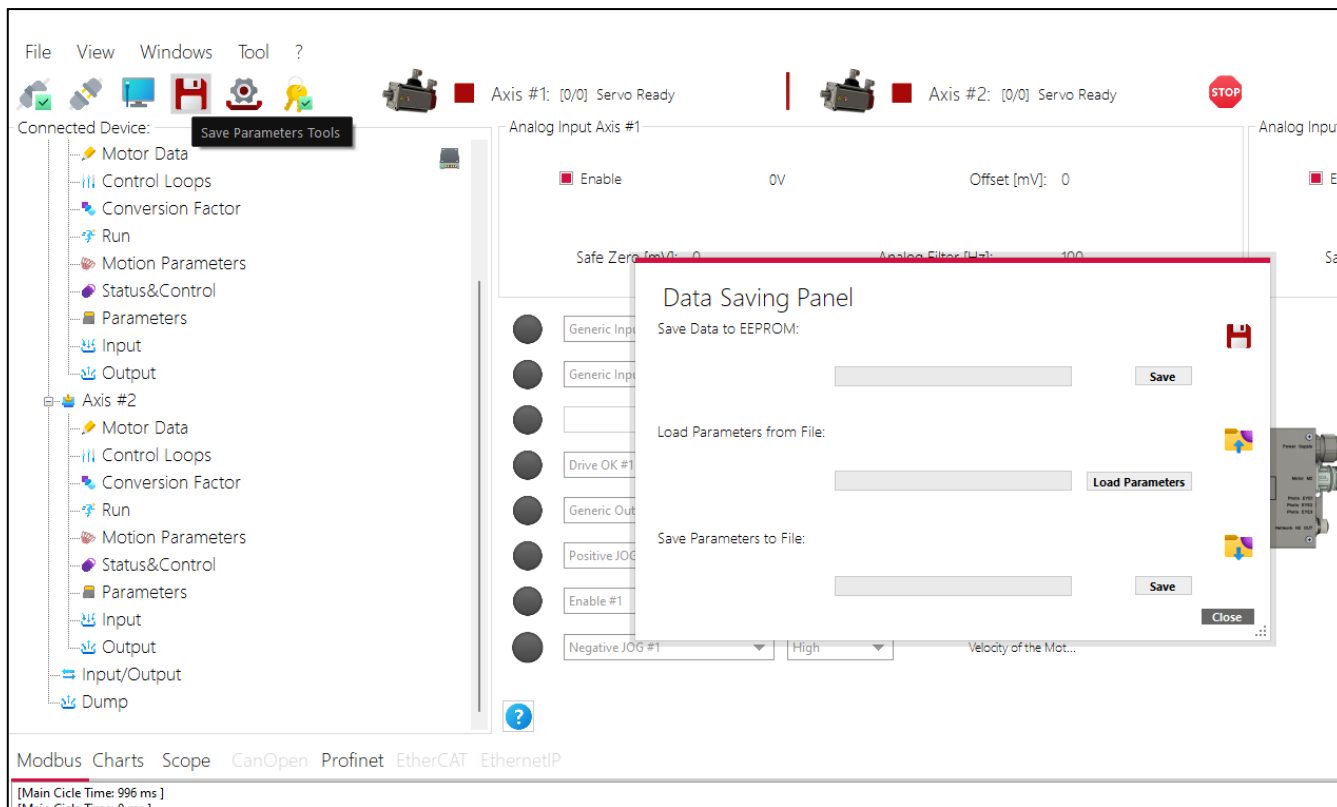

FIGURE 30-DATA SAVING PANEL

IOs configuration

It is possible to use the DMR with IOs too, in order to configure the desired functions to associate use the Input/Output Tab.

The service and commissioning software UI interface permits comprehensive parameter settings for the the drive, followed by work in standalone operation.

	<p>Note: if the device is controlled by fieldbus some functions and IO features may not be working properly</p>
--	---

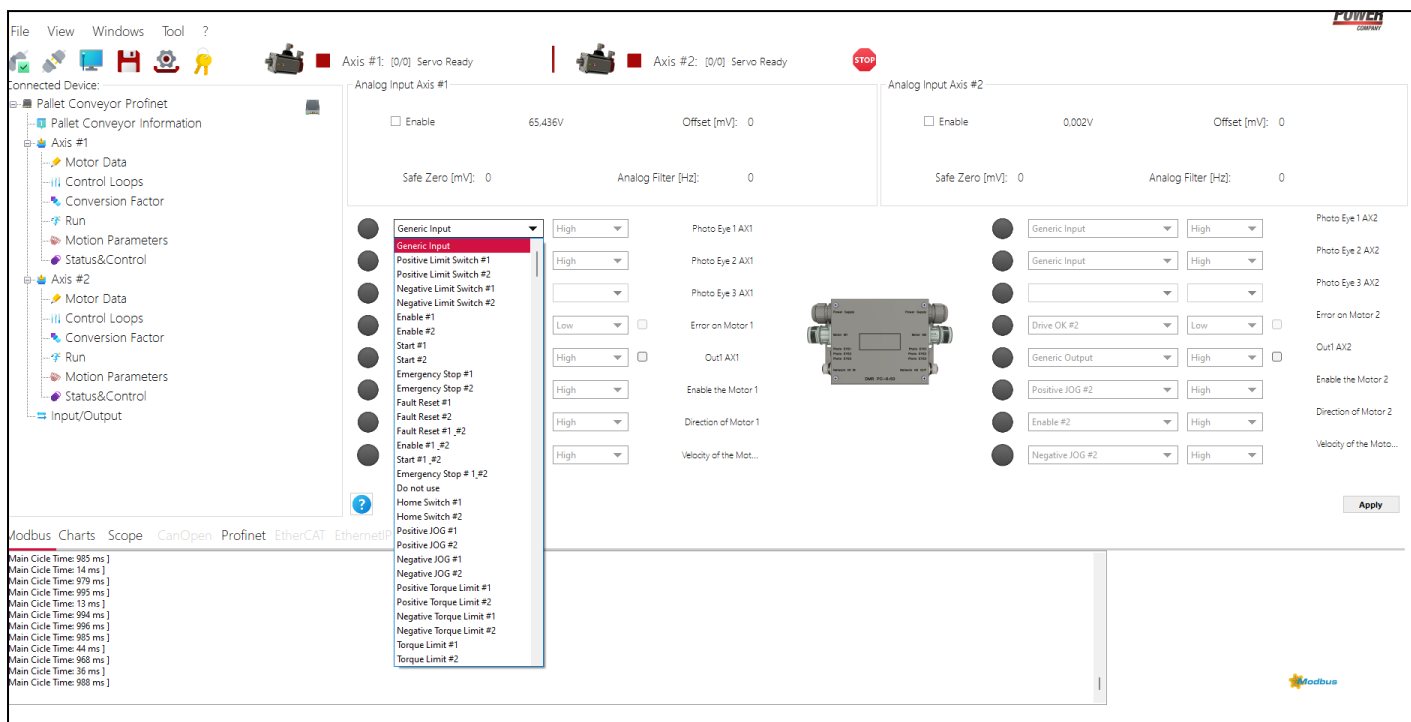

FIGURE 31-IO TAB

In standard configuration, no functions are associated to any input.

The following functions are possible for both axes, among other things:

Input Function	DESCRIPTION
Positive Limit Switch	homing function DS402
Negative Limit Switch	homing function DS402
Enable	Standard function IN0
Emergency Stop	it stop the motor as halt
Fault Reset	reset faults on rising edge
Home Switch	homing function DS402
Positive JOG	jog at jot vel
Negative JOG	jog at jot vel
Positive Torque Limit	Limit the torque of the motor in positive dir
Negative Torque Limit	Limit the torque of the motor in positive dir

Torque Limit	Limit the torque of the motor in both dir
Analog Input Polarity	Standard function IN1
Enable and Dir CW	enable and rotate at pos dir
Enable and Dir CCW	enable and rotate at neg dir

Regarding digital output these functions are possible for both axes, among other things:

Input Function	DESCRIPTION
Fault	FAULT PROTECTION FUNCTION
In Position	TARGET POSITION REACHED
Drive Homed	Homing function ATTAINED

To run the motor in velocity mode with IOs:

- Set **ENABLE** function to desired Input or Photo Eye
- Set **Analog Input Polarity** function to desired Input or Photo Eye
- Activate **Analog Input** to desired Axis

To activate analog input select the checkbox as below.

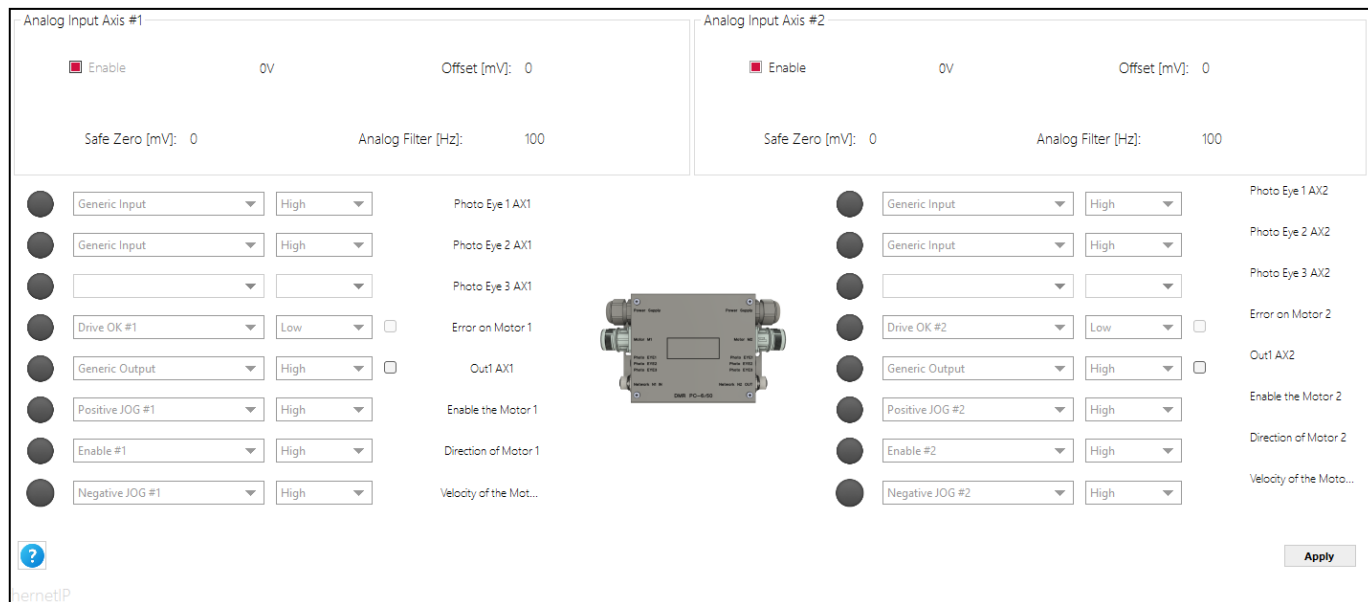

FIGURE 32-ACTIVATE ANALOG INPUT

Once activated the target velocity value is given by the AIN differential value (0 to 10VDC) and can be calculated as follow:

Motor Power Company s.r.l.
 Via Leonardo Da Vinci, 4
 42024 Castelnovo Sotto Reggio Emilia - Italia
 Tel. +39 0522 682710 - Fax +39 0522 683552
 info@motorpowerco.it - motorpowerco.com
 Cap. Soc. 250.000,00€ i.v. - R.E.A. di RE 175521
 Iscr.Reg.Impr. di RE n.01308390358 - N. Mecc. RE 010210
 C.F. e P.IVA IT 01308390358



$$Velocity\ Target = \frac{Max\ Motor\ Speed * AIN(mV)}{10000\ mV}$$

Where:

- Max motor speed is the maximum speed that motor can reach; to change this value use the UI interface.
- AIN is the value of the input with respect to board GND from 0 to 10V
- Velocity Target is the corresponding velocity command obtained with AIN value. Velocity Target will follow the polarity of the Analog Input Polarity function if present to determine the rotation direction

	<p>NOTE: A not connected analogue input equals 0 rpm velocity.</p> <p>Set the proper offset if a drift from zero with no signal is present.</p>
---	---

Set value voltages over +10V are allowed, but do not effect any increase of motor speed.

Conversion Factors

The conversion factors tab allow the user to change the user units to use.

Please refer to UI manual for more information.

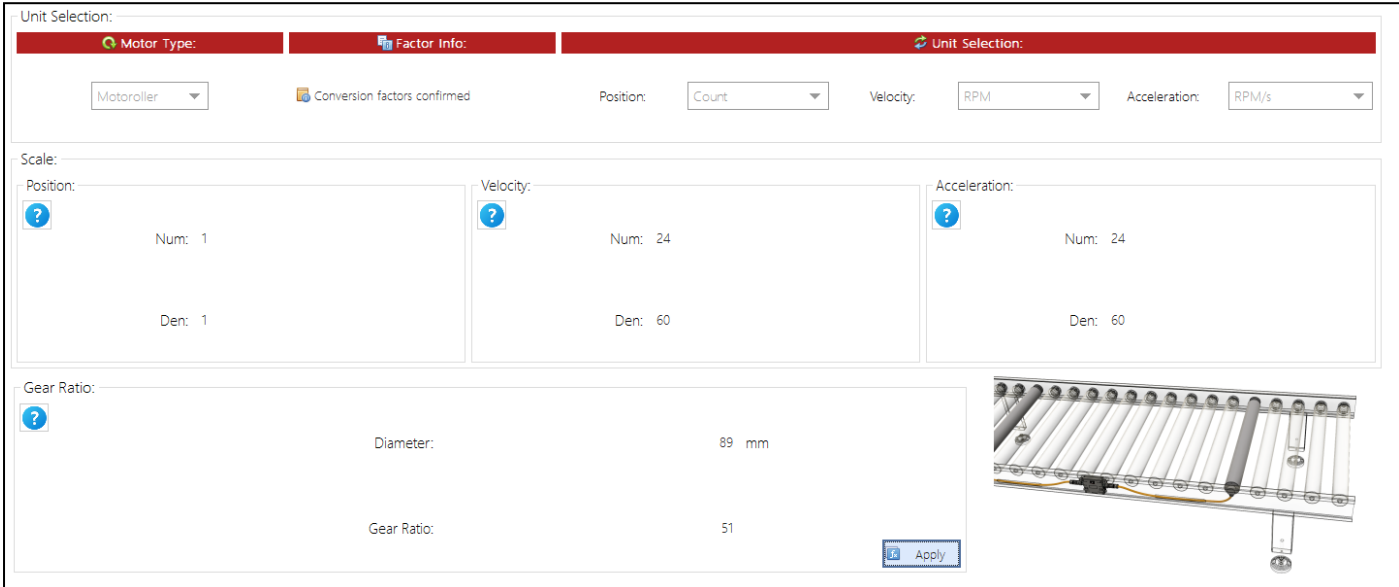

FIGURE 33-CONVERSION FACTORS TAB

11 Protective Functions

Undervoltage Switch-Off of the Power-

If the supply voltage drops below the threshold set in the parameters, the power stage will switch off. The failure can be acknowledged via the communication interface if the power voltage that can be read via the communication interface is under the threshold.

Overvoltage Switch-Off of the Power-

If the supply voltage rise above the threshold set in the parameters, the power stage will switch off. The failure can be acknowledged via the communication interface if the power voltage that can be read via the communication interface is under the threshold.

Overtemperature Protection

To protect the motor at overload, a temperature sensor is integrated in the electronic output stage to measure the PCB temperature and switch off the controller if the temperature is too high. The failure must be acknowledged in order to take the drive unit back into operation after deactivation.

Current limitation

The motor is protected from thermal overload by an I^2t based algorithm. It calculates the heat supply caused by the phase current and limits the nominal current if the calculated motor temperature exceeds the critical threshold. This protection mechanism permits overloading of the motor for a defined period without any risk of thermal damage to the motor winding or the electronics. When the critical threshold is reached, the nominal current is limited to the conditions current. Once the estimated temperature drops below the hysteresis, the nominal current is no longer limited at the maximum current is permitted again. (The maximum current can be limited by other current limitations: Static current limitation and I^*). The calculated temperature drops when the nominal current is less than the continuous current.

The Overload Protection is configurable via UI interface, once the I^2t algorithm overtakes the maximum motor load value (100%) a specific parameter can define if an error will be generate (motor rated current error) or it will limit maximum current of drive to the nominal value of the current to protect both motor and electronics.

It depends on the type of motor, the starting temperature and the overcurrent. The resulting duration for an operating point may be determined via the enclosed figures.

NOTE: The I^2t -algorithm loses information when the logic supply is switched off. In certain situations, this may cause severe thermal damage to the motor.

Motor Power Company s.r.l.

Via Leonardo Da Vinci, 4
42024 Castelnovo Sotto Reggio Emilia - Italia
Tel. +39 0522 682710 - Fax +39 0522 683552
info@motorpowerco.it - motorpowerco.com
Cap. Soc. 250.000,00€ i.v. - R.E.A. di RE 175521
Iscr.Reg.Impr. di RE n.01308390358 - N. Mecc. RE 010210
C.F. e P.IVA IT 01308390358



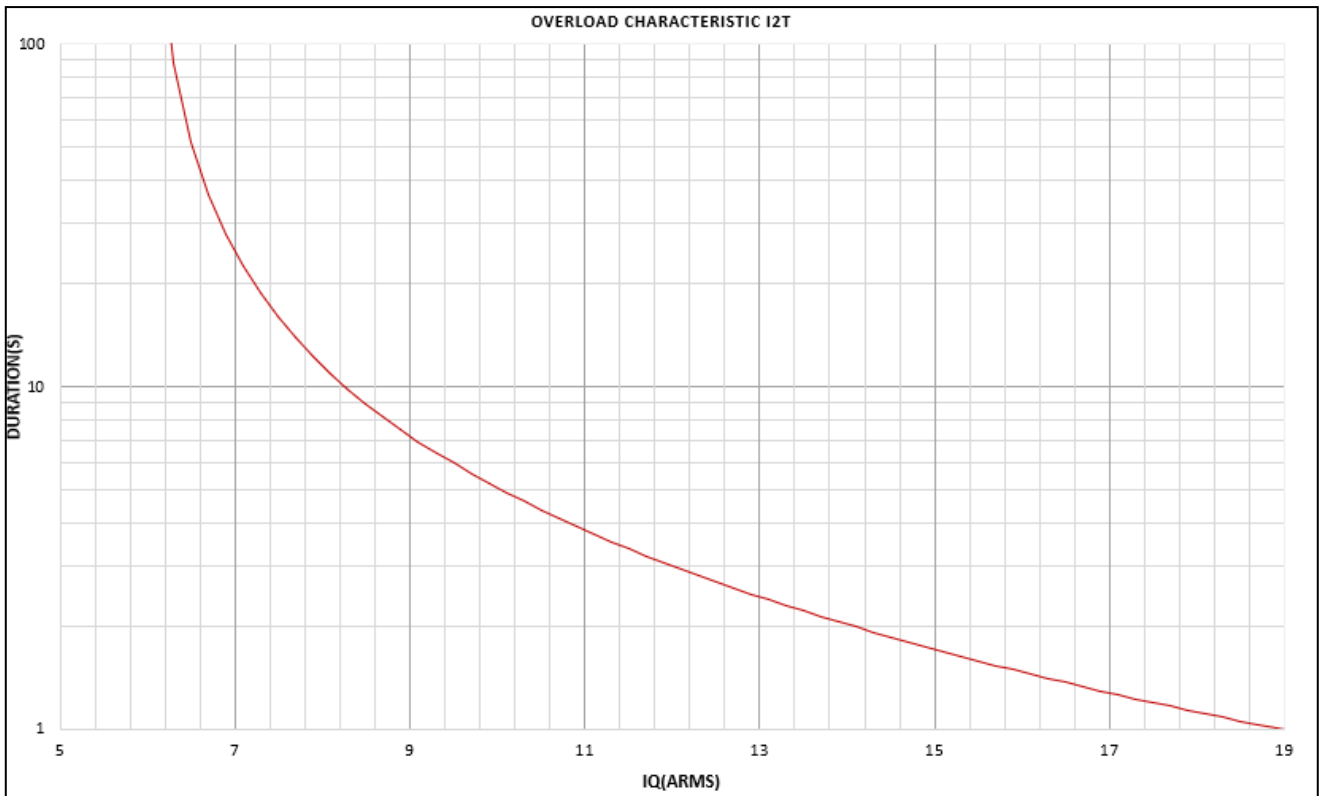

FIGURE 34-I2T CHARACTERISTIC FOR DMR PC WITH MTR 89 AT 40°C

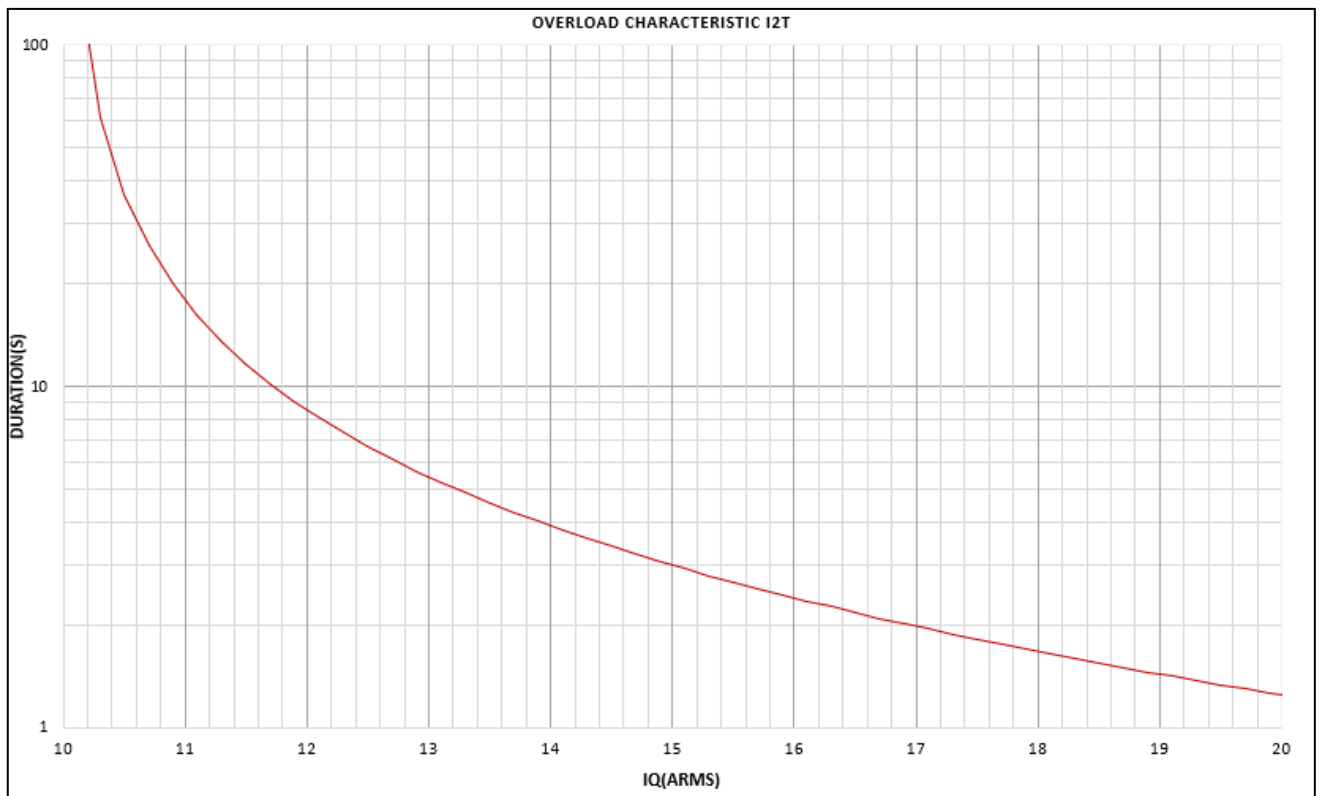

FIGURE 35- I2T CHARACTERISTIC FOR DMR PC WITH MTR 70 AT 40°C

Motor Power Company s.r.l.
 Via Leonardo Da Vinci, 4
 42024 Castelnovo Sotto Reggio Emilia - Italia
 Tel. +39 0522 682710 - Fax +39 0522 683552
 info@motorpowerco.it - motorpowerco.com
 Cap. Soc. 250.000,00€ i.v. - R.E.A. di RE 175521
 Iscr.Reg.Impr. di RE n.01308390358 - N. Mecc. RE 010210
 C.F. e P.IVA IT 01308390358



Fuses

The DMR PC is protected with

Protection Threshold Values

Protection type	threshold	Protection Type	Error
Overtemperature Protection	>85 °C	Software	yes
Overvoltage Power Supply	>62V*	Software	yes
Undervoltage Power Supply	<12VDC*	Software	yes
Overcurrent Protection on motor	>30A	Software/Hardware	yes
Overcurrent Protection on DC Bus	>20A	Hardware, deleyed Fuse	no
Overcurrent on Logic Supply	>1,1A	Hardware, poliswitch reverable Fuse	No

*Parametrisable with UI

Motor Power Company s.r.l.

Via Leonardo Da Vinci, 4
42024 Castelnovo Sotto Reggio Emilia - Italia
Tel. +39 0522 682710 - Fax +39 0522 683552
info@motorpowerco.it - motorpowerco.com
Cap. Soc. 250.000,00€ i.v. - R.E.A. di RE 175521
Iscr.Reg.Impr. di RE n.01308390358 - N. Mecc. RE 010210
C.F. e P.IVA IT 01308390358



Motor Power Company s.r.l.

Via Leonardo Da Vinci, 4
42024 Castelnovo Sotto Reggio Emilia - Italia
Tel. +39 0522 682710 - Fax +39 0522 683552
info@motorpowerco.it - motorpowerco.com
Cap. Soc. 250.000,00€ i.v. - R.E.A. di RE 175521
Iscr.Reg.Impr. di RE n.01308390358 - N. Mecc. RE 010210
C.F. e P.IVA IT 01308390358

