

# FLEXI PRO Servo Drive

## User Manual

120/240 VAC and 400/480 VAC

Revision: 8.6

Firmware Version 1.41.x

Software Version: 1.41.x.x

DOC-FLEXI PRO-UM-EN



SEE IT BEFORE IT HAPPENS

**MOTOR  
POWER**  
COMPANY

Introduction	1
Safety and Standards	2
Specifications	3
Wiring	4
Drive Setup	5
Application Setup	6
Motor Setup	7
Operation	8
Tuning	9
Diagnostics and Troubleshooting	10
Accessories	11



## Revision History

Document Revision	Date	Remarks
8.6	Feb. 2017	Firmware 1.41.10. Minor content update.
8.5	Jan.2017	Firmware 1.41.10. Updated faults/warnings/errors. Updated multi-turn encoder. Added note in Standards Compliance.
8.4	Oct. 2016	Firmware 1.41.4. Updated info: hazardous materials (ROHS 2.0 China); mounting; controller I/F; gearing opmode; firmware update over EtherCAT; serial baud rate
8.3	May 2016	Firmware 1.41.2.
8.2	May 2016	Firmware 1.41.2. General release.
8.1	Feb.2016	Firmware 1.40.0. Limited release.
8.0	Nov. 2015	Firmware 1.20.7. Internal release.
7.2	Mar.2015	Firmware 1.15.24
7.0/7.1	Jan. 2015	Firmware 1.15.xx
6.0/6.1	Mar.2014	Firmware 1.4.6
5.2	Jan. 2014	Firmware 1.4.5
5.1	Oct. 2013	Firmware 1.4.4.
5.0	Sep. 2013	Firmware 1.4.x.

## Copyright Notice

© 2017 Motor Power Company s.r.l.

All rights reserved. No part of this work may be reproduced or transmitted in any form or by any means without prior written permission of Motor Power Company s.r.l.

## Disclaimer

This product documentation was accurate and reliable at the time of its release. Motor Power Company s.r.l. reserves the right to change the specifications of the product described in this manual without notice at any time.

## Trademarks

Flexi SUITE and sensAR are trademarks of Motor Power Company s.r.l.

CANopen and CiA are registered trademarks of the CAN in Automation User's Group

EtherCAT is a registered trademark of Beckhoff Automation GmbH

EnDat is a registered trademark of Dr. Johannes Heidenhain GmbH

HIPERFACE is a registered trademark of Sick Stegmann GmbH

BiSS-C is a registered trademark of iC-Haus GmbH

Windows is a registered trademark of Microsoft Corporation

---

## Contact Information

Motor Power Company s.r.l.  
Via Leonardo Da Vinci , 4  
42024 Castelnovo Sotto  
Reggio Emilia - Italia  
Tel: +39 0522 682710  
Fax: +39 0522 683552  
Website: [www.motorpowerco.com](http://www.motorpowerco.com)

## Technical Support

If you need assistance with the installation and configuration of the FLEXI PRO drive, contact Motor Power Company Technical Support: [info@motorpowerco.it](mailto:info@motorpowerco.it)

## Customer Service

Motor Power Company is committed to delivering quality customer service and support for all our products. Our goal is to provide our customers with the information and resources so that they are available, without delay, if and when they are needed. In order to serve in the most effective way, we recommend that you contact your local sales representative for order status and delivery information, product information and literature, and application and field technical assistance. If you are unable to contact your local sales representative for any reason, please use the most relevant of the contact details below:

For Technical Support, contact: [info@motorpowerco.it](mailto:info@motorpowerco.it)

To order products, contact: [info@motorpowerco.it](mailto:info@motorpowerco.it)

For all other inquiries regarding FLEXI PRO drives or other Motor Power Company products, contact: [info@motorpowerco.it](mailto:info@motorpowerco.it)

## Warranty

The warranty is valid for 12 months from the date of shipment and applies only if material or workmanship is found to be defective. The warranty will be invalid if the customer fails to install, operate or maintain the product in accordance with the instructions in this user manual<sup>1</sup>.

During the warranty period, the owner must pay the cost of shipping the product to the factory for repair, and Motor Power Company will pay for shipping the repaired product to the customer.

After the warranty period has expired, all shipping costs will be the responsibility of the customer.

Before returning the product, the customer must first request a Return Materials Authorization (RMA) number from Motor Power Company by email to [info@motorpowerco.it](mailto:info@motorpowerco.it)

The complete Warranty Statement can be found in the Terms and Conditions document on the Motor Power Company website: [info@motorpowerco.com](http://info@motorpowerco.com)

<sup>1</sup>When Flexi Pro drives are delivered with TC-E motors (only when supplied as a bundle, i.e. TCE motor with matching Flexi Pro drive together as a combination) the drive warranty period consists of 30 months).

## **Unpacking**

The package contains the FLEXI PRO drive only.

Upon receipt, open the package and remove all packing materials.

Check to ensure there is no visible damage to the FLEXI PRO drive. If damage is detected, notify the carrier immediately.



# Contents

<b>1</b>	<b>Introduction</b>	<b>11</b>
1.1	FLEXI PRO Product Overview	11
1.2	FLEXI PRO Models	12
1.3	Ordering Information	13
1.4	Documentation Set for FLEXI PRO	14
<b>2</b>	<b>Safety and Standards</b>	<b>15</b>
2.1	Safety Overview	15
2.2	Safety Symbols	15
2.3	Safety Instructions	15
2.4	Standards Compliance	17
2.5	STO Certification and Reliability Data	18
2.6	Material Safety Data	18
<b>3</b>	<b>Specifications</b>	<b>19</b>
3.1	Dimensions	19
3.2	Mechanical and Electrical Specifications	23
3.3	Control Specifications	32
3.4	Protective Functions and Environmental Specifications	34
3.5	Communication Specifications	34
3.6	I/O Specifications	35
3.7	Motor Feedback Specifications	37
<b>4</b>	<b>Wiring</b>	<b>39</b>
4.1	FLEXI PRO-1D5/FLEXI PRO-003 (120/240 VAC) Wiring and Pin Assignments	39
4.2	FLEXI PRO-4D5/FLEXI PRO-006 (120/240 VAC) Wiring and Pin Assignments	43
4.3	FLEXI PRO-008/FLEXI PRO-010/FLEXI PRO-013 (120/240 VAC) Wiring and Pin Assignments	47
4.4	FLEXI PRO-020/FLEXI PRO-024 (120/240 VAC) Wiring and Pin Assignments	51
4.5	FLEXI PRO-003/FLEXI PRO-006 (400/480 VAC) Wiring and Pin Assignments	55
4.6	FLEXI PRO-012 (400/480 VAC) Wiring and Pin Assignments	59
4.7	FLEXI PRO-024/FLEXI PRO-030 (400/480 VAC) Wiring and Pin Assignments	64
4.8	Controller Interface Wiring	68
4.9	Machine Interface Wiring	70
<b>5</b>	<b>Drive Setup</b>	<b>73</b>
5.1	Setup Overview	73
5.2	Preparation	73
5.2.1	Hardware and Tools	73
5.2.2	Host Computer System	75
5.2.3	Files for Fieldbus Devices	75
5.3	EMI Suppression	76
5.3.1	CE Filtering Techniques	76
5.3.2	Grounding	76
5.3.3	Shielding and Bonding	77
5.3.4	Input Power Filtering	78
5.3.5	Motor Line Filtering	78
5.3.6	I/O Signal Filtering	79
5.3.7	Additional EMI Suppression Recommendations	79
5.4	Electrical System Considerations	79
5.4.1	Fusing	79
5.4.2	Leakage Current Considerations	80
5.4.3	Residual Current Protective Device (RCD)	80
5.5	Mechanical Installation	81
5.5.1	Mounting the FLEXI PRO	81

5.5.2	Mounting Multiple Units .....	81
5.6	Control Board Connections .....	82
5.6.1	Controller Interface – C2 .....	82
5.6.2	Machine Interface – C3.....	87
5.6.3	Motor Feedback – C4 .....	89
5.6.4	Motor Feedback Wiring Tables .....	91
5.6.5	Motor Brake on Power Block.....	101
5.6.6	Fieldbus Devices – C5 and C6.....	102
5.6.7	Host Computer – C1 and/or C7.....	103
5.6.8	Daisy Chain – C8 .....	104
5.6.9	Drive Address – Rotary Switch .....	104
5.7	Power Board Connections – 120/240 VAC .....	105
5.7.1	STO .....	105
5.7.2	Motor .....	106
5.7.3	Regeneration Resistor .....	107
5.7.4	AC Input Voltage .....	109
5.7.5	Motor Brake (Optional).....	112
5.8	Power Board Connections – 400/480 VAC .....	113
5.8.1	STO .....	113
5.8.2	Logic Power 24V Input .....	114
5.8.3	AC Input and Regeneration Resistor.....	115
5.8.4	Motor Brake .....	116
5.8.5	Motor .....	119
5.9	Regeneration .....	119
5.9.1	Regenerative Energy Overview .....	119
5.9.2	Regeneration Resistance Calculations.....	120
5.9.3	Regeneration Resistor Protection .....	125
5.10	Firmware Update .....	127
5.10.1	Firmware Update Preparation .....	127
5.10.2	Firmware Update Options .....	127
5.10.3	Firmware Update over Serial Connection .....	129
5.10.4	Firmware Update over EtherCAT .....	129
5.10.5	Resuming Operation After Firmware Update.....	133
5.10.6	Ember Mode.....	133
5.11	Power Up.....	134
<b>6</b>	<b>Application Setup</b> .....	<b>135</b>
6.1	Parameters .....	135
6.1.1	Configuration Parameters .....	135
6.1.2	Managing Parameters - Drive Memory .....	135
6.2	Configuration Sequence.....	136
6.3	Communication .....	138
6.3.1	Serial Baud Rate.....	138
6.3.2	CANopen Bit Rate .....	139
6.4	Power Rating.....	139
6.5	Feedback.....	140
6.5.1	Incremental Encoder .....	140
6.5.2	Sine Encoder.....	142
6.5.3	sensAR Absolute Magnetic Encoder .....	142
6.5.4	BiSS-C Interface.....	143
6.5.5	EnDat 2.2 Bidirectional Interface .....	143
6.5.6	Encoder Simulation Output .....	144
6.5.7	Resolver .....	145
6.6	Resolver and Sine Encoder Calibration.....	146
6.6.1	Resolver and Sine Encoder Calibration Overview.....	146
6.6.2	Motor Revolutions Required for Calibration.....	146
6.6.3	Motor Speed Limitations During Calibration.....	147



---

6.6.4	Calibrating Resolver and Sine Encoder.....	147
6.6.5	Sine Encoder and Resolver Diagnostics.....	150
6.7	Motion Units.....	152
6.8	Current Foldback .....	153
6.9	Digital Inputs .....	154
6.10	Digital Outputs.....	154
6.11	Analog Inputs.....	155
6.11.1	Analog Input 1 .....	155
6.11.2	Analog Input 2 .....	155
6.11.3	Using Analog Inputs for Velocity Command and Current Limit .....	156
6.12	Analog Output.....	157
6.13	Homing .....	158
6.13.1	Home at Index with Motor Resolver .....	159
6.13.2	Home at Index with Single/Multi-Turn Encoders .....	159
6.13.3	Home at Positive Edge of Home Switch.....	159
6.14	Disable Mode .....	159
6.14.1	Active Disable .....	160
6.14.2	Dynamic Brake.....	163
6.15	Motor Brake Control via Relay .....	164
6.16	Motor Temperature Sensor .....	166
<b>7</b>	<b>Motor Setup</b> .....	<b>169</b>
7.1	Motor Setup Wizard .....	169
7.2	Drive Identification .....	173
7.3	Motor Identification.....	174
7.4	Motor Initialization.....	174
7.5	Current Limits .....	175
7.6	Velocity Limits.....	175
7.7	Position Limits.....	176
7.8	Motor Direction.....	176
7.9	New Motor Wizard .....	177
<b>8</b>	<b>Operation</b> .....	<b>181</b>
8.1	Drive Enable .....	181
8.2	Operation Modes .....	181
8.3	Current Operation.....	183
8.3.1	Serial Current Operation Mode .....	183
8.3.2	Analog Current Operation Mode.....	183
8.3.3	Current Control Loop.....	183
8.4	Velocity Operation .....	183
8.4.1	Serial Velocity Operation Mode .....	183
8.4.2	Analog Velocity Operation Mode .....	183
8.4.3	Velocity Control Loops .....	183
8.5	Position Operation .....	187
8.5.1	Serial Positioning Operation Mode.....	187
8.5.2	Position Control Loop .....	189
8.6	Gearing Operation Mode .....	189
8.6.1	Pulse and Direction Mode.....	191
8.6.2	Master/Slave – Encoder Follower .....	194
8.6.3	Up/Down Counting.....	195
<b>9</b>	<b>Tuning</b> .....	<b>197</b>
9.1	FLEXI PRO HD Controller .....	197
9.2	FLEXI PRO HD Controller Autotuning .....	198
9.3	PC-Based Autotuning .....	199
9.4	Drive-Based Autotuning.....	202
9.4.1	Drive-Based Autotuning – Overview .....	202
9.4.2	Drive-Based Autotuning – Express .....	203
9.4.3	Drive-Based Autotuning – Advanced .....	203

---

---

9.5	Autotuning Parameters Summary .....	208
9.6	Recording and Evaluating Performance.....	210
9.6.1	Diagnostics .....	210
9.6.2	Recording Data in Flexi SUITE .....	211
9.6.3	Recording Data in Terminal.....	213
9.6.4	Evaluating PTPVCMD .....	214
9.6.5	Evaluating ICMD and/or PE Oscillations .....	214
9.7	Low Pass Filter on Current Command .....	215
9.8	Gearing Filters.....	217
9.9	Move Smoothing Filter.....	218
9.10	Notch Filters .....	219
9.11	Anti-Vibration Filters .....	219
9.12	Gains – Manual Tuning .....	224
9.13	Flexibility Compensation Tuning .....	227
9.14	Tuning Issues – Q&A.....	228
<b>10</b>	<b>Diagnostics and Troubleshooting</b> .....	<b>229</b>
10.1	Report Generator.....	229
10.2	Faults and Warnings .....	229
10.3	Fault, Warning and Error Codes and Messages .....	230
10.3.1	Warnings .....	230
10.3.2	Faults.....	232
10.3.3	Errors.....	235
10.4	Fieldbus Status – LEDs .....	239
10.4.1	CANopen .....	239
10.4.2	EtherCAT .....	239
10.5	Drive Status – 7-Segment Display .....	240
10.6	7-Segment Code Descriptions .....	241
<b>11</b>	<b>FLEXI PRO Accessories</b> .....	<b>293</b>
11.1	Line Filters.....	293
11.2	Regeneration Resistors.....	294
11.3	D9-RJ45 Adapter .....	295

# 1 Introduction

## 1.1 FLEXI PRO Product Overview

The FLEXI PRO is a full-featured, high-performance servo drive featuring innovative technologies and industry-leading power density.

Refer to the part number diagrams in the section *Ordering Information* for the various options for the FLEXI PRO drive.

The **120/240V** product models are shown in Figure 1-1:



**Figure 1-1. FLEXI PRO 120/240 VAC Models**

The **400/480V** product models are shown in Figure 1-1:



**Figure 1-2. FLEXI PRO 400/480 VAC Models**

## 1.2 FLEXI PRO Models

The various models in the FLEXI PRO servo drive series are differentiated by means of the communication methods and protocols they use. The following table presents the different models and their distinguishing characteristics.

**Table 1-1. FLEXI PRO Models - Communication and Protocols**

<b>FLEXI PRO Model</b>	<b>Physical Layer</b>	<b>Communication Protocol</b>	<b>Program Language</b>
<b>FLEXI PRO Power Block (PB)</b>	PWM signals	PWM signals	PMAC (Delta Tau)
<b>FLEXI PRO (AP)</b> Standard FLEXI PRO model.	<b>Serial</b> (RS232)	<b>ASCII</b> commands	VarCom
	Analog	±10V	
	Pulse Train	AB signals	
<b>FLEXI PRO CAN (AF)</b> A CAN drive, which uses <b>CANopen</b> protocol. Referred to as FLEXI PRO CANopen drive.	Serial (USB RS232)	ASCII commands	VarCom
	Analog	±10V	
	Pulse Train	AB signals	
	<b>CAN</b>	Communication: <b>CANopen</b> – all 1000h objects Manufacturer-Specific: CANopen – all 2000h objects Standard Servo-Drive (Motion): CANopen – all 6000h objects	VarCom CANopen
<b>FLEXI PRO EtherCAT (EC)</b> An EtherCAT drive, which uses <b>CANopen over EtherCAT (CoE)</b> protocol.	Serial (USB RS232)	ASCII commands	VarCom
	Analog	±10V	
	Pulse Train	AB signals	
	<b>Ethernet</b>	Communication: <b>EtherCAT</b> Manufacturer-Specific: CANopen – all 2000h objects Standard Servo-Drive (Motion): CANopen – all 6000h objects	VarCom CANopen
<b>FLEXI PRO EtherCAT (EB)</b> An EtherCAT drive, which uses <b>CANopen over EtherCAT (CoE)</b> protocol	Serial (USB)	ASCII commands	VarCom
	Analog	±10V	
	<b>Ethernet</b>	Communication: <b>EtherCAT</b> Manufacturer-Specific: CANopen – all 2000h objects Standard Servo-Drive (Motion): CANopen – all 6000h objects	VarCom CANopen

### 1.3 Ordering Information

The following diagram shows the ordering options that comprise the various model numbers of the drives in the FLEXI PRO product line.

These are the currently available ordering options. For inquiries about product availability, contact Motor Power Company.

FLEXI PRO DRIVE TYPE

<b>FPRO</b>	<b>006</b>	<b>2A</b>	<b>AP</b>	<b>1</b>	<b>XXX</b>
Drive Name	Rating	AC and Controller Input Power Supply	Interface Options	Analog Input	Special Specification
1	2	3	4	5	

**1**

Rating		
120/240 VAC		
	Cont. [A rms]	Peak [A rms]
1D5	1.5	4.5
003	3	9
4D5	4,5	18
006	6	18
008	8	28
010	10	28
013	13	28
020	20	48
024	24	48

Rating		
400/480 VAC		
	Cont. [A rms]	Peak [A rms]
003	3	9
006	6	18
012	12	24
024	24	72
030	30	90

**2** AC and Controller Input Power Supply

2A	Input Single Phase 120L - L VAC +10% -15% 50/60Hz
	Input Single Phase 240L - L VAC +10% -15% 50/60Hz
	Input Three Phase 120 - 240L - L VAC +10% -15% 50/60Hz
4D	AC Input Power Supply:
	- Input Three Phase 400L - L VAC +10% -15% 50/60Hz
	- Input Three Phase 480L - L VAC +10% -15% 50/60Hz
	24VDC input for control board power supply

**3** Interface Options

AF - Analog Voltage/Pulse Train Ref & CANopen® & USB & RS 232

EC - EtherCAT, USB, RS232

EB - EtherCAT, USB (two analog inputs only)

**4** Analog Input

1 - One Analog input, 16 bit

2 - Two Analog inputs, 14 bit each

**Figure 1-3. FLEXI PRO Ordering Options**

## 1.4 Documentation Set for FLEXI PRO

The documentation set for the **FLEXI PRO** servo drive consists of the following manuals:

- **FLEXI PRO User Manual.** Hardware setup, operation and tuning. Intended for persons who are qualified to transport, assemble, commission, and maintain the drive.
- **Flexi SUITE Reference Manual.** Graphical user interface (GUI) provided with the FLEXI PRO for configuring, operating and tuning the drive.
- **VarCom Reference Manual.** Parameters and commands for configuring, operating and tuning the drive.
- **EtherCAT and CANopen Reference Manual.** FLEXI PRO implementation of CANopen protocol for FLEXI PRO EtherCAT (EC and EB) and CAN (AF) drives.
- **FLEXI PRO Quick Start Guide.** Basic setup and operation of the drive.
- **FLEXI PRO Functional Safety Reference Manual**
- **FLEXI PRO Technical Training Manual.** For use with FLEXI PRO Demo Kit and Flexi SUITE software for learning to configure and operate the FLEXI PRO drive.

## 2 Safety and Standards

### 2.1 Safety Overview

Only qualified persons may perform the installation procedures. You do not need to be an expert in motion control to install and operate the drive system. However, you must have a basic understanding of electronics, computers, mechanics, and safety practices.



**The FLEXI PRO utilizes hazardous voltages. Be sure the drive is properly grounded.**



When connecting the FLEXI PRO to other control equipment, be sure to follow two basic guidelines to prevent damage to the drive:





- The FLEXI PRO must be grounded via the earth ground of the main AC voltage supply.
- Any motion controller, PLC or PC that is connected to the FLEXI PRO must be grounded to the same earth ground as the FLEXI PRO.

Before you install the FLEXI PRO, review the safety instructions in the product documentation. Failure to follow the safety instructions may result in personal injury or equipment damage.

### 2.2 Safety Symbols

Safety symbols indicate a potential for personal injury or equipment damage if the recommended precautions and safe operating practices are not followed.

The following safety-alert symbols are used on the drive and in the documentation:

	<b>Caution</b>	ISO 7000-0434 (2004-01)
	<b>Warning.</b> Dangerous voltage.	IEC 60417-5036 (2002-10)
	Protective earth; functional ground	IEC 60417-5019 (2006-08)
	Caution, hot surface	IEC 60417-5041 (2000-10)

### 2.3 Safety Instructions

- Read all available product documentation before assembling and commissioning. Incorrect handling of this product may cause personal injury and/or damage to equipment. Adhere strictly to the installation instructions and requirements.

- All system components must be connected to ground. Electrical safety is provided through a low-resistance earth ground connection. (Protective Class 1 according standard EN/IEC 618005-1.) Motor should be connected to protective earth by independent earthing conductor rated not less than the motor wire. This product contains static sensitive components that can be damaged by incorrect handling. Avoid contact with high insulating materials (artificial fabrics, plastic film, etc.). Place the product on a conductive surface. Ground yourself (discharge any possible static electricity build-up) by touching an unpainted, metal, grounded surface.
- Keep all covers and cabinet doors shut during operation. Otherwise, potential hazards may cause personal injury and/or damage to equipment.
- During operation the product has electrically charged components and hot surfaces. The heat sink can reach temperatures of 90°C. Control and power cables can carry a high voltage, even when the motor is not rotating.
- To avoid electric arcing and hazards to personnel and electric contacts, never disconnect or connect the product while the power source is energized.
- After removing the power source from the equipment, wait at least 5 minutes before touching or disconnecting sections of the equipment that normally carry electrical charges (e.g., capacitors, contacts, screwed connections). For safety, measure the electrical contact points with a meter before touching the equipment. Wait until the voltage drops below 30 VAC before handling components.
- Provide a power mains disconnect device in according with local regulations.
- Before testing and setting up, the manufacturer of the machine must generate a hazard analysis for the machine, and take appropriate measures to ensure that unforeseen movements cannot cause injury or damage to any person or property.
- Since the drive meets IP20 according to IEC 60529, and type 1 according to UL 50, the end user must select an enclosure that permits safe operation of the drive. The enclosure must meet at least IP54 according to IEC 60529, and at least type 2 according to UL 50, and be made of metal or material with rating flammability of 5 VA, and not have any openings in the bottom.
- Since the leakage current to PE is greater than 3.5 mA, compliance with IEC61800-5-1 and UL 508C requires either doubling of the PE connection (by one grounding connection through the mains power cable earthing wire, and another connection through the heat sink connection to the grounded machine base), or the use of a copper connecting cable with a cross-section greater than 10 mm<sup>2</sup>. Use the drive mount screws and the PE connection screws to meet this requirement.
- Wiring of green color with or without one or more yellow stripes must not be used except for protective bonding.
- Power cables should be rated at least 600V, 75°C.
- The STO input is functional in all FLEXI PRO models but not yet independently certified in certain models. Refer to the *FLEXI PRO Functional Safety Reference Manual*.
- Drives with a suspended load must have an additional mechanical safety block (such as a motor-holding brake). The drive cannot hold the load when STO is active. Serious injury could result if the load is not properly safeguarded.



## 2.4 Standards Compliance

The FLEXI PRO has been tested and according to the following standards.

**Table 2-1. Standards Compliance**

Standard	Directive/Description	Certif. Mark
<b>IEC 61800-5-1</b>	<b>Low Voltage Directive 2006/95/EC</b> Adjustable speed electrical power drive systems.	
<b>IEC 61800-3</b>	<b>Electromagnetic Compatibility (EMC) Directive 2004/108/E</b> Adjustable speed electrical power drive systems.	
<b>EN 50581</b>	<b>European Regulations 2011/65/EU RoHS (Restriction of Hazardous Substances)</b> Technical documentation required for declaring compliance with the applicable substance restrictions.	
<b>SJ/T 11364</b>	<b>Marking for the Restricted Use of Hazardous Substances in Electronic and Electrical Products (China RoHS 2.0)</b> Hazardous substances in electronic and electrical products; environmental protection use period and recyclability.	
<b>UL 508C</b>	<b>Power Conversion Equipment</b> Open or enclosed equipment that supplies power to control a motor or motors operating at a frequency or voltage different than that of the input supply.	
<b>CSA C22.2 NO. 14-10</b>	<b>Industrial Control Equipment</b> Control and protective devices, and accessory devices, rated at not more than 1500V, for starting, stopping, regulating, controlling, or protecting electric motors, generators, heating apparatus, or other equipment used to control an industrial process that is intended to be installed and used in non-hazardous locations.	
<b>EU REACH</b>	<b>Regulation (EC) 1907/2006 Concerning the Registration, Evaluation, Authorization and Restriction of Chemicals.</b> The production and use of chemical substances, and their potential impacts on both human health and the environment.	

**IEC** International Electrotechnical Commission

**EN** European Standard (Euro Norm)

**UL** Underwriters Laboratory

**CSA** Canadian Standards Association

**EU** European Parliament and Council of the European Union

**Note:** CE and UL certification is pending for FLEXI PRO-024/FLEXI PRO-030 (400/480 VAC) models; they are currently undergoing testing.

## 2.5 STO Certification and Reliability Data

For complete details, refer to *FLEXI PRO Functional Safety Reference Manual*.

## 2.6 Material Safety Data

The FLEXI PRO is marked is in accordance with SJ/T 11364, which applies to electronic and electrical products sold in the People's Republic of China.

The data in the Hazardous Substances table below is in accordance with China RoHS 2.0: Administrative Measures for the Restriction of Hazardous Substances in Electric Appliances and Electronic Products; released January 21, 2016.



FLEXI PRO contains certain hazardous substances, and can be used safely for 20 years, after which it should enter the recycling system.

**Table 2-2. Hazardous Substances**

Part Name	Lead (Pb)	Mercury (Hg)	Cadmium (Cd)	Hexavalent Chromium (Cr (VI))	Polybrominated biphenyls (PBB)	Plybrominated diphenyl ethers (PBDE)
Metal parts	X	O	O	O	O	O
Plastic parts	O	O	O	O	O	O
Electronic	X	O	O	O	O	O
Contacts	O	O	O	O	O	O
Cables and cabling accessories	O	O	O	O	O	O

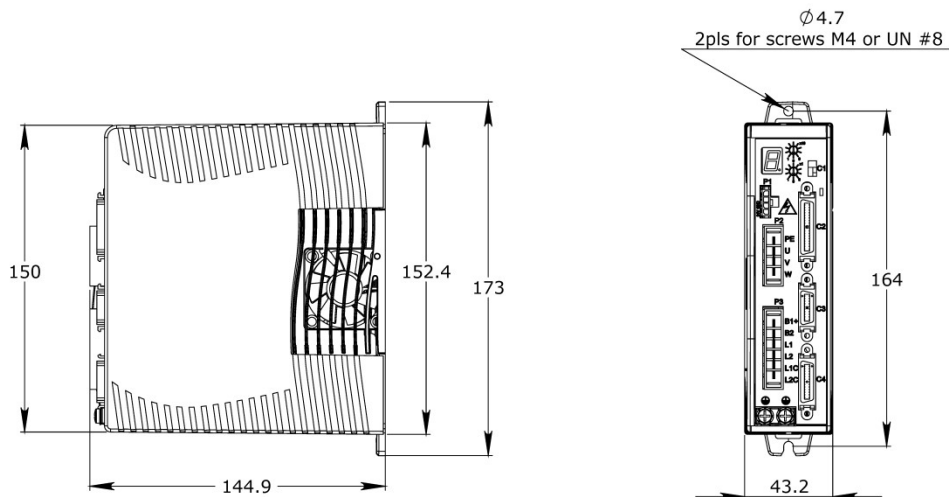
**O**: Indicates that the concentration of hazardous substance contained in all of the homogeneous materials for this product is below the limit stipulated in GB/T 26572.

**X**: Indicates that the concentration of hazardous substance contained in at least one of the homogeneous materials used for this product is above the limit stipulated in GB/T 26572.

# 3 Specifications

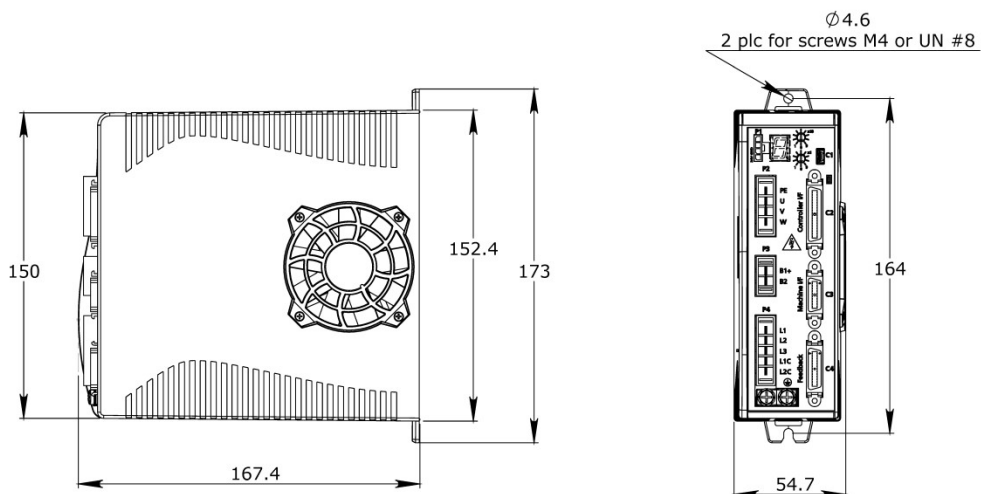
## 3.1 Dimensions

A number of different frames house the various models of FLEXI PRO drives and power blocks. The exterior dimensions of the frames are shown in Figure 3-1 through Figure 3-7.

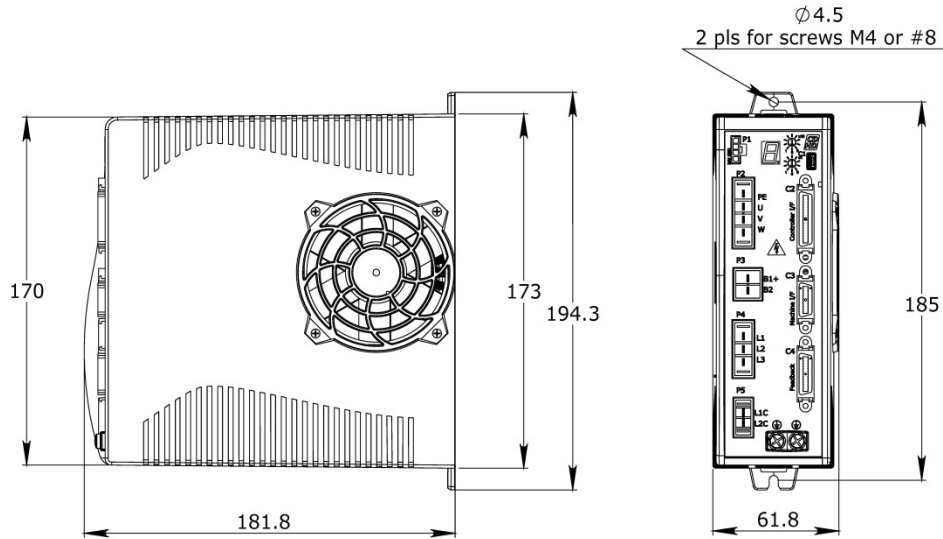


**Figure 3-1. FLEXI PRO-1D5/FLEXI PRO-003 (120/240 VAC) – Dimensions (mm)**

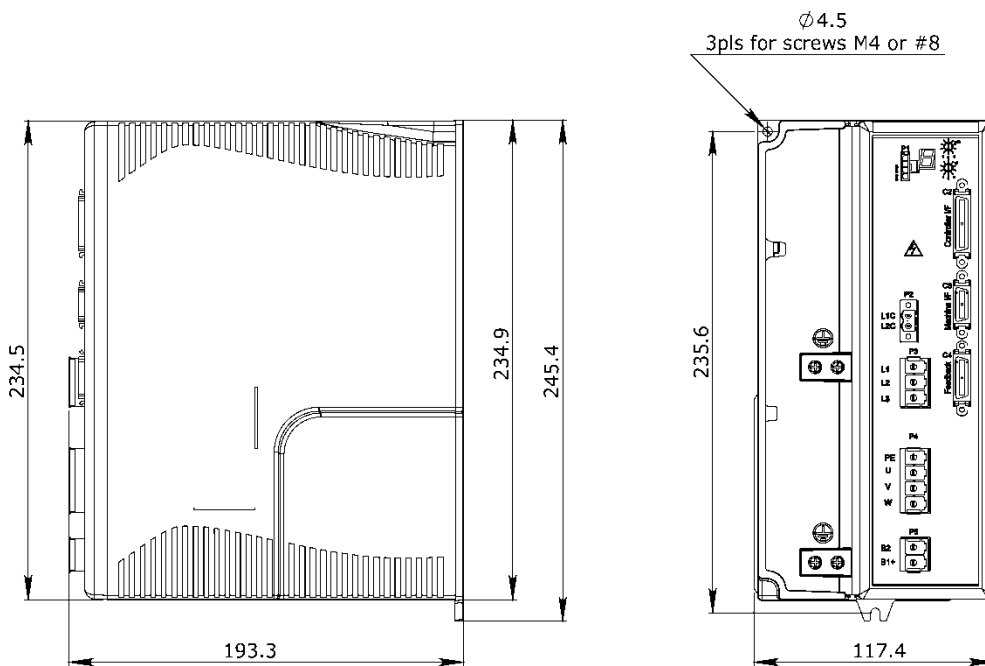
**Note:** FLEXI PRO-1D5 does not have a fan.



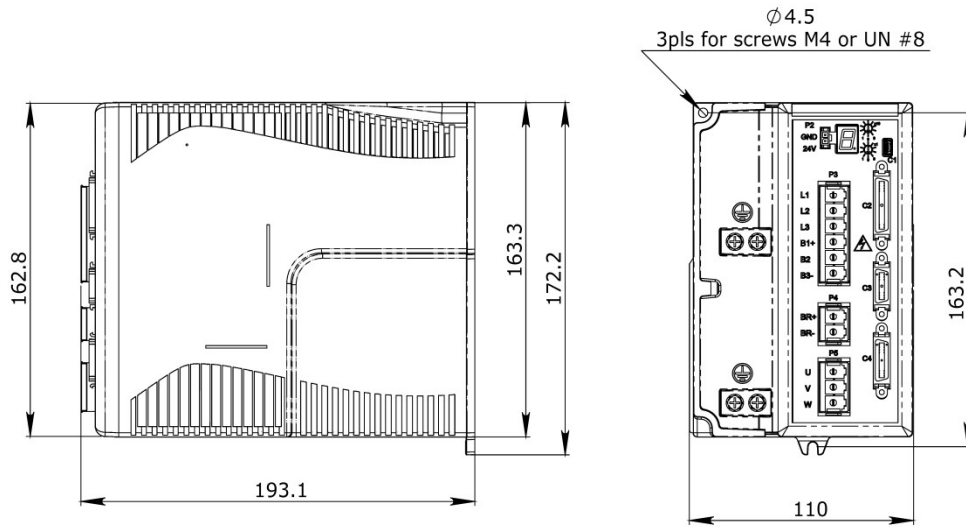
**Figure 3-2. FLEXI PRO-4D5/FLEXI PRO-006 (120/240 VAC) – Dimensions (mm)**



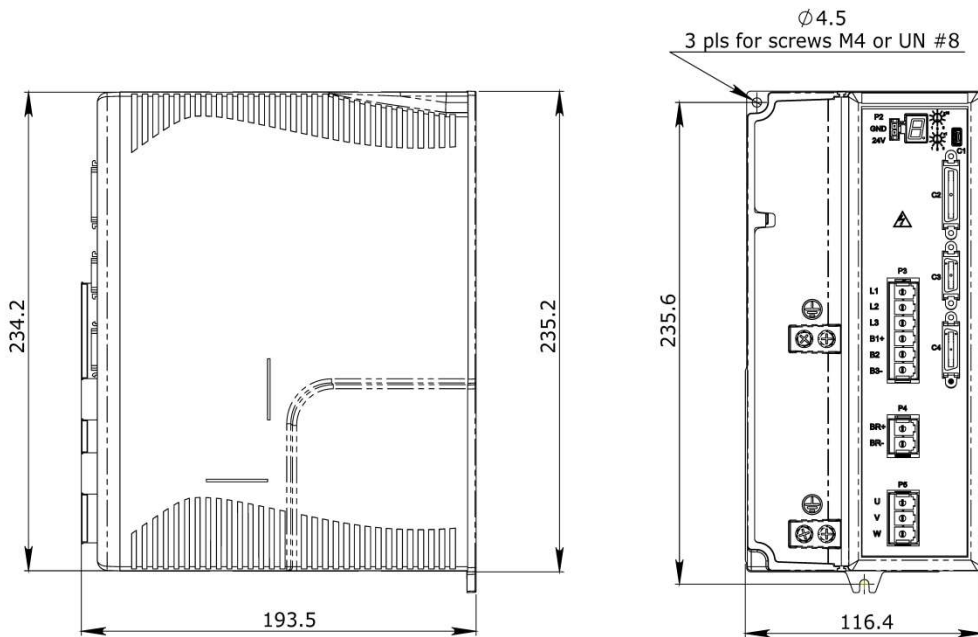
**Figure 3-3. FLEXI PRO-008/FLEXI PRO-010/FLEXI PRO-013 (120/240 VAC) – Dimensions (mm)**



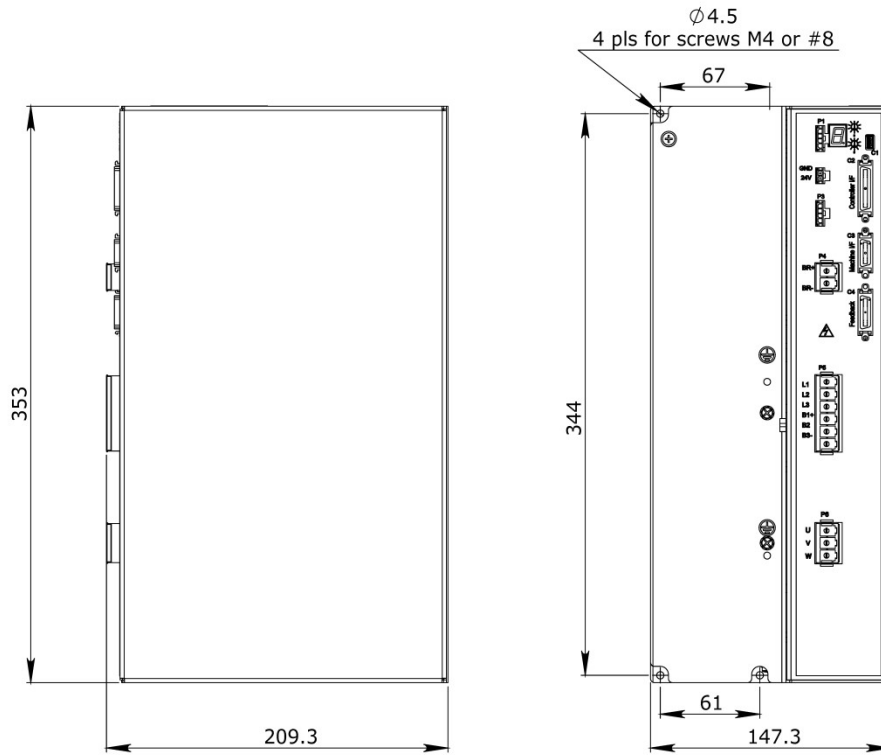
**Figure 3-4. FLEXI PRO-020/FLEXI PRO-024 (120/240 VAC) – Dimensions (mm)**



**Figure 3-5. FLEXI PRO-003/FLEXI PRO-006 (400/480 VAC) – Dimensions (mm)**



**Figure 3-6. FLEXI PRO-012 (400/480 VAC) – Dimensions (mm)**



**Figure 3-7. FLEXI PRO-024/FLEXI PRO-030 (400/480 VAC) – Dimensions (mm)**

## 3.2 Mechanical and Electrical Specifications

**Table 3-1. Mechanical & Electrical Specifications –  
FLEXI PRO-1D5/FLEXI PRO-003(120/240 VAC)**

Single Phase 120/240 VAC	Specification	FLEXI PRO- 1D5	FLEXI PRO- 003
<b>Ratings</b>			
Input Power Circuit (L1, L2)	Voltage (VAC Line-Line) Nominal $\pm 10\%$	120/240	120/240
	Line Frequency (Hz)	50/60	50/60
	120/240 VAC	1 Phase	1 Phase
	Continuous Current (1 ph A rms)	2.5	5
	Line Fuses (FRN-R, LPN, or equivalent) (A)	4	6
	Withstand Voltage (Primary to Earth)	1500 VAC (2121 VDC)	1500 VAC (2121 VDC)
Control Circuit Input Power (L1C, L2C)	120 $\pm 10$ or 240 $\pm 10$ VAC	1 Phase	1 Phase
Logic Input Fuse (Time Delay)	120 or 240 VAC (A)	0.5	0.5
STO (Safe Torque Off)	STO Power Supply (VDC)	24 $\pm 10\%$	24 $\pm 10\%$
STO Fuse (Time Delay)	120 or 240 VAC (A)	1.5	1.5
Motor Output (U, V, W)	Continuous Output Current (A rms)	1.5	3
	Continuous Output Current (A peak)	2.12	4.24
	Peak Output Current (A rms) for 2 seconds	4.5	9
	Peak Output Current (A peak) for 2 seconds	6.3	12.72
	kVA at 120 VAC	0.28	0.44
	kVA at 240 VAC	0.37	0.74
	PWM Frequency (kHz)	16	16
Soft Start	Max. Surge Soft Start Current (A)	7	7
	Max. Charge Time (ms)	350	350
Power Circuit Loss	W		
Control Circuit Loss	W	5	5
Total Power Loss	W		
<b>Hardware</b>			
Unit Weight	kg	0.7	0.75
Connection Hardware	PE Ground Screw Size/Torque	M4/1.35 Nm	M4/1.35 Nm
Wire Size	Control Circuit (AWG) up to 3 meters	24-28	24-28
	Main Circuit Motor Lines (AWG)	18	18
	Main Circuit AC Inputs (AWG)	18	18
	PE Ground Screw	M4	M4
Clearance Distance	Side-to-Side (mm)	15	15
	Top/Bottom (mm)	50	50
<b>Voltage Trip</b>			
	Under-Voltage Trip (Nominal) (VDC)	100	100
	Over-Voltage Trip (VDC)	420	420

Single Phase 120/240 VAC	Specification	FLEXI PRO- 1D5	FLEXI PRO- 003
<b>Power Temperature</b>			
Fan	Normally operates at quarter power; when temperature exceeds high-speed fan trigger temperature, operates at full power	No	Yes
	Power Module Over-Temperature Fault Regulated (°C)	80 ±5%	80 ±5%
	Power Module Over-Temperature Fault Non-regulated (°C)	100 ±5%	100 ±5%
	Trigger Temperature for High Speed Fan (°C)	NA	45
<b>External Regenerative Resistor (B1+, B2)</b>			
External regenerative resistor requirement (regen resistor not supplied with drive)	Peak Current (A)	6.3	12.7
	Minimum Resistance (Ω)	64	31.5
	Power Rating (W)	System-dependent	System-dependent
Application Information	Internal Bus Capacitance (μF)	360	660
	VLOW (Regen Circuit Turn Off) (VDC)	380	380
	VMAX (Regen Circuit Turn On) (VDC)	400	400

**Table 3-2. Mechanical & Electrical Specifications – FLEXI PRO-4D5/FLEXI PRO-006 (120/240 VAC)**

Single and Three-Phase 120/240 VAC	Specification	FLEXI PRO- 4D5	FLEXI PRO- 006
<b>Ratings</b>			
Input Power Circuit (L1, L2, L3)	Voltage (VAC Line-Line*) Nominal ±10%	120/240	120/240
	Line Frequency (Hz)	50/60	50/60
	120 VAC	1 Phase or 3 Phase	1 Phase or 3 Phase
	240 VAC	1 Phase	1 Phase
	Continuous Current (1/3 ph A rms)	8.5/4	10/5.8
	Line Fuses (FRN-R, LPN, or equivalent)	10	10
	Withstand Voltage (Primary to Earth)	1500 VAC (2121 VDC)	1500 VAC (2121 VDC)
Control Circuit Input Power (L1C, L2C )	120 ±10 or 240 ±10 VAC	1 Phase	1 Phase
Logic Input Fuse (Time Delay)	120 or 240 VAC (A)	0.5	0.5
STO (Safe Torque Off)	STO Power Supply (VDC)	24 ±10%	24 ±10%
STO Fuse (Time Delay)	120 or 240 VAC (A)	1.5	1.5



FLEXI PRO

Single and Three-Phase 120/240 VAC	Specification	FLEXI PRO-4D5	FLEXI PRO-006
Motor Output (U, V, W)	Continuous Output Current (A rms)	4.5	6
	Continuous Output Current (A peak)	6.63	8.48
	Peak Output Current (A rms) for 2 seconds	18	18
	Peak Output Current (A peak) for 2 seconds	25.45	25.45
	kVA at 120 VAC	0.5	0.7
	kVA at 240 VAC	1.1	1.5
	PWM Frequency (kHz)	16	16
Soft Start	Max. Surge Soft Start Current (A)	7	7
	Max. Charge Time (ms)	250	250
Power Circuit Loss	W		
Control Circuit Loss	W	5	5
Total Power Loss	W		
<b>Hardware</b>			
Unit Weight	kg	0.97	0.97
Connection Hardware	PE Ground Screw Size/Torque	M4/1.35 Nm	M4/1.35 Nm
Wire Size	Control Circuit (AWG) up to 3 meters	24-28	24-28
	Main Circuit Motor Lines (AWG)	16	16
	Main Circuit AC Inputs (AWG)	16	16
	PE Ground Screw	M4	M4
Clearance Distance	Side-to-Side (mm)	15	15
	Top/Bottom (mm)	50	50
<b>Voltage Trip</b>			
	Under-Voltage Trip (Nominal) (VDC)	100	100
	Over-Voltage Trip (VDC)	420	420
<b>Power Temperature</b>			
Fan	Normally operates at quarter power; when temperature exceeds high-speed fan trigger temperature, operates at full power	Yes	Yes
	Power Module Over-Temperature Fault Regulated (°C)	80 ±5%	80 ±5%
	Power Module Over-Temperature Fault Non-regulated (°C)	100 ±5%	100 ±5%
	Trigger Temperature for High Speed Fan (°C)	45	45
<b>External Regenerative Resistor (B1+, B2)</b>			
External regenerative resistor requirement (regen resistor not supplied with drive)	Peak current (A)	25.5	25.5
	Minimum resistance (Ω)	16	16
	Power Rating (W)	System-dependent	System-dependent
Application Information	Internal Bus Capacitance (μF)	1120	1120
	VLOW (Regen Circuit Turn Off) (VDC)	380	380
	VMAX (Regen Circuit Turn On) (VDC)	400	400

\*Line to Line: L1 to L2, or L1 to L3 or L2 to L3

**Table 3-3. Mechanical & Electrical Specifications –  
FLEXI PRO-008/FLEXI PRO-010/ FLEXI PRO-013 (120/240 VAC)**

Single and Three Phase 120/240 VAC	Specification	FLEXI PRO-008	FLEXI PRO-010	FLEXI PRO-013**
<b>Ratings</b>				
Input Power Circuit (L1, L2, L3)	Voltage (VAC Line-Line*) Nominal $\pm 10\%$	120/240	120/240	120/240
	Line Frequency (Hz)	50/60	50/60	50/60
	120/240 VAC	1/3 Phase	1/3 Phase	3 Phase
	Continuous Current (3 ph A rms)	5	8	10
	Line Fuses (FRN-R, LPN, or equivalent)	10	10	15
	Withstand Voltage (Primary to Earth)	1500 VAC (2121 VDC)	1500 VAC (2121 VDC)	1500 VAC (2121 VDC)
Control Circuit Input Power (L1C, L2C)	120 $\pm 10$ or 240 $\pm 10$ VAC	1 Phase	1 Phase	1 Phase
Logic Input Fuse (Time Delay)	120 or 240 VAC (A)	0.5	0.5	0.5
STO (Safe Torque Off)	STO Power supply (VDC)	24 $\pm 10\%$	24 $\pm 10\%$	24 $\pm 10\%$
STO Fuse (Time Delay)	120 or 240 VAC (A)	1.5	1.5	1.5
Motor Output (U, V, W)	Continuous Output Current (A rms)	8	10	13
	Continuous Output Current (A peak)	11.31	14.14	18.38
	Peak Output Current (A rms) for 2 seconds	28	28	28
	Peak Output Current (A peak) for 2 seconds	39.56	39.56	39.56
	kVA at 120 VAC	1.1	1.3	1.7
	kVA at 240 VAC	1.7	2.2	2.8
	PWM Frequency (kHz)	8	8	8
Soft Start	Max. Surge Soft Start Current (A)	15	15	15
	Max. Charge Time (ms)	350	350	350
Power Circuit Loss	W			
Control Circuit Loss	W	5	5	5
Total Power Loss	W			
<b>Hardware</b>				
Unit Weight	kg	1.15	1.15	1.15
Connection Hardware	PE Ground Screw Size/Torque	M4/1.35 Nm	M4/1.35 Nm	M4/1.35 Nm
Wire Size	Control Circuit (AWG) up to 3 meters	24-28	24-28	24-28
	Main Circuit Motor Lines (AWG)	14	14	14
	Main Circuit AC Inputs (AWG)	14	14	14
	PE Ground Screw	M4	M4	M4
Clearance Distance	Side-to-Side (mm)	15	15	15
	Top/Bottom (mm)	50	50	50
<b>Voltage Trip</b>				
	Under-Voltage Trip (nominal) (VDC)	100	100	100
	Over-Voltage Trip (VDC)	420	420	420

FLEXI PRO

Single and Three Phase 120/240 VAC	Specification	FLEXI PRO-008	FLEXI PRO-010	FLEXI PRO-013**
<b>Power Temperature</b>				
Fan	Normally operates at quarter power; when temperature exceeds high-speed fan trigger temperature, operates at full power	Yes	Yes	Yes
	Power Module Over-Temperature Fault Regulated (°C)	80 ±5%	80 ±5%	80 ±5%
	Power Module Over-Temperature Fault Non-regulated (°C)	100 ±5%	100 ±5%	100 ±5%
	Power Module Over-Temperature Fault (°C)	100	100	100
	Trigger Temperature for High Speed Fan (°C)	45	45	45
<b>External Regenerative Resistor (B1+, B2)</b>				
External regenerative resistor requirement (regen resistor not supplied with drive)	Peak current (A)	40	40	40
	Minimum resistance (Ω)	10	10	10
	Power Rating (W)	System-dependent	System-dependent	System-dependent
Application Information	Internal Bus Capacitance (μF)	2110	2110	2110
	VLOW (Regen Circuit Turn Off) (VDC)	380	380	380
	VMAX (Regen Circuit Turn On) (VDC)	400	400	400

\*Line to Line: L1 to L2, or L1 to L3 or L2 to L3

\*\*3-Phase only

**Table 3-4. Mechanical & Electrical Specifications – FLEXI PRO-020/FLEXI PRO-024 (120/240 VAC)**

Three-Phase 120-240 VAC	Specification	FLEXI PRO-020	FLEXI PRO-024
<b>Ratings</b>			
Input Power Circuit (L1, L2, L3)	Voltage (VAC Line-Line*) Nominal ±10%	120/240	120/240
	Line Frequency (Hz)	50/60	50/60
	120/240 VAC	3 Phase	3 Phase
	Continuous Current (3 ph A rms)	20@240V	24@240V
	Line Fuses (FRN-R, LPN, or equivalent) (A)	25	30
	Withstand Voltage (Primary to Earth)	1500 VAC (2121 VDC)	1500 VAC (2121 VDC)
Control Circuit Input Power (L1C, L2C)	120 or 240 VAC	1 Phase	1 Phase
Logic Input Fuse (Time Delay)	120 or 240 VAC (A)	0.5	0.5
STO (Safe Torque Off)	STO Power supply (VDC)	24 ±5%	24 ±5%
STO Fuse (Time Delay)	24 VDC ±10%	1.5	1.5

Three-Phase 120-240 VAC	Specification	FLEXI PRO- 020	FLEXI PRO- 024
Motor Output (U, V, W)	Continuous Output Current (A rms)	20	24
	Continuous Output Current (A peak)	28.28	34.93
	Peak Output Current (A rms) for 2 seconds	48	48
	Peak Output Current (A peak) for 2 seconds	67.88	67.88
	kVA at 120 VAC	3	3.5
	kVA at 240 VAC	5	6
	PWM Frequency (kHz)	8	8
Soft Start	Max. Surge Soft Start Current (A)	15	15
	Max. Charge Time (ms)	1000	1000
Power Circuit Loss	W		
Control Circuit Loss	W	5	5
Total Power Loss	W		
<b>Hardware</b>			
Unit Weight	kg	3.2	3.2
Connection Hardware	PE Ground Screw Size/Torque	M4/1.35 Nm	M4/1.35 Nm
Wire Size	Control Circuit (AWG) up to 3 meters	24-28	24-28
	Main Circuit Motor Lines (AWG)	12	12
	Main Circuit AC Inputs (AWG)	12	12
	PE Ground Screw	M4	M4
Clearance Distance	Side-to-Side (mm)	5	5
	Top/Bottom (mm)	50	50
<b>Voltage Trip</b>			
	Under-Voltage Trip (nominal) (VDC)	100	100
	Over-Voltage Trip (VDC)	420	420
<b>Power Temperature</b>			
Fan	Normally operates at quarter power; when temperature exceeds high-speed fan trigger temperature, operates at full power	Yes	Yes
	Power Module Over-Temperature Fault Regulated (°C)	80 ±5%	80 ±5%
	Power Module Over-Temperature Fault Non-regulated (°C)	100 ±5%	100 ±5%
	Power Module Over-Temperature Fault (°C)	100	100
	Trigger Temperature for High Speed Fan (°C)	45	45
<b>External Regenerative Resistor (B1+, B2)</b>			
External regenerative resistor requirement (regen resistor not supplied with drive)	Peak current (A)	44	44
	Minimum resistance (Ω)	8.4	8.4
	Power Rating (W)	System-dependent	System-dependent
Application Information	Internal Bus Capacitance (μF)	3280	3280
	VLOW (Regen Circuit Turn Off) (VDC)	380	380
	VMAX (Regen Circuit Turn On) (VDC)	400	400

\*Line to Line: L1 to L2, or L1 to L3 or L2 to L3

**Table 3-5. Mechanical & Electrical Specifications –  
FLEXI PRO-003/FLEXI PRO-006/FLEXI PRO-012 (400/480 VAC)**

Three Phase 400/480 VAC	Specification	FLEXI PRO- 003*	FLEXI PRO- 006*	FLEXI PRO- 012
<b>Ratings</b>				
Input Power Circuit (L1, L2)	Voltage (VAC Line-Line) Nominal $\pm 10\%$	380/480	380/480	380/480
	Line Frequency (Hz)	50/60	50/60	50/60
	380/480 VAC	3 Phase	3 Phase	3 Phase
	Continuous Current (3 ph A rms)	2.8@400V, 2.3@480V	5.7@400V , 4.6@480V	11.0@400V 9.2@480V
	Line Fuses (FRN-R, LPN, or equivalent) (A)	10	10	16
	Withstand Voltage (Primary to Earth)	1800 VAC (2520 VDC)	1800 VAC (2520 VDC)	1800 VAC (2520 VDC)
Control Circuit Input Power (P2)	24 VDC $\pm 10\%$	24 VDC $\pm 10\%$	24 VDC $\pm 10\%$	24 VDC $\pm 10\%$
STO (Safe Torque Off)	STO Power Supply (VDC)	24 $\pm 10\%$	24 $\pm 10\%$	24 $\pm 10\%$
Motor Output (U, V, W)	Continuous Output Current (A rms)	3.0	6.0	12.0
	Continuous Output Current (A peak)	4.24	8.48	16.97
	Peak Output Current (A rms) for 2 seconds	9	18	24
	Peak Output Current (A peak) for 2 seconds	12.72	25.45	33.84
	kVA at 380 VAC	1.63	3.11	6.22
	kVA at 480 VAC	1.77	3.68	7.36
	PWM Frequency (kHz)	8	8	8
Soft Start	Max. Surge Soft Start Current (A)	7	7	9
	Max. Charge Time (ms)	1300	1300	1300
Power Circuit Loss	W			
Control Circuit Loss	W	5	5	5
Total Power Loss	W			
<b>Hardware</b>				
Unit Weight	kg	2.1	2.1	3.2
Connection Hardware	PE Ground Screw Size/Torque	M4/1.35 Nm	M4/1.35 Nm	M4/1.35 Nm
Wire Size	Control Circuit (AWG) up to 3 meters	24-28	24-28	24-28
	Main Circuit Motor Lines (AWG)	12-14	12-14	12-14
	Main Circuit AC Inputs (AWG)	12-14	12-14	12-14
	PE Ground Screw	M4	M4	M4
Clearance Distance	Side-to-Side (mm)	25	25	25
	Top/Bottom (mm)	50	50	50
<b>Voltage Trip</b>				
	Under-Voltage Trip (Nominal) (VDC)	320	320	320
	Over-Voltage Trip (VDC)	800	800	800

Three Phase 400/480 VAC		Specification	FLEXI PRO- 003*	FLEXI PRO- 006*	FLEXI PRO- 012
<b>Power Temperature</b>					
Fan	Normally operates at quarter power; when temperature exceeds high-speed fan trigger temperature, operates at full power		Yes	Yes	Yes
	Power Module Over-Temperature Fault Regulated (°C)		76 ±5%	76 ±5%	76 ±5%
	Power Module Over-Temperature Fault Non-regulated (°C)		100 ±5%	100 ±5%	100 ±5%
	Trigger Temperature for High Speed Fan (°C)		40	40	40
<b>Regenerative Resistor</b>					
Internal regenerative resistor (B1+,B2)	Peak Current (A)		16.8	16.8	23.9
	Resistance (Ω)		33	33	22
External regenerative resistor (B1+, B2)	Peak Current (A)		16.8	16.8	23.9
	Minimum Resistance (Ω)		33	33	22
	Power Rating (W)		System-dependent	System-dependent	System-dependent
Application Information	Internal Bus Capacitance (μF)		410	410	820
	VLOW (Regen Circuit Turn Off) (VDC)		770	770	770
	VMAX (Regen Circuit Turn On) (VDC)		780	780	780
<b>Brake</b>					
	On State Voltage @ Rated Current (min) at 24 VDC Logic Power (VDC)		23.5	23.5	23.5
	Off State Leakage Current (mA)		<2	<2	<2
	Maximum Current Capability (A)		1.3A	1.3	1.3
	Short Circuit Protection		Yes	Yes	Yes
	Time to Open Maximum (ms)		20	20	20
	Time to Close Maximum (ms)		20	20	20

\* When using 480 VAC 3-phase FLEXI PRO-003/FLEXI PRO-006, make sure the motor inductance is higher than 4 mH L-L (line to line).

**Table 3-6. Mechanical & Electrical Specifications –  
FLEXI PRO-024/FLEXI PRO-030 (400/480 VAC)**

Three-Phase 400/480 VAC	Specification	FLEXI PRO- 024	FLEXI PRO- 030
<b>Ratings</b>			
Input Power Circuit (L1, L2, L3)	Voltage (VAC Line-Line) Nominal $\pm 10\%$	380/480	380/480
	Line Frequency (Hz)	50/60	50/60
	380/480 VAC	3 Phase	3 Phase
	Continuous Current (3 ph A rms)	24	30
	Line Fuses (FRN-R, LPN, or equivalent) (A)	30	35
	Withstand Voltage (Primary to Earth)	1800 VAC (2520 VDC)	1800 VAC (2520 VDC)
Control Circuit Input Power (P2)	24 VDC $\pm 10\%$	24 VDC $\pm 10\%$	24 VDC $\pm 10\%$
STO and STO2 (Safe Torque Off)	STO Power supply (VDC)	24 $\pm 10\%$	24 $\pm 10\%$
STO Fuse (Time Delay)	24 VDC $\pm 10\%$	1.5	1.5
Motor Output (U, V, W)	Continuous Output Current (A rms)	24	30
	Continuous Output Current (A peak)	33.94	42.3
	Peak Output Current (A rms) for 3 seconds	72	90
	Max Peak Output Current (A peak) for 2 seconds	102	126
	kVA at 380 VAC	12.2	15.1
	kVA at 480 VAC	15.4	19.0
	PWM Frequency (kHz)	8	8
Soft Start	Max. Surge Soft Start Current (A)	10	10
	Max. Charge Time (ms)	1500	1500
Power Circuit Loss	W		
Control Circuit Loss	W	5	5
Total Power Loss	W		
<b>Hardware</b>			
Unit Weight	kg	10.5	10.5
Connection Hardware	PE Ground Screw Size/Torque	M4/1.35 Nm	M4/1.35 Nm
Wire Size	Control Circuit (AWG) up to 3 meters	24-28	24-28
	Main Circuit Motor Lines (AWG)	12	10
	Main Circuit AC Inputs (AWG)	12	10
	PE Ground Screw	M4	M4
Clearance Distance	Side-to-Side (mm)	30	30
	Top/Bottom (mm)	50	50
<b>Voltage Trip</b>			
	Under-Voltage Trip (nominal) (VDC)	320	320
	Over-Voltage Trip (VDC)	800	800

Three-Phase 400/480 VAC	Specification	FLEXI PRO- 024	FLEXI PRO- 030
<b>Power Temperature</b>			
Fans	Operates at full power	Yes	Yes
	Power Module Over-Temperature Fault Regulated (°C)	80 ±5%	80 ±5%
	Power Module Over-Temperature Fault Non-regulated (°C)	100 ±5%	100 ±5%
	Trigger Temperature for High Speed Fan (°C)	NA	NA
<b>Regenerative Resistor</b>			
Internal regenerative resistor (optional)	Peak Current (A)	65	65
	Resistance (Ω)	12	12
	Power Rating (W)	300	300
External regenerative resistor	Peak current (A)	100	100
	Minimum resistance (Ω)	8.4	8.4
	Power Rating (W)	System-dependent	System-dependent
Application Information	Internal Bus Capacitance (μF)	3280	3280
	VLOW (Regen Circuit Turn Off) (VDC)	770	770
	VMAX (Regen Circuit Turn On) (VDC)	780	780
<b>Brake</b>			
	On State Voltage @ Rated Current (min) at 24 VDC Logic Power (VDC)	23.5	23.5
	Off State Leakage Current (mA)	<2	<2
	Maximum Current Capability (A)	<2	<2
	Short Circuit Protection	Yes	Yes
	Time to Open Maximum (ms)	20	20
	Time to Close Maximum (ms)	20	20

### 3.3 Control Specifications

**Table 3-7. Control Specifications – Interface Options: Analog Voltage/Pulse Train, CANopen, USB, RS232**

Feature	Specification	
Motors	DC Brushless, DC Brush	Rotary servomotors, Linear servomotors
	Auto-configuration	Automatic self-configuration of motor phasing and wire settings
Operation Mode	Selectable Modes	Current (Torque) Control, Velocity Control, Position Control, HD Control
Current (Torque) Control	Input/Output	Current command / 3 phase PWM command
	Performance	Update rate 31.25 μs (32 kHz), Output waveform sinusoidal
	Step Response Time	Actual current reaches command in two cycles, 62.5 μs
	Control Loop	DQ, PI, Feed-forward
	Reference Command	Analog Voltage ±10 VDC, Serial RS232 or USB*, CANopen*
Autotuning		Automatic self-tuning of current control loop parameters



Feature	Specification	
Velocity Control	Input/Output	Velocity command / Current command
	Performance	Update rate 125 $\mu$ s (8 kHz)
	Selectable Velocity Control Loops	PI , PDFF, Standard pole placement, Advance pole placement, Standard pole placement high frequency, Pole placement with active dumping
	Filters	First order low pass filter, Double first order low pass filter, Notch, High pass filter, Band pass filter, User defined polynomial filter
	Reference Command	Analog Voltage $\pm$ 10 VDC, Serial RS232 or USB*, CANopen*
Position Control	Input/Output	Position command / Velocity command
	Performance	Update rate 250 $\mu$ s (4 kHz)
	Control loop	PID and feed-forward
	Reference Command	Pulse and direction with electronic gearing, Serial, Serial RS232 or USB*, CANopen*
HD Control	Input/Output	Position command or Velocity command/Current command
	Performance	Update rate 250 $\mu$ s (4 kHz)
	Control Loop	Nonlinear control algorithm provides very low tracking error, zero or minimum settling time and smooth movement; includes an adaptive feed-forward feature that is applied at end of movement to achieve zero or minimum settling time.
	Filters	One second order low pass, two notch filters, and other filters to handle flexible and resonant systems
	Reference Command	Velocity: Analog Voltage $\pm$ 10 VDC, Serial RS232 or USB*, CANopen* Position: Pulse and direction with electronic gearing, Serial, Serial RS232 or USB*, CANopen*
	Auto tuning	Automatic inertia load measurement, self-tuning and optimization of HD control loop parameters. Optimal settling time up to 0-2 ms
Brake	Method	Control stops: Several Dynamic brake and Active disable options
Display	Method	7-segment LED (green), display drive status
Electronic Gearing	Method	User define input signal ratio
GUI	User Interface	Flexi SUITE Windows-based application
	Function	Setting connection, Drive information, Power information, Motor, Feedback, I/O selection/configuration, Motion setting/tuning, Fault history/display, Setup wizard, Expert view
Rotary Units	Position	Revolutions, counts, degrees
	Velocity	rps, rpm, deg/s
	Acceleration/Deceleration	rps/s, rpm/s, deg/s <sup>2</sup>
Linear Units	Position	Counts, pitch, mm, $\mu$ m
	Velocity	mm/s, $\mu$ m/s
	Acceleration/Deceleration	mm/s <sup>2</sup> , $\mu$ m <sup>2</sup> /s

\* Some features are not available on all models. Check the options in the section *Ordering Information*, or contact your supplier.

## 3.4 Protective Functions and Environmental Specifications

**Table 3-8. Protective Functions and Environmental Specs – All FLEXI PRO Models**

Feature	Specification
Protective Functions	Partial list, Under- and over-voltage, Over-current, Drive and motor over-temperature, Motor foldback, Drive foldback, Feedback lost, Secondary feedback lost, STO signal not connected, Not configured, Circuit failure, Motor phases disconnected
Compliance	IEC 61800-5-1: Low Voltage Directive 2006/95/EC. Adjustable speed electrical power drive systems.
	IEC 61800-3: EMC Directive 2004/108/E. Adjustable speed electrical power drive systems.
	EN 50581: Support Essential Requirements of EU RoHS Directive 2011/65/EU. Directive on the restriction of the use of certain hazardous substances in electrical and electronic equipment.
	UL 508C: TÜV Rheinland certification. Power Conversion Equipment.
	REACH: EC Regulation 1907/2006. Regulation on chemicals and their safe use.
	<b>Note:</b> CE and UL certification is pending for FLEXI PRO-024/FLEXI PRO-030 (400/480 VAC) models; they are currently undergoing testing.
Environment	Ambient temperature: Operation 0-45°C, Storage 0-70°C
	Humidity: 10-90%
	Altitude: If in accordance with specified clearances, per IEC 61800-5-1, the FLEXI PRO is rated for use at altitudes up to 2000m
	Vibration: 1.0g
Protection class/ Pollution degree	Protection class: IP20, pollution degree: 2 as per IEC 60664-1 Do not use in the following locations: corrosive or flammable gasses, water oil or chemical, dust including iron dust and salts
Configuration	Book mounting

## 3.5 Communication Specifications

**Table 3-9. Communication Specifications**

Feature	Specification
CANopen*	CANopen – CiA 301 application layer and CiA 402 device profile for drives and motion control
	Baud rate 0.5M 1M bit/s
EtherCAT*	CiA 301 application layer and CiA 402 device profile for drives and motion control
	Communication cycle time: up to 250 µs
RS232	ASCII-based, Flexi SUITE, HyperTerminal
	Baud rate 115200 bit/s
	Maximum cable length 10 m
USB*	ASCII-based, Flexi SUITE, HyperTerminal
	Baud rate 115200 bit/s
	Maximum cable length 3 m
Daisy Chain	Up to 8 axes. Axis address setting from 0-99 using two rotary switches.
	Maximum cable length 10 m

\* Some features are not available on all models. Check the options in the section *Ordering Information*,

or contact your supplier.

## 3.6 I/O Specifications

**Table 3-10 I/O Specifications**

Feature	Specification			
First Analog Input	Voltage Range	Analog $\pm 10$ VDC differential		
	Input Resolution	16 bit (14-bit on version with two analog inputs)		
	Input Impedance	8 k $\Omega$ (when using two analog inputs 20k $\Omega$ .)		
	Zero attenuation	200 Hz		
	Band width (-3 db)	1 KHz		
Second Analog Input*	Voltage Range	Analog $\pm 10$ VDC differential 14 bit		
	Input Resolution	14 bit		
	Input Impedance	20 k $\Omega$		
	Zero attenuation	200 Hz		
	Band width (-3 db)	1 KHz		
Pulse & Direction	Signal	RS 422 Line receiver		
	Max Input Frequency	4 MHz		
Equivalent Encoder Output	Signal	A-quad-B and index differential, RS422 line transmitter		
	Max Output Frequency	4 MHz		
	<b>FLEXI PRO Model</b>	<b>AP/AF</b>	<b>EC</b>	<b>EB</b>
<b>Digital Inputs</b>	Quantity	<b>8</b>	<b>8</b>	<b>4</b>
	Signal	Configurable. Opto-isolated. Compatible with sinking output.	Configurable. Opto-isolated. Compatible with sinking/sourcing supply.	Configurable. Opto-isolated. Compatible with sinking/sourcing supply.
	Voltage Operational Range	12V – 24V	12V – 24V	12V – 24V
	Max. Input Current	10 mA	10 mA	10 mA
	Propagation Delay Time	1 ms	1 ms	1 ms
<b>Fast Digital Inputs</b>	Quantity	<b>3</b>	<b>3</b>	<b>1</b>
	Signal	Configurable. Opto-isolated. Compatible with sinking output.	Configurable. Opto-isolated. Compatible with sinking/sourcing supply.	Configurable. Opto-isolated. Compatible with sinking/sourcing supply.
	Voltage	24 V	24 V	24 V
	Max. Input Current	10 mA	10 mA	10 mA
	Propagation Delay Time	1 $\mu$ s	1 $\mu$ s	1 $\mu$ s

Feature	Specification			
	FLEXI PRO Model	AP/AF	EC	EB
<b>Digital Outputs</b>	Quantity	<b>4</b>	<b>6</b>	<b>3</b>
	Signal	Configurable. Opto-isolated. Open collector. Sinking output.	Configurable. Opto-isolated. Open collector. Compatible with sinking/sourcing supply.	Configurable. Opto-isolated. Open collector. Compatible with sinking/sourcing supply.
	Voltage	24 V	24 V	24 V
	Max. Output Current	40 mA	40 mA	40 mA
	Propagation Delay Time	1 ms	1 ms	1 ms
<b>Fast Digital Outputs</b>	Quantity	<b>2</b>	–	–
	Signal	Configurable. Opto-isolated. Open collector. Sinking output.	–	–
	Voltage	24 V	–	–
	Max. Output Current	10 mA	–	–
	Propagation Delay Time	1 $\mu$ s	–	–
Analog Output	Signal	Configurable analog output		–
	Voltage Range	$\pm 10$ V		–
	Resolution	8 bit		–
	Low pass filter	2 KHz		–
	Max. Load	100 k $\Omega$		–
Secondary Feedback	Signal	A-quad-B and index differential, RS 422 line receiver		–
	Max. Input frequency	4 MHz (before A-quad-B)		–
	Min Index pulse width	1 $\mu$ s		–
	Functions	Dual loop, Master/Slave or Handwheel		–
Fault Output Relay	Signal	Configurable dry contacts		–
	Voltage	24V		–
	Max. Current	1 A		–

\* Some features are not available on all models. Check the options in the section *Ordering Information*, or contact your supplier.

### 3.7 Motor Feedback Specifications

**Table 3-11. Motor Feedback Specifications – All FLEXI PRO Models**

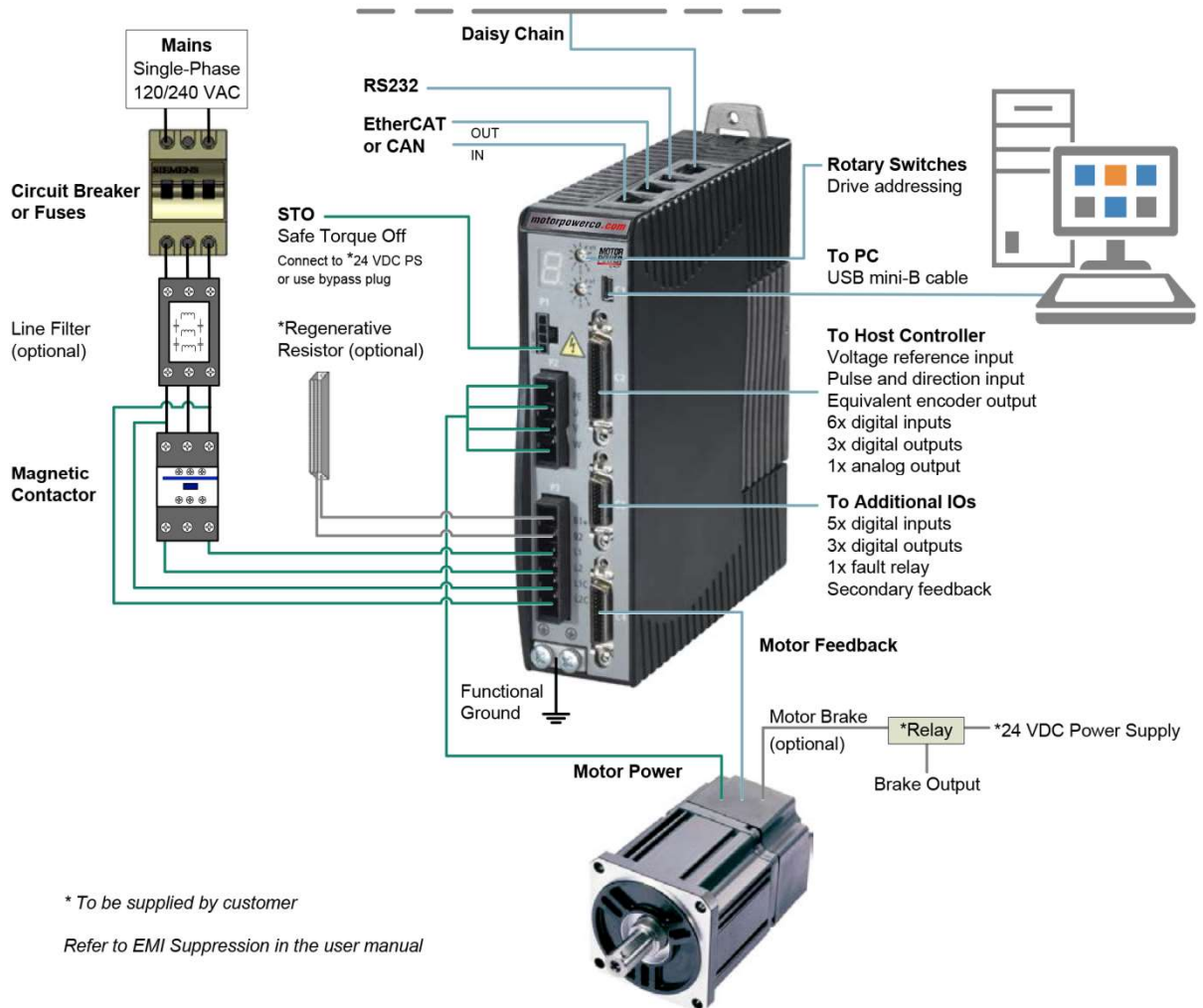
Motor Feedback	Specification	
General	Supply Voltage from Drive	5 VDC (7 VDC*)
	Max. Supply Current from Drive	250 mA @5V 140 mA @7V
	Max. Cable Length	AWG 28 – 3 m AWG 24 – 10 m
Incremental Encoder	Signal	A-quad-B with or without index/Halls, 8-channel Tamagawa, RS422 or RS485 line receiver, Differential
	A-quad-B Max Input Frequency	4 MHz (before quadrature)
	Min Index Pulse Width	1 $\mu$ s
Hall Sensor	Signal	Open collector single-ended (optional differential-ended)
Resolver	Signal	Sine/cosine differential
	Transformation Ratio	0.45 – 0.8
	Excitation Frequency	8 kHz
	Input Voltage from Drive	6-22 Vpp
	Max. DC Resistance	120 $\Omega$ (stator)
	Max. Drive Current	55 mA rms
	Output Voltage to Drive	10 Vpp
Sine Encoder	Signal	Sine/Cosine differential, with or without Halls
	Signal Level	1 Vpp @ 2.5 V
	Max. Input Frequency	100 kHz
	Protocols	EnDat 2.1, HIPERFACE
	Input Impedance	120 $\Omega$
	Interpolation	Up to 65536 (16 bit)
	Effective Interpolation	Up to 16384 (14 bit)
Serial Encoder	Signal	Differential data and clock for synchronous encoders Data only for asynchronous encoders
	Protocols	Can be supported upon request: EnDat 2.2, BiSS-C, other SSI
Motor Temperature	Signal	Thermal resistor PTC or NTC, User-defined fault threshold

\* Some features are not available on all models. Check the options in the section *Ordering Information*, or contact your supplier.

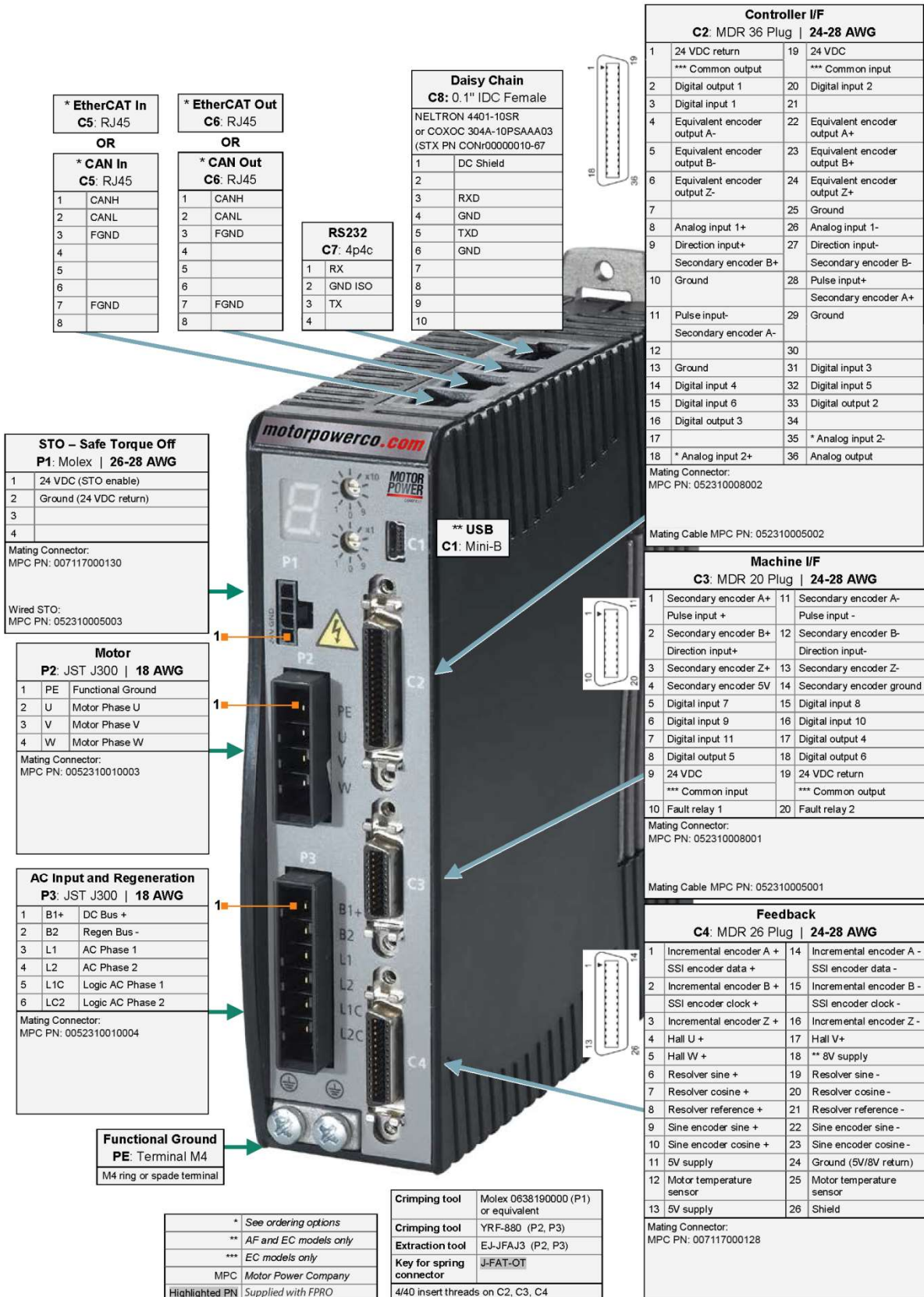


# 4 Wiring

## 4.1 FLEXI PRO-1D5/FLEXI PRO-003 (120/240 VAC) Wiring and Pin Assignments

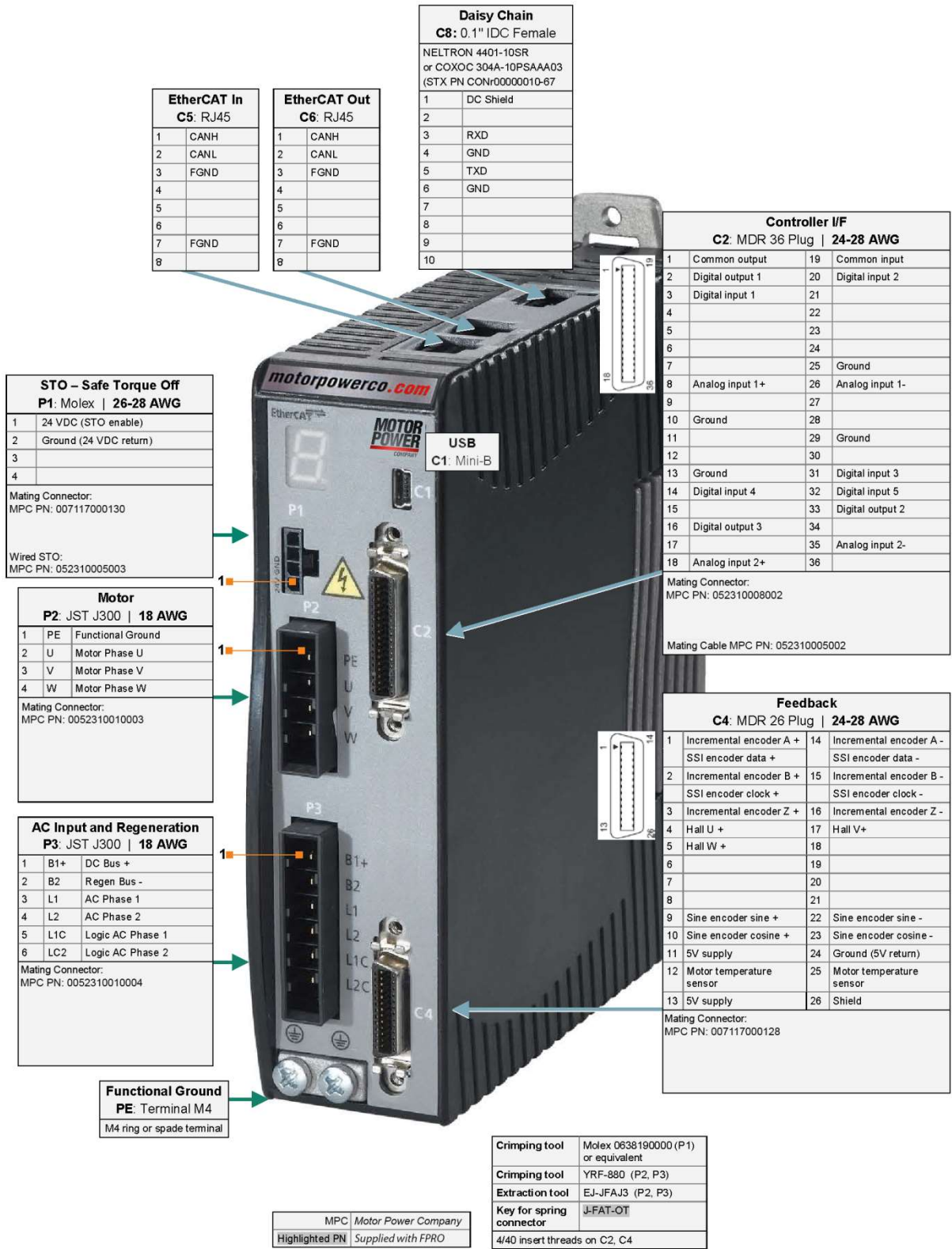


**Figure 4-1. Servo System Wiring, 1-Phase – FLEXI PRO-1D5/FLEXI PRO-003 (120/240 VAC)**



**Figure 4-2. Pin Assignments on FLEXI PRO-1D5/FLEXI PRO-003 – AP/AF/EC Models (120/240 VAC)**



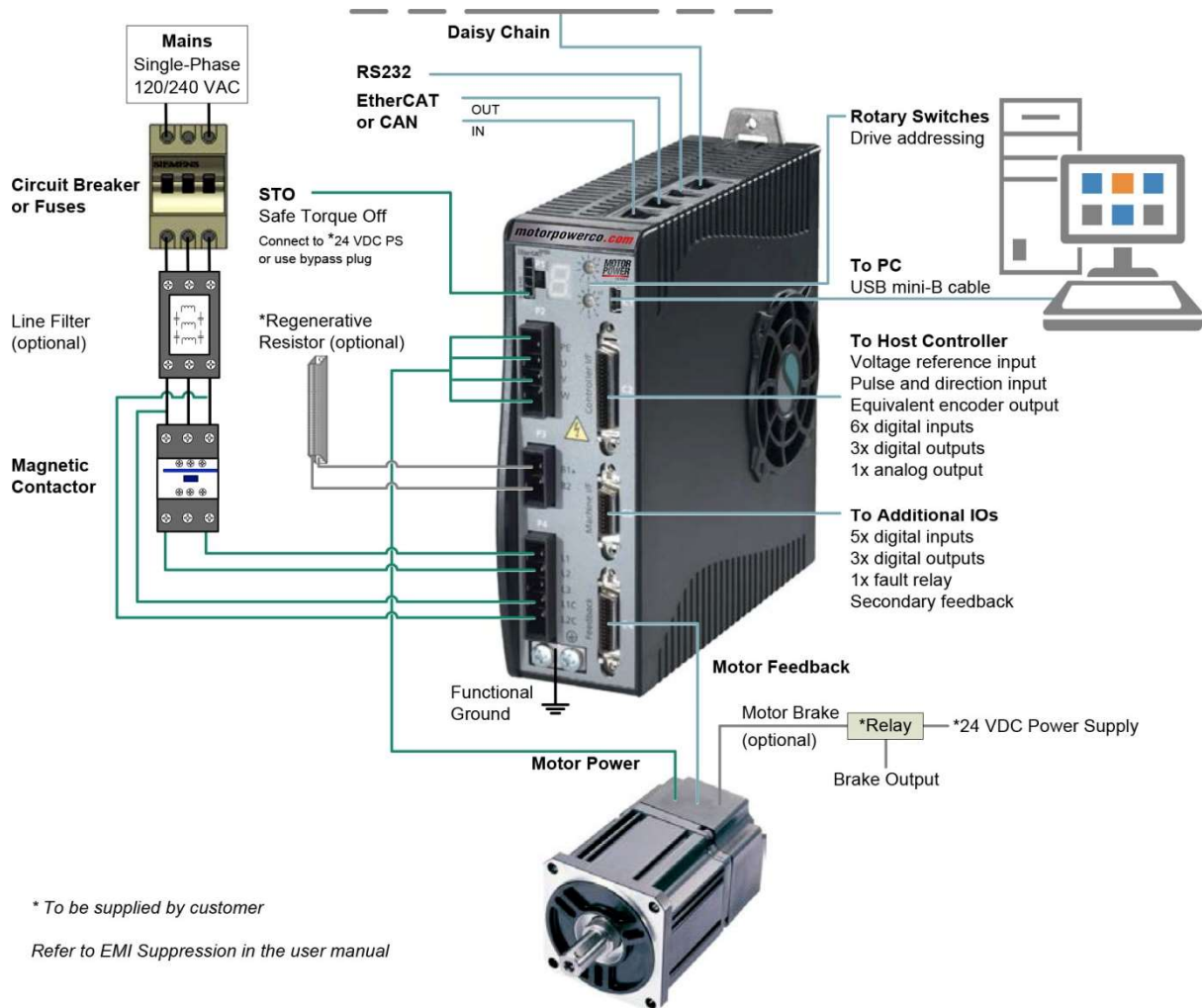


**Figure 4-3. Pin Assignments on FLEXI PRO-1D5/FLEXI PRO-003 – EB Models (120/240 VAC)**



**Figure 4-4. Pin Assignments on FLEXI PRO-1D5/FLEXI PRO-003 – PB Models (120/240 VAC)**

## 4.2 FLEXI PRO-4D5/FLEXI PRO-006 (120/240 VAC) Wiring and Pin Assignments



**Figure 4-5. Servo System Wiring, 1-Phase – FLEXI PRO-4D5/FLEXI PRO-006 (120/240 VAC)**

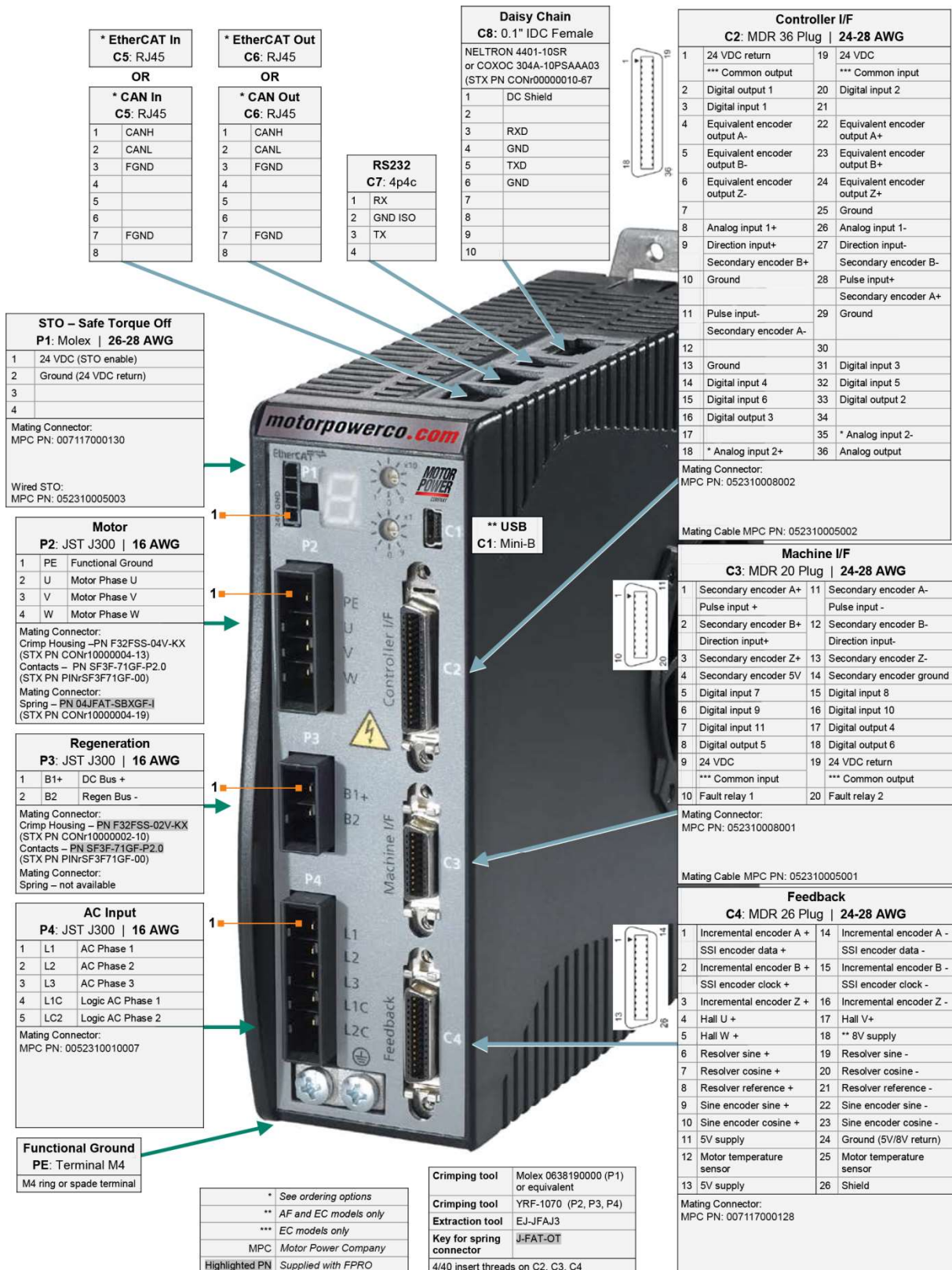
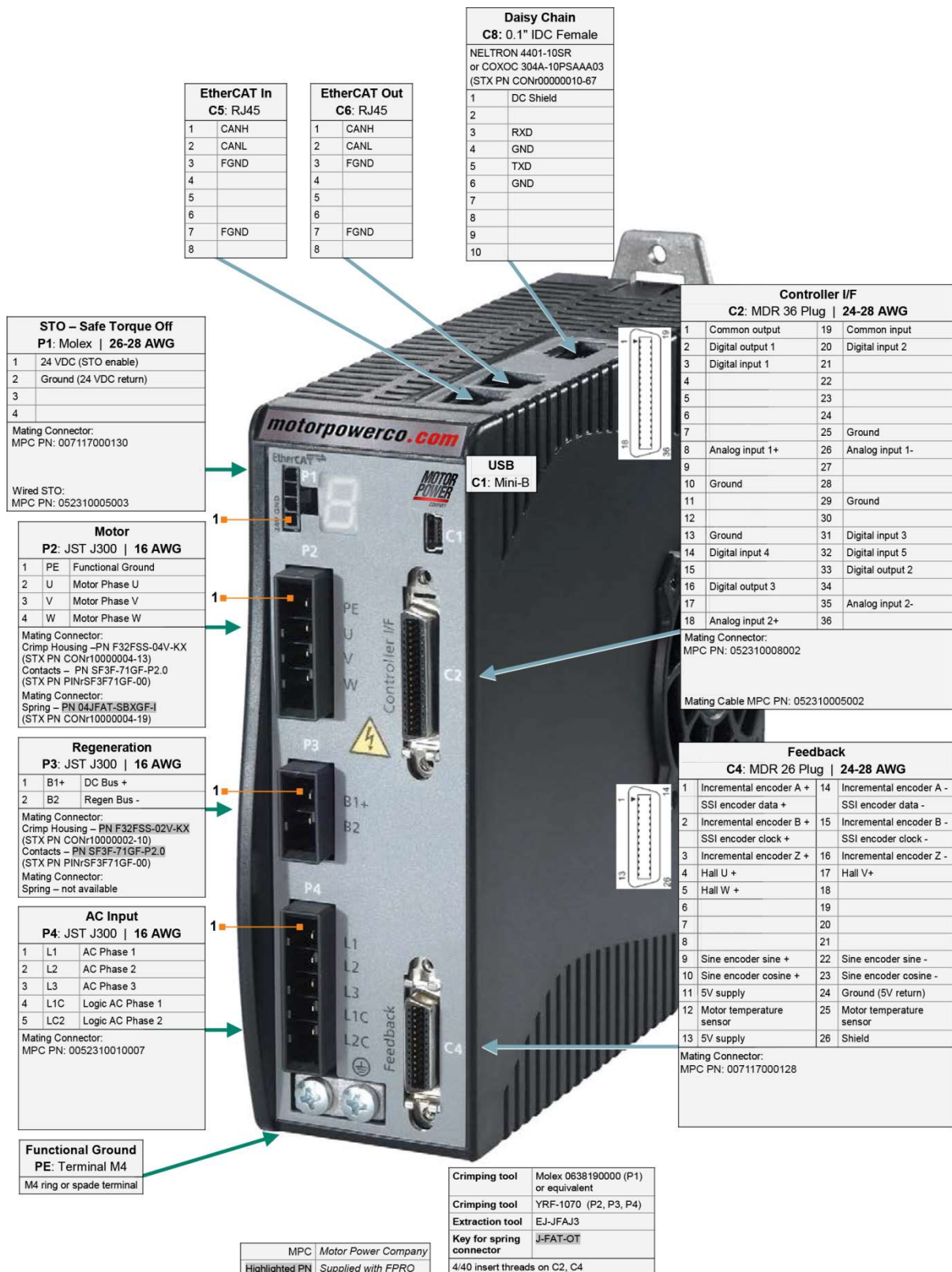
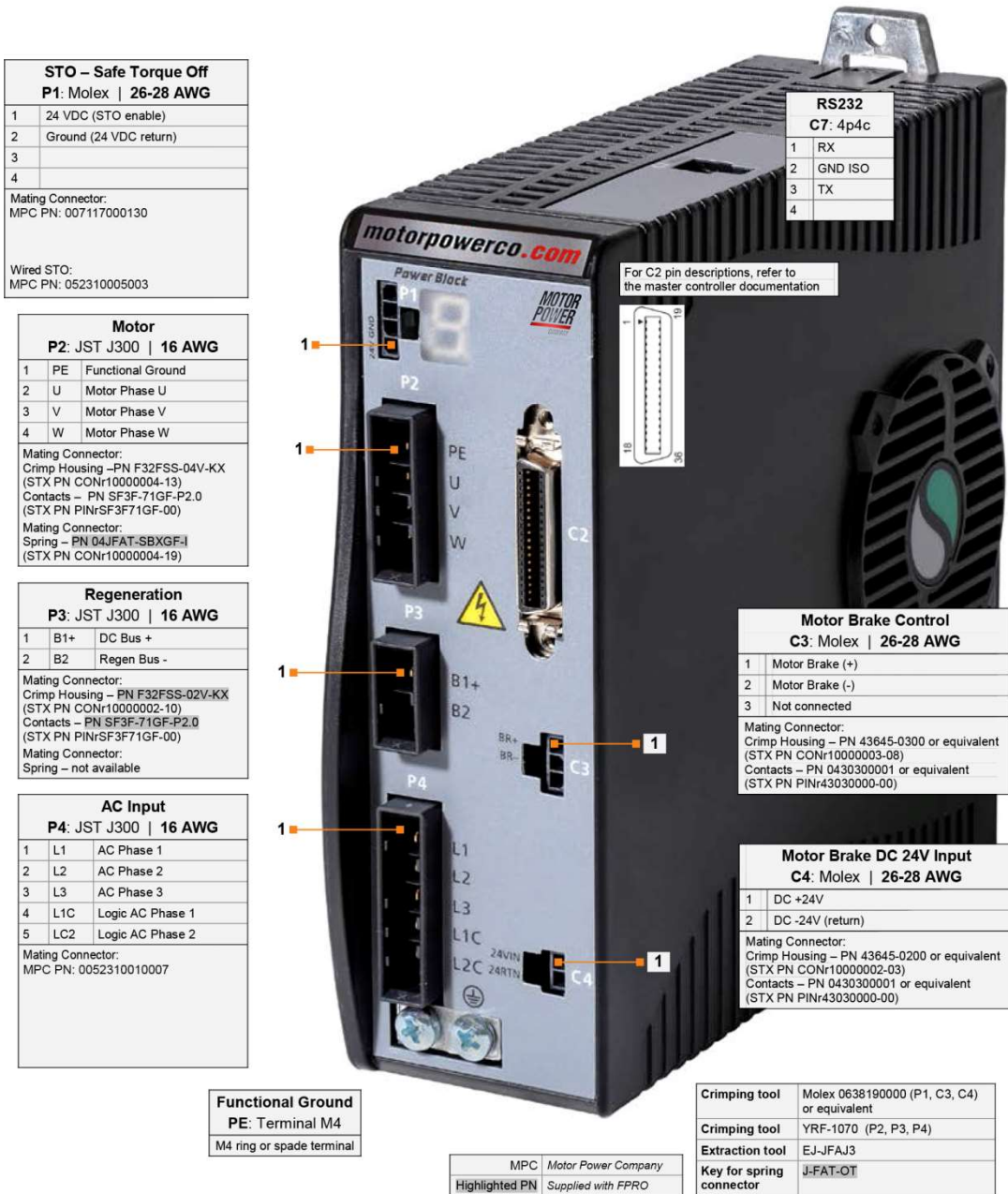


Figure 4-6. Pin Assignments on FLEXI PRO-4D5/FLEXI PRO-006 – AP/AF/EC Models (120/240 VAC)

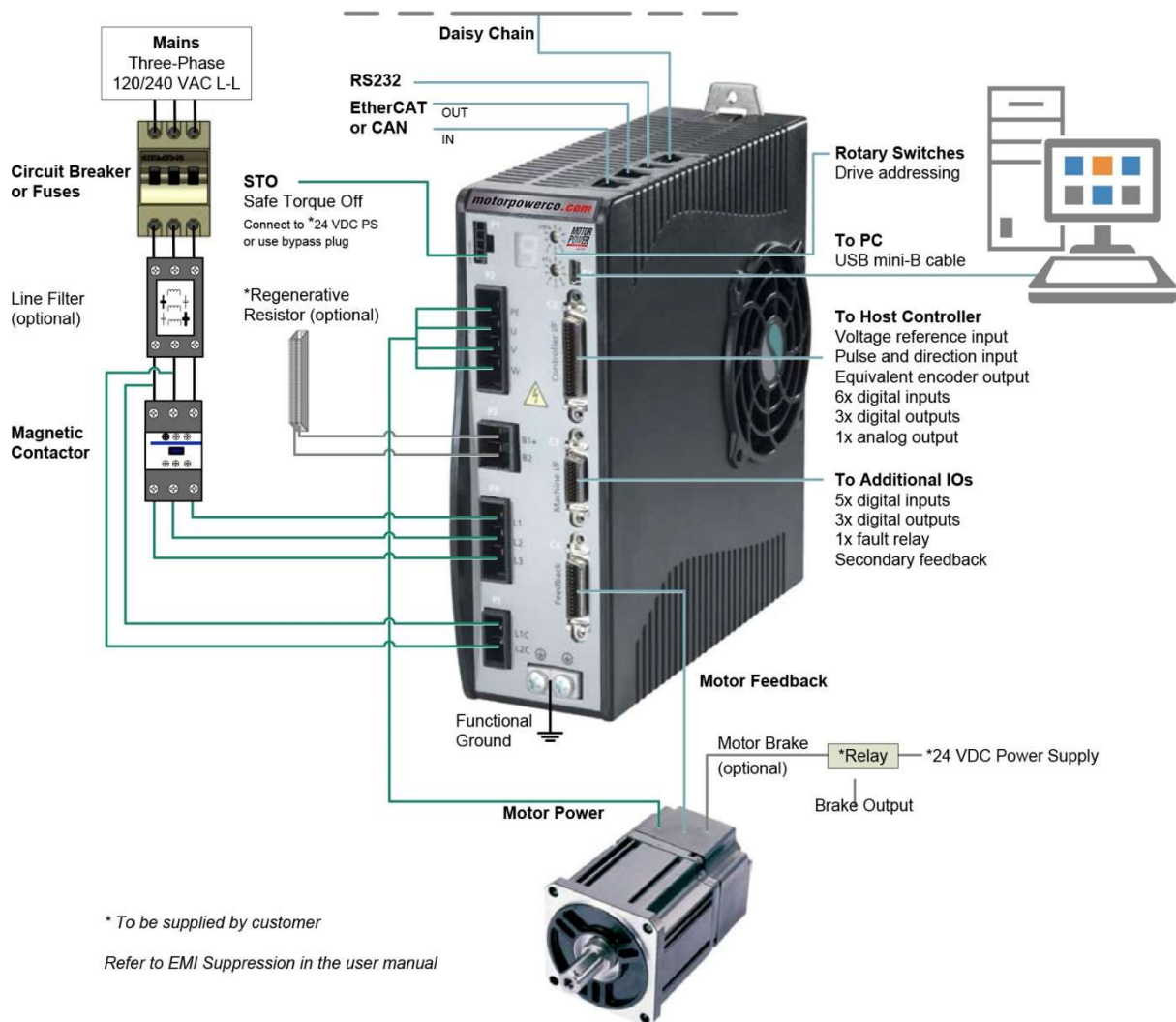


**Figure 4-7. Pin Assignments on FLEXI PRO-4D5/FLEXI PRO-006 – EB Models (120/240 VAC)**



**Figure 4-8. Pin Assignments on FLEXI PRO-4D5/FLEXI PRO-006 – PB Models (120/240 VAC)**

### 4.3 FLEXI PRO-008/FLEXI PRO-010/FLEXI PRO-013 (120/240 VAC) Wiring and Pin Assignments



**Figure 4-9. Servo System Wiring, 3-Phase – FLEXI PRO-008/FLEXI PRO-010/FLEXI PRO-013 (120/240 VAC)**

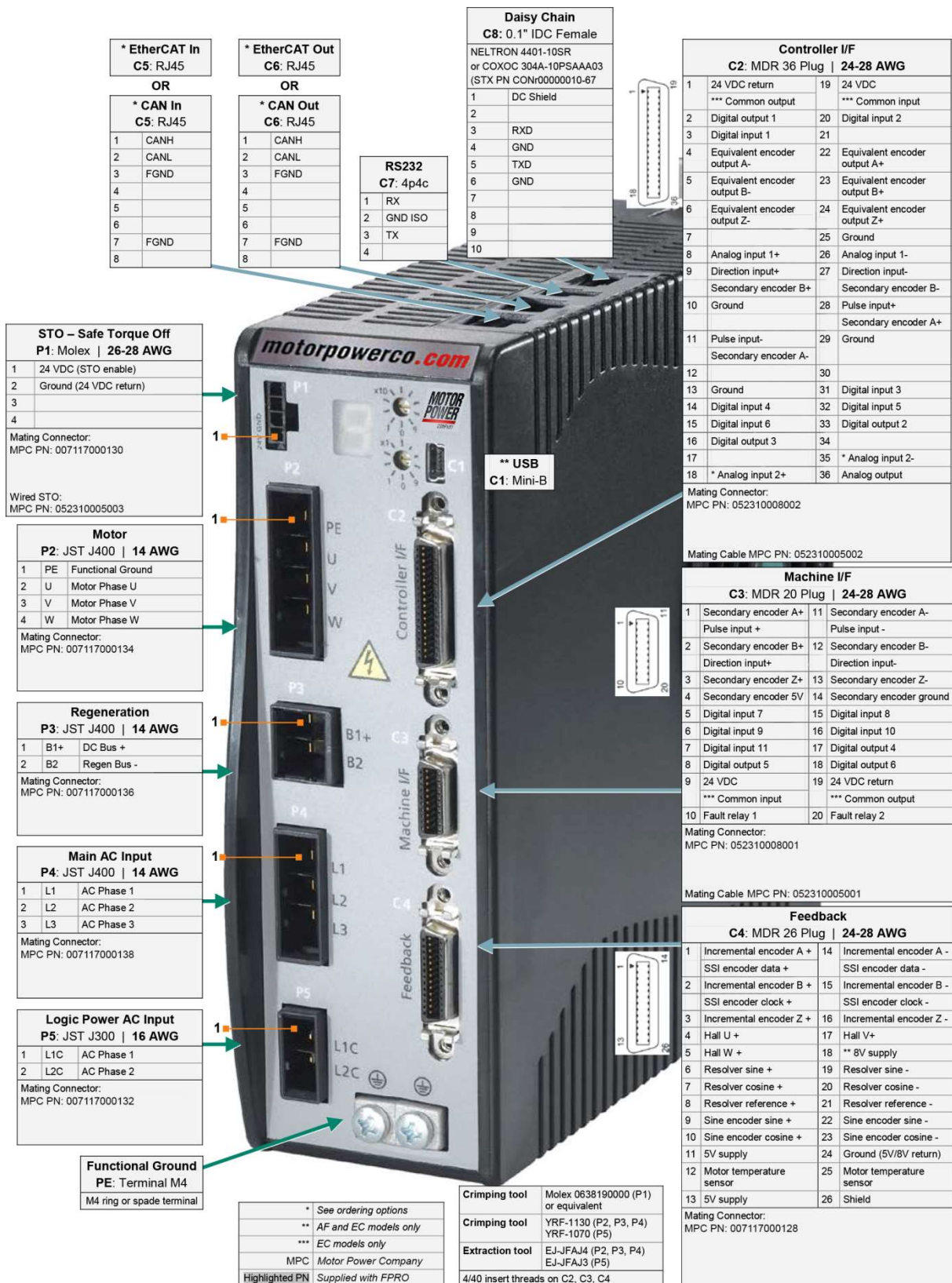
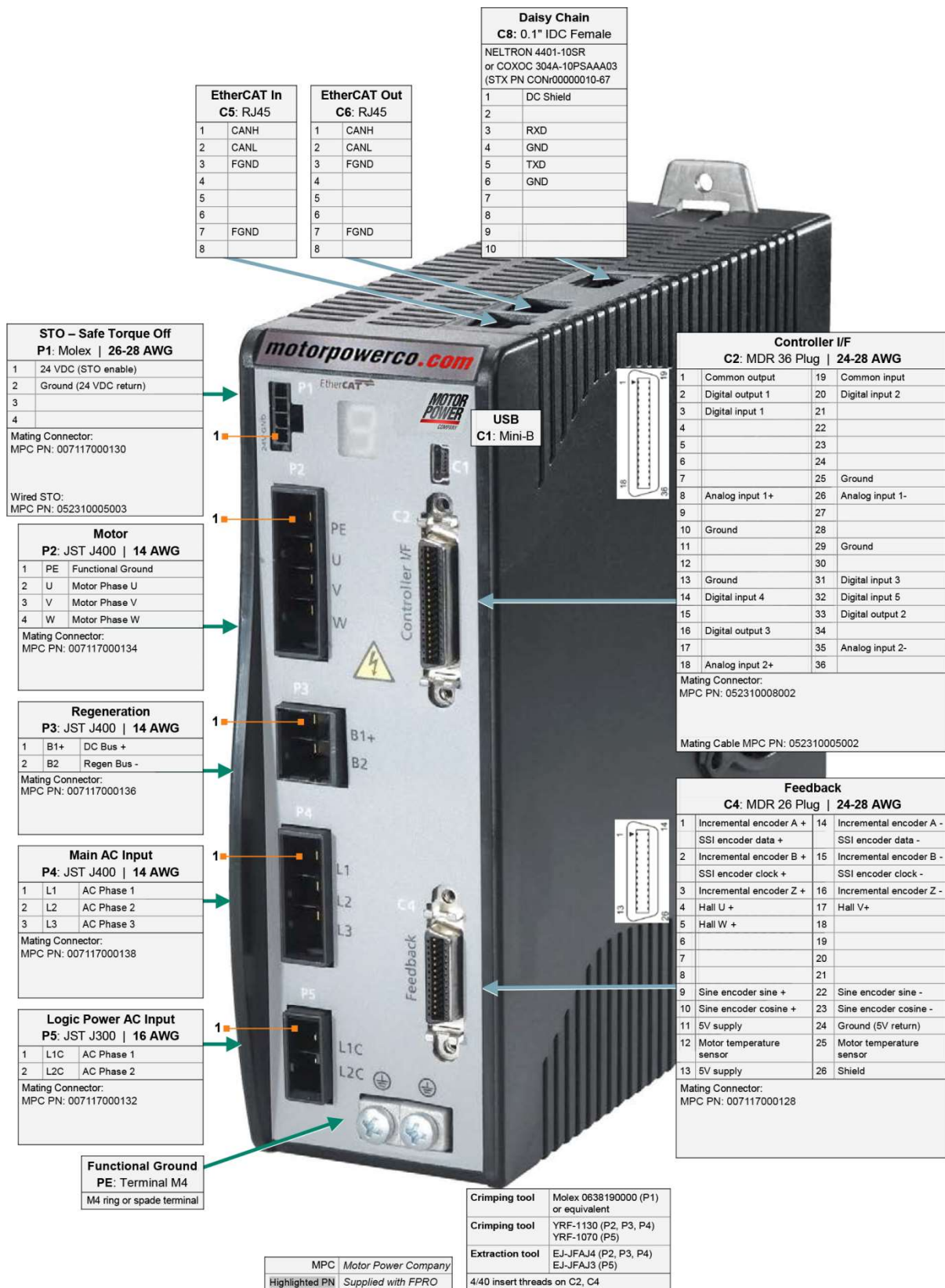
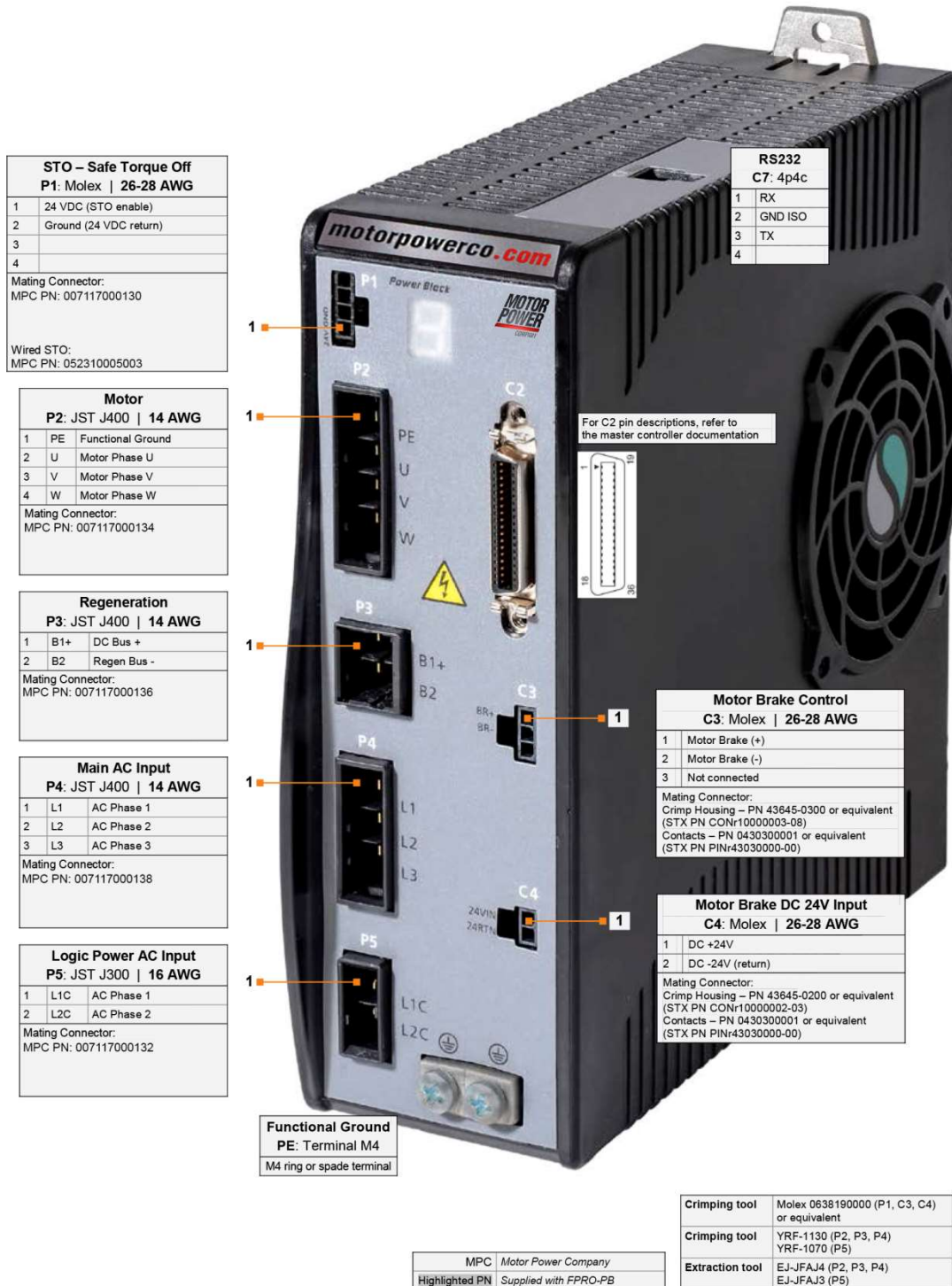


Figure 4-10. Pin Assignments on FLEXI PRO-008/FLEXI PRO-010/FLEXI PRO-013 – AP/AF/EC Models (120/240 VAC)



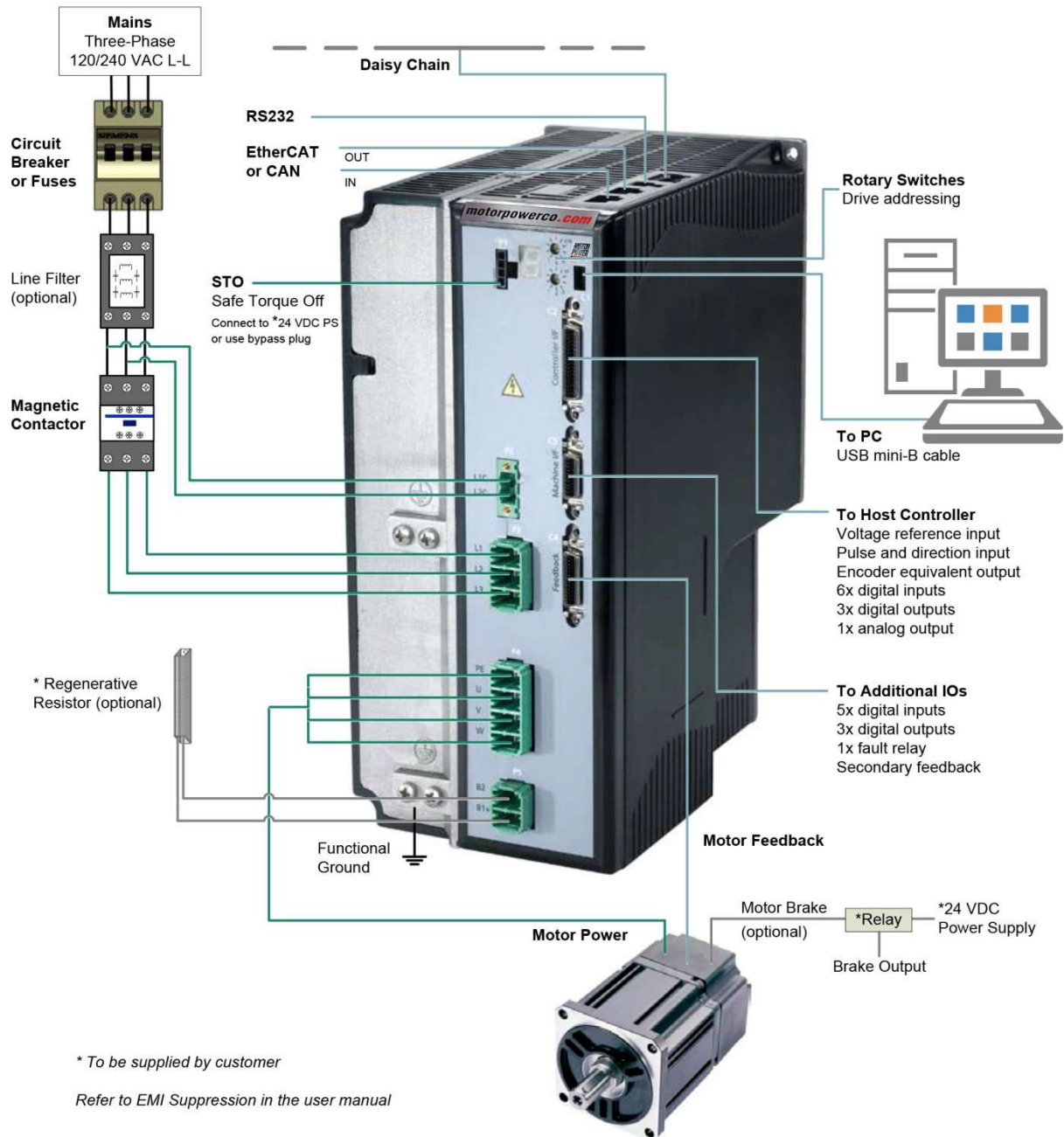


**Figure 4-11. Pin Assignments on FLEXI PRO-008/FLEXI PRO-010/FLEXI PRO-013 –EB Models (120/240 VAC)**



**Figure 4-12. Pin Assignments on FLEXI PRO-008/FLEXI PRO-010/FLEXI PRO-013 –PB Models (120/240 VAC)**

## 4.4 FLEXI PRO-020/FLEXI PRO-024 (120/240 VAC) Wiring and Pin Assignments



**Figure 4-13. Servo System Wiring, 3-Phase – FLEXI PRO-020/FLEXI PRO-024 (120/240 VAC)**

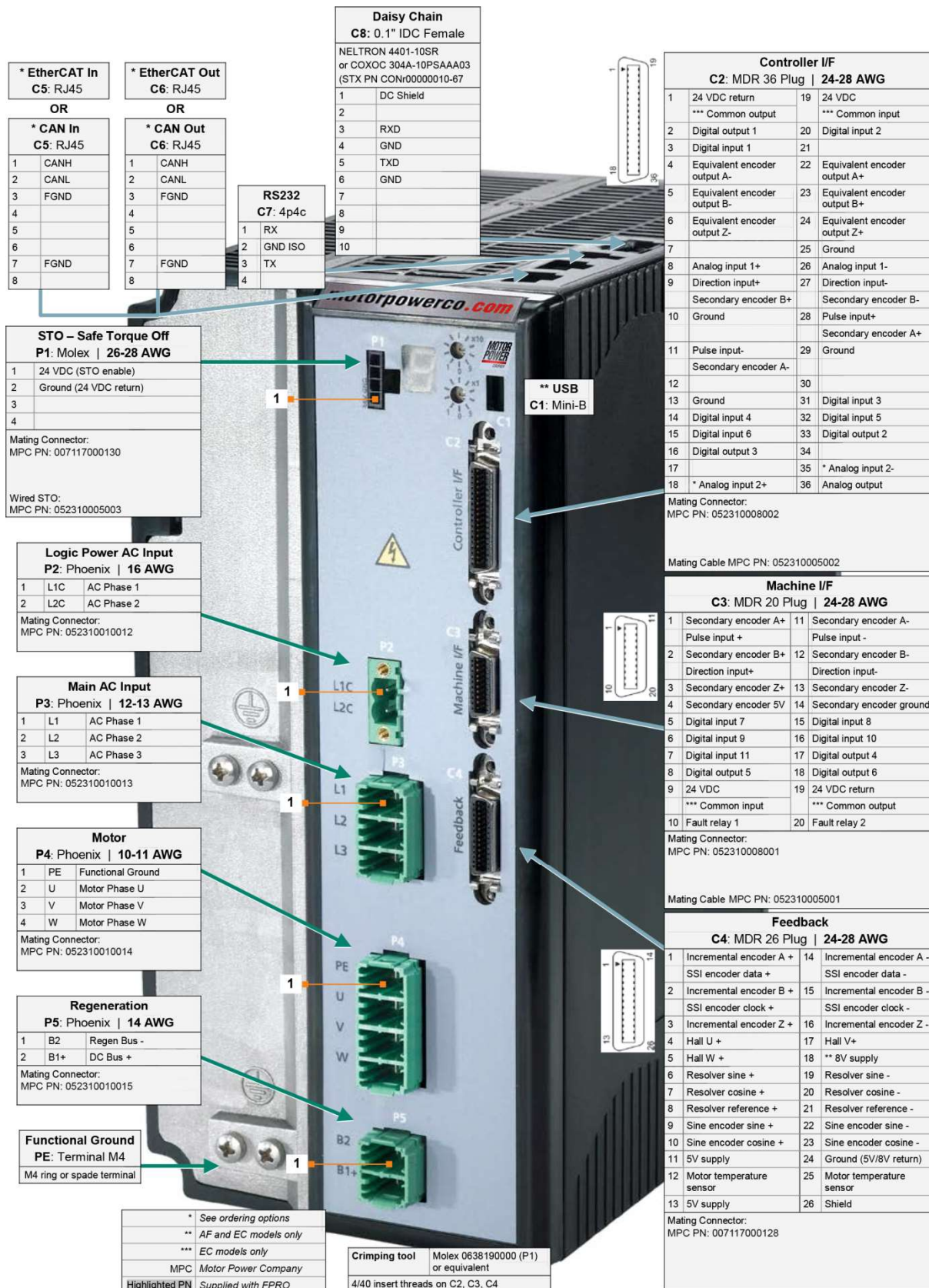
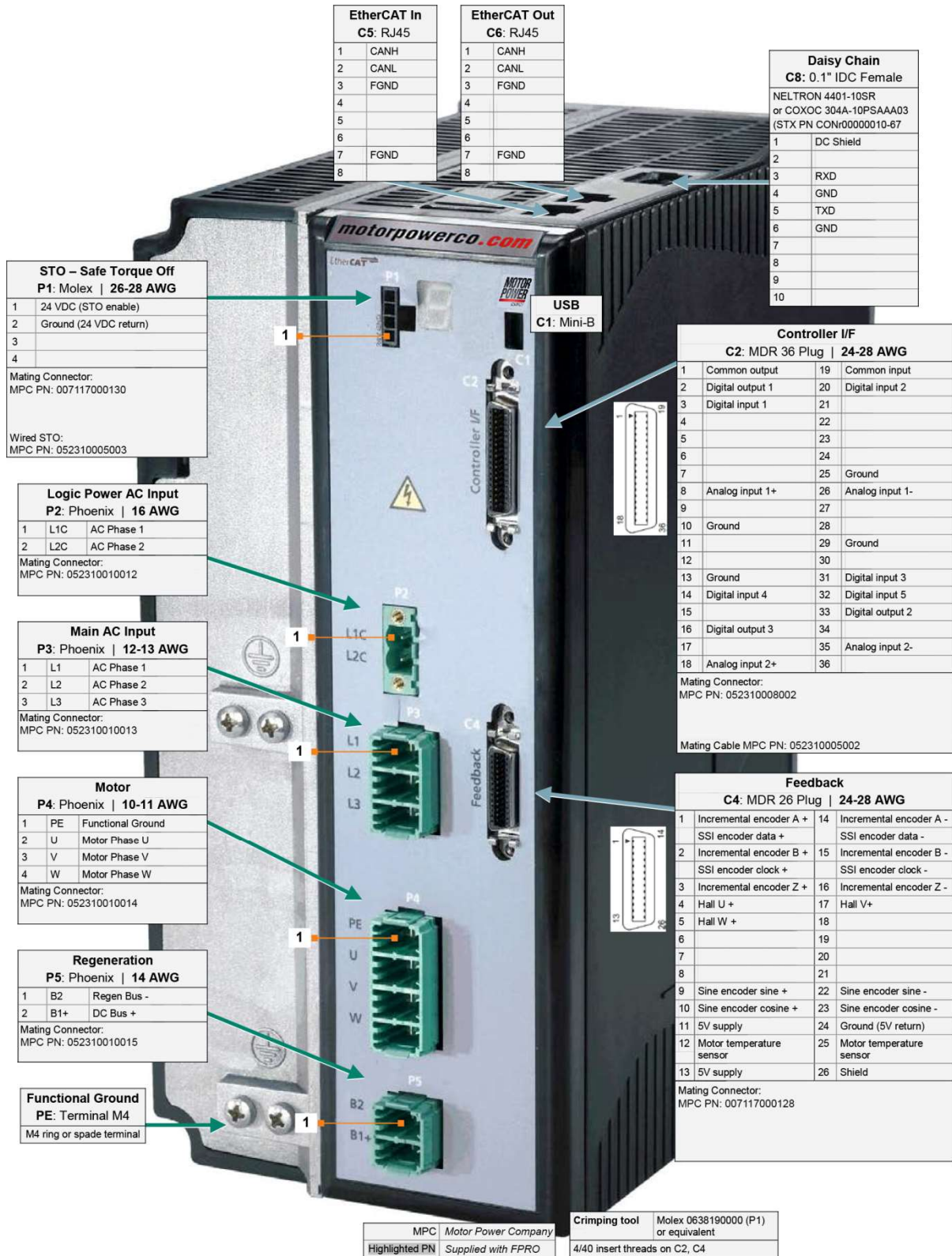
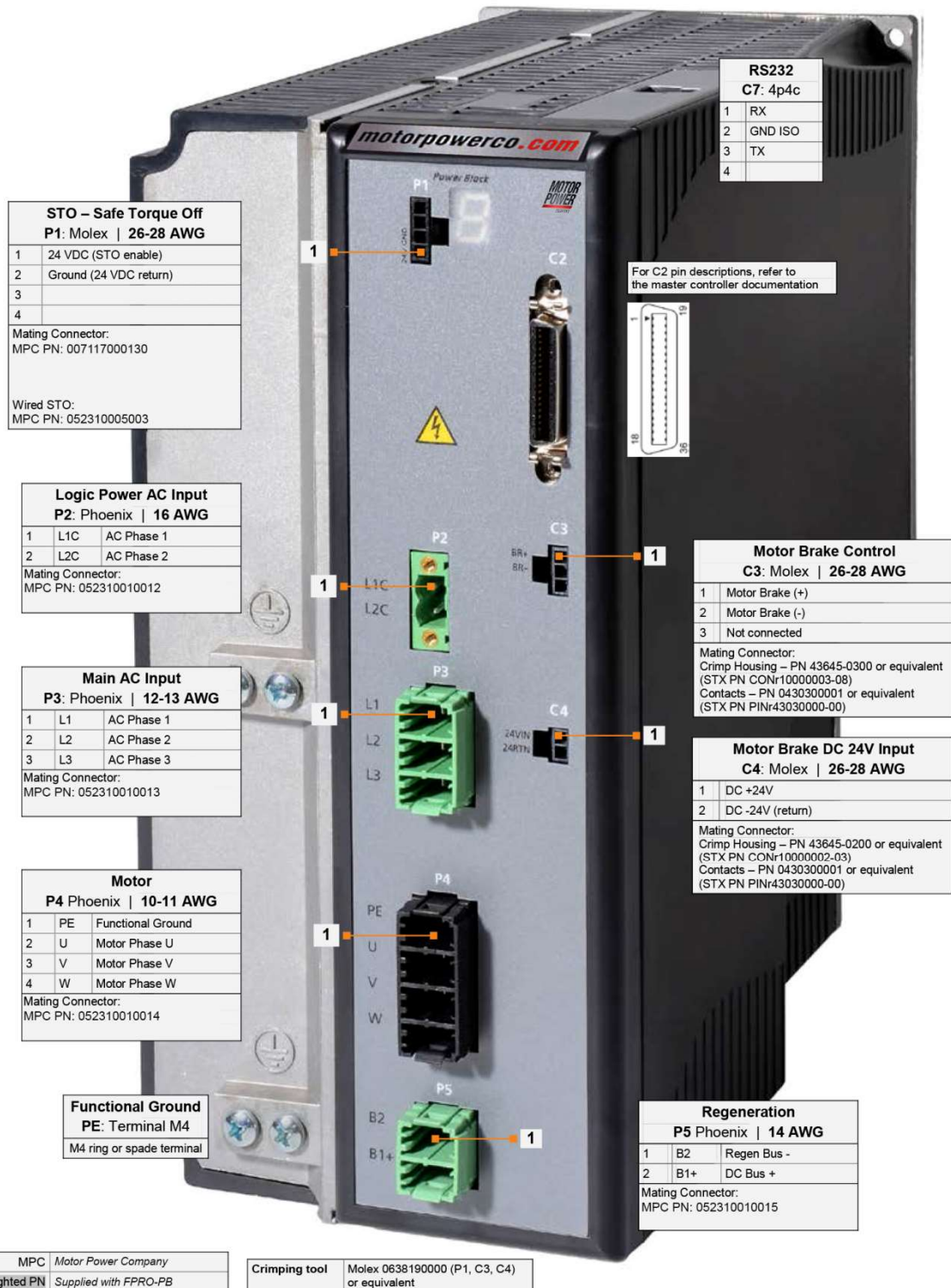


Figure 4-14. Pin Assignments on FLEXI PRO-020/FLEXI PRO-024 – AP/AF/EC Models (120/240 VAC)

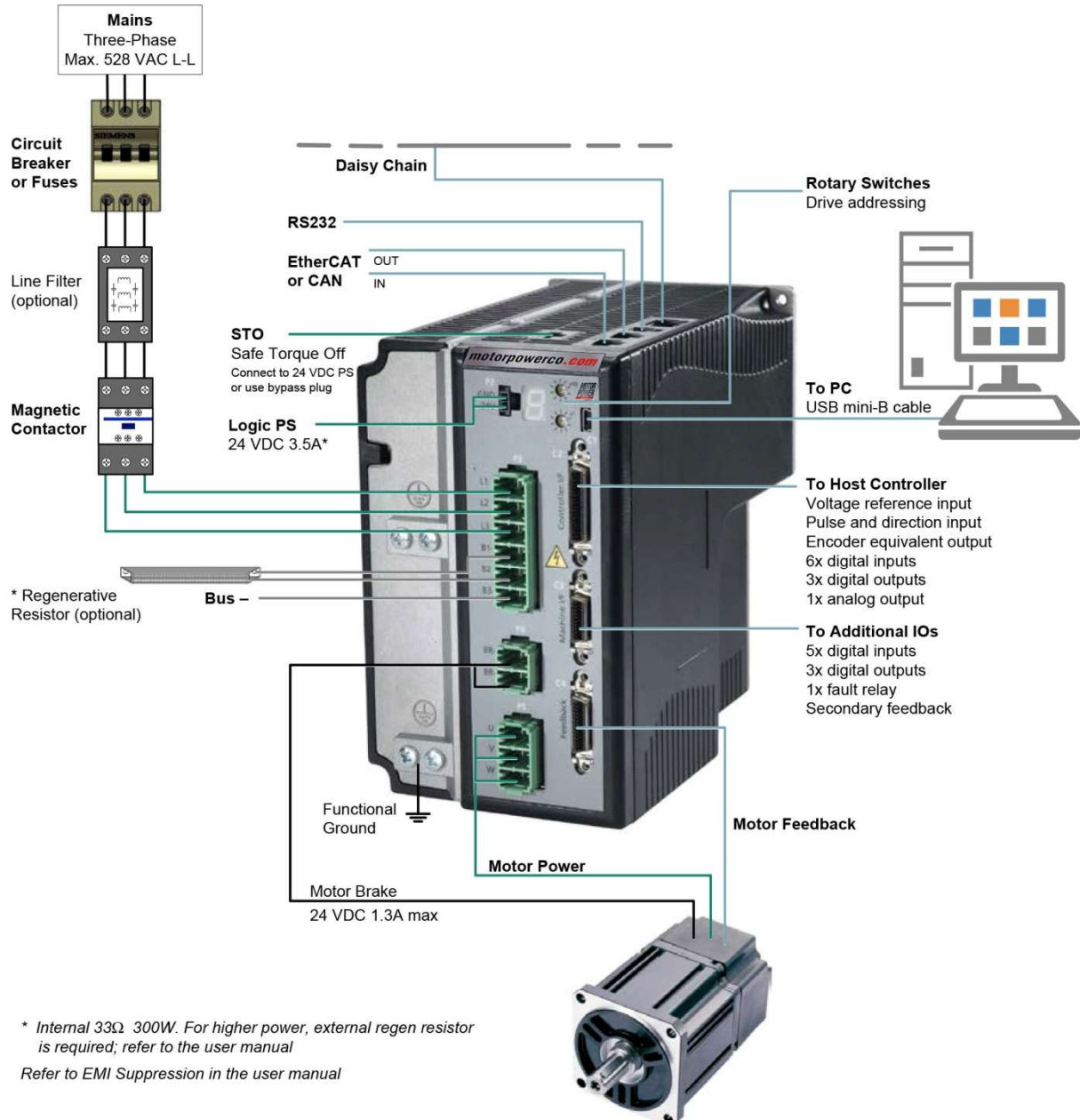


**Figure 4-15. Pin Assignments on FLEXI PRO-020/FLEXI PRO-024 – EB Models (120/240 VAC)**

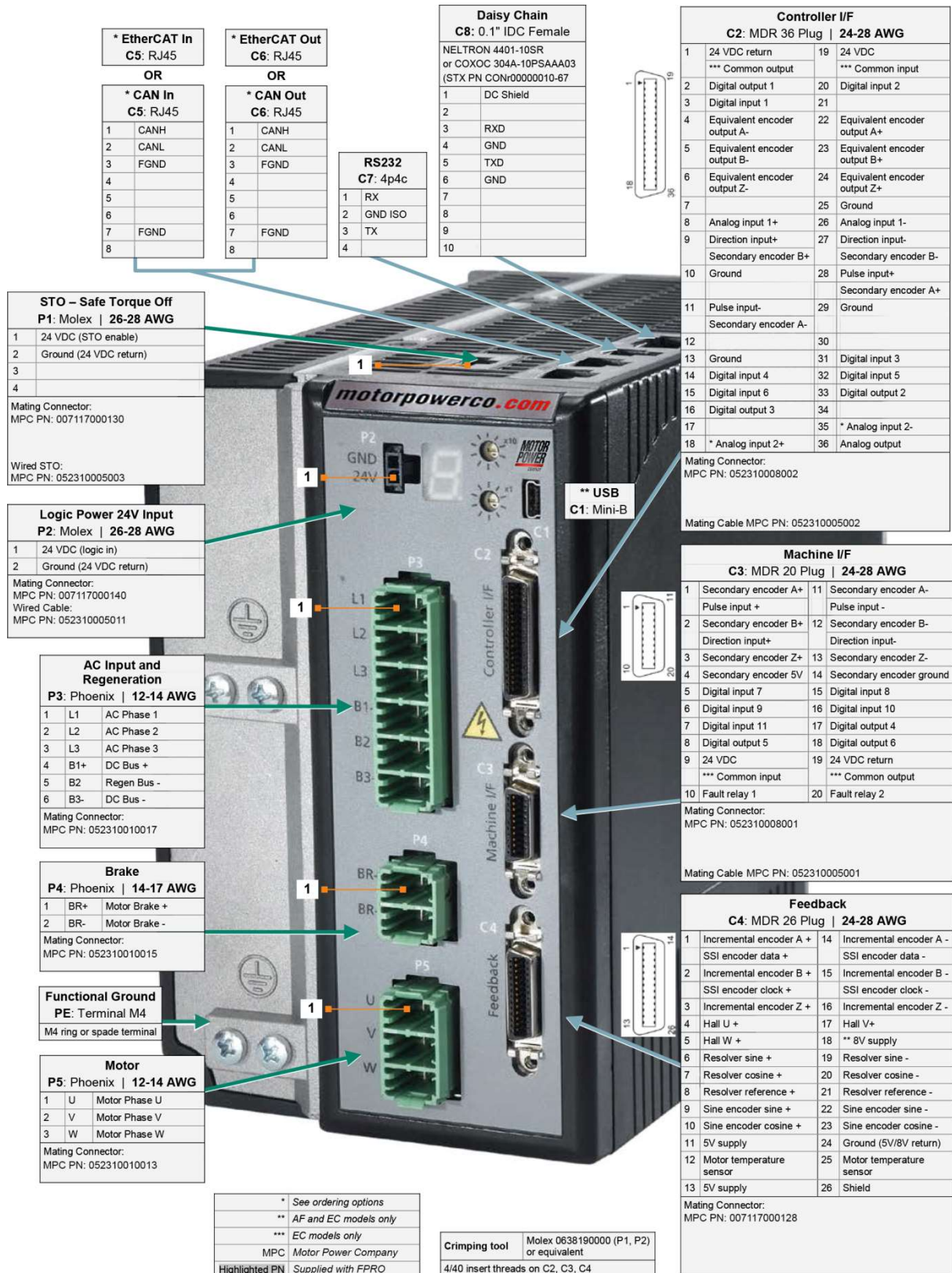


**Figure 4-16. Pin Assignments on FLEXI PRO-020/FLEXI PRO-024 – PB Models (120/240 VAC)**

## 4.5 FLEXI PRO-003/FLEXI PRO-006 (400/480 VAC) Wiring and Pin Assignments

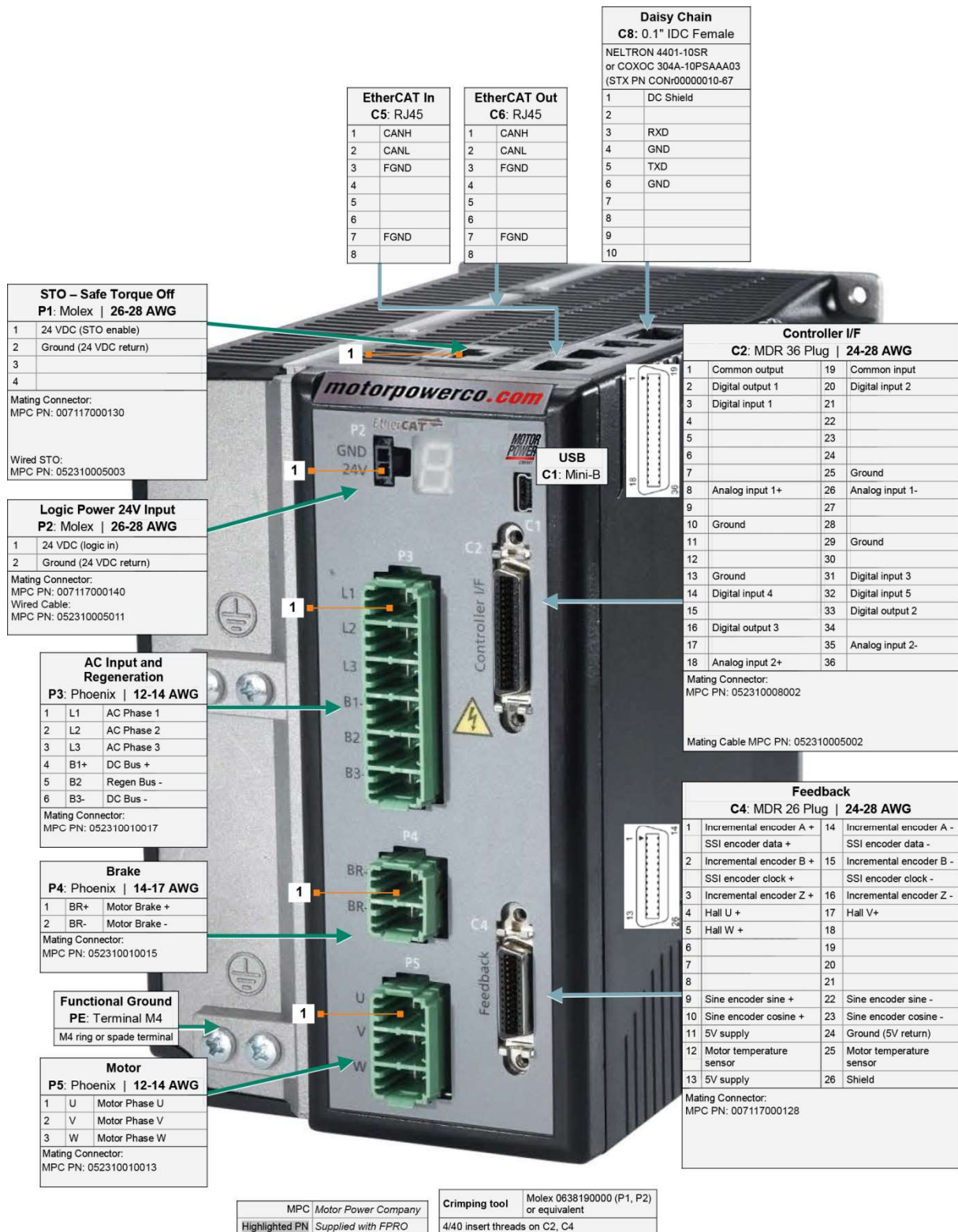


**Figure 4-17. Servo System Wiring, 3-Phase – FLEXI PRO-003/FLEXI PRO-006 – Models (400/480 VAC)**

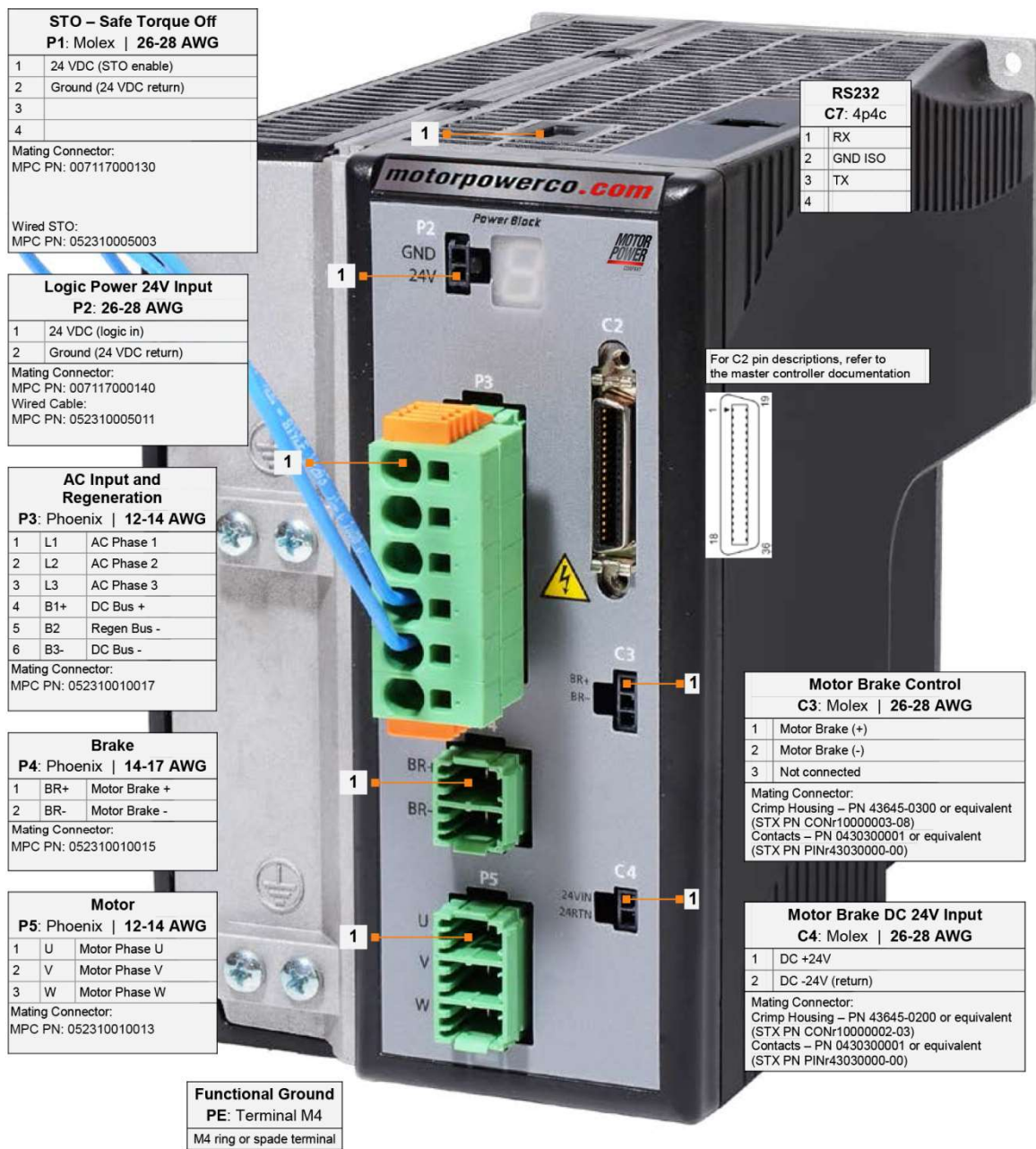


**Figure 4-18. Pin Assignments on FLEXI PRO-003/FLEXI PRO-006 – AP/AF/EC Models (400/480 VAC)**





**Figure 4-19. Pin Assignments on FLEXI PRO-003/FLEXI PRO-006 – EB Models (400/480 VAC)**

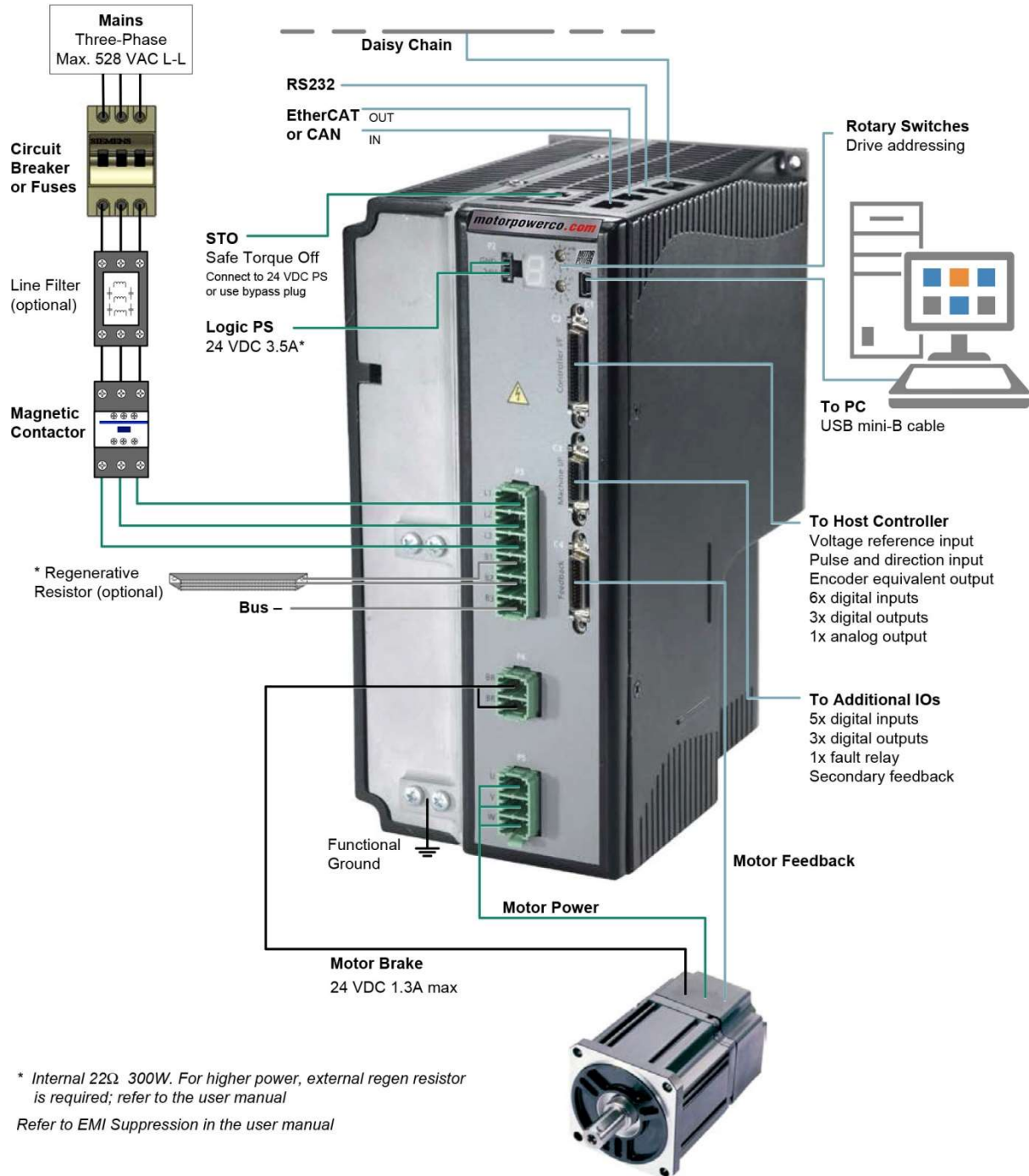


MPC	Motor Power Company
Highlighted PN	Supplied with FPRO-PB

Crimping tool	Molex 0638190000 (P1, P2, C3, C4) or equivalent
---------------	---

**Figure 4-20. Pin Assignments on FLEXI PRO-003/FLEXI PRO-006 – PB Models (400/480 VAC)**

## 4.6 FLEXI PRO-012 (400/480 VAC) Wiring and Pin Assignments



**Figure 4-21. Servo System Wiring, 3-Phase – FLEXI PRO-012 (400/480 VAC)**

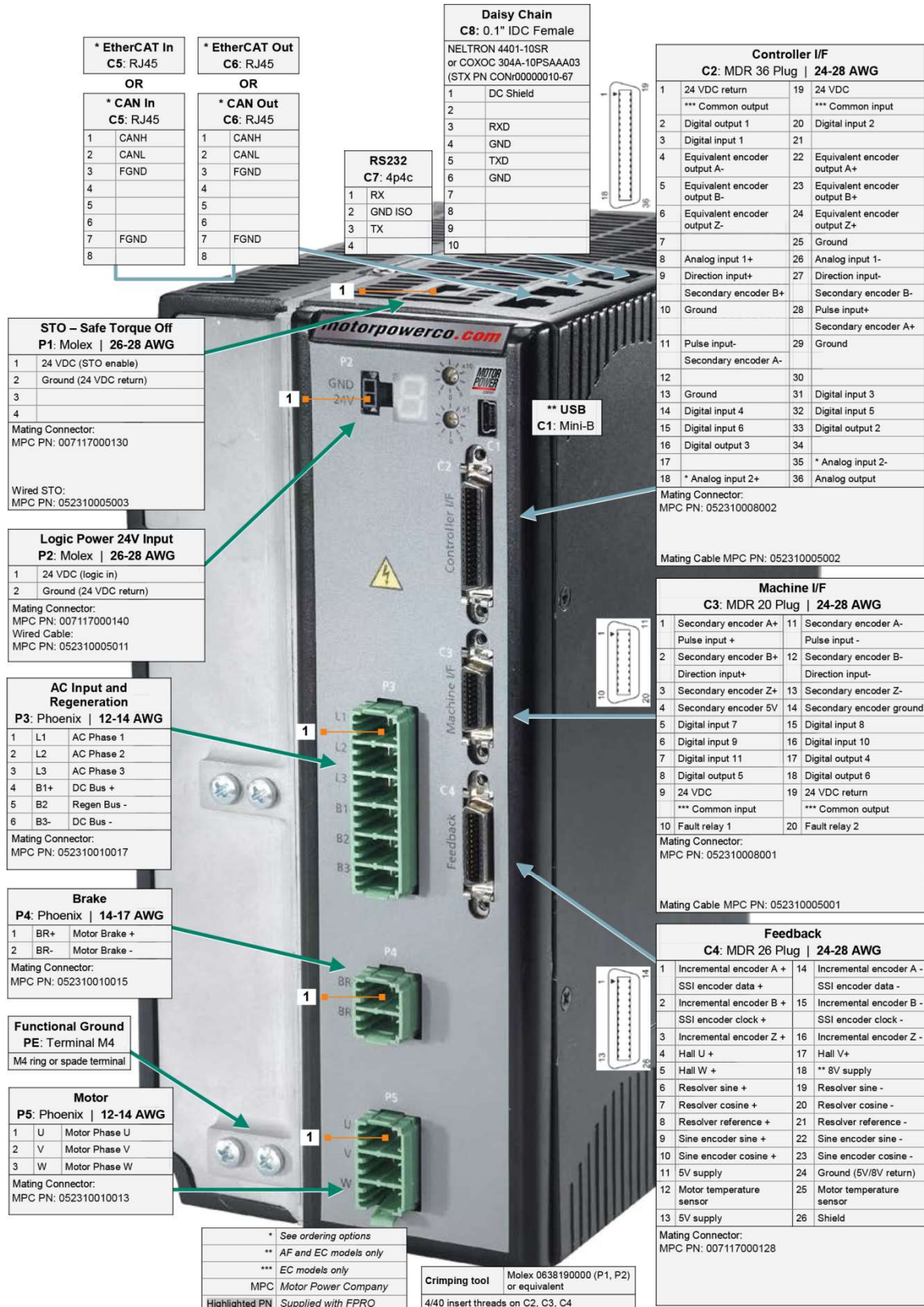
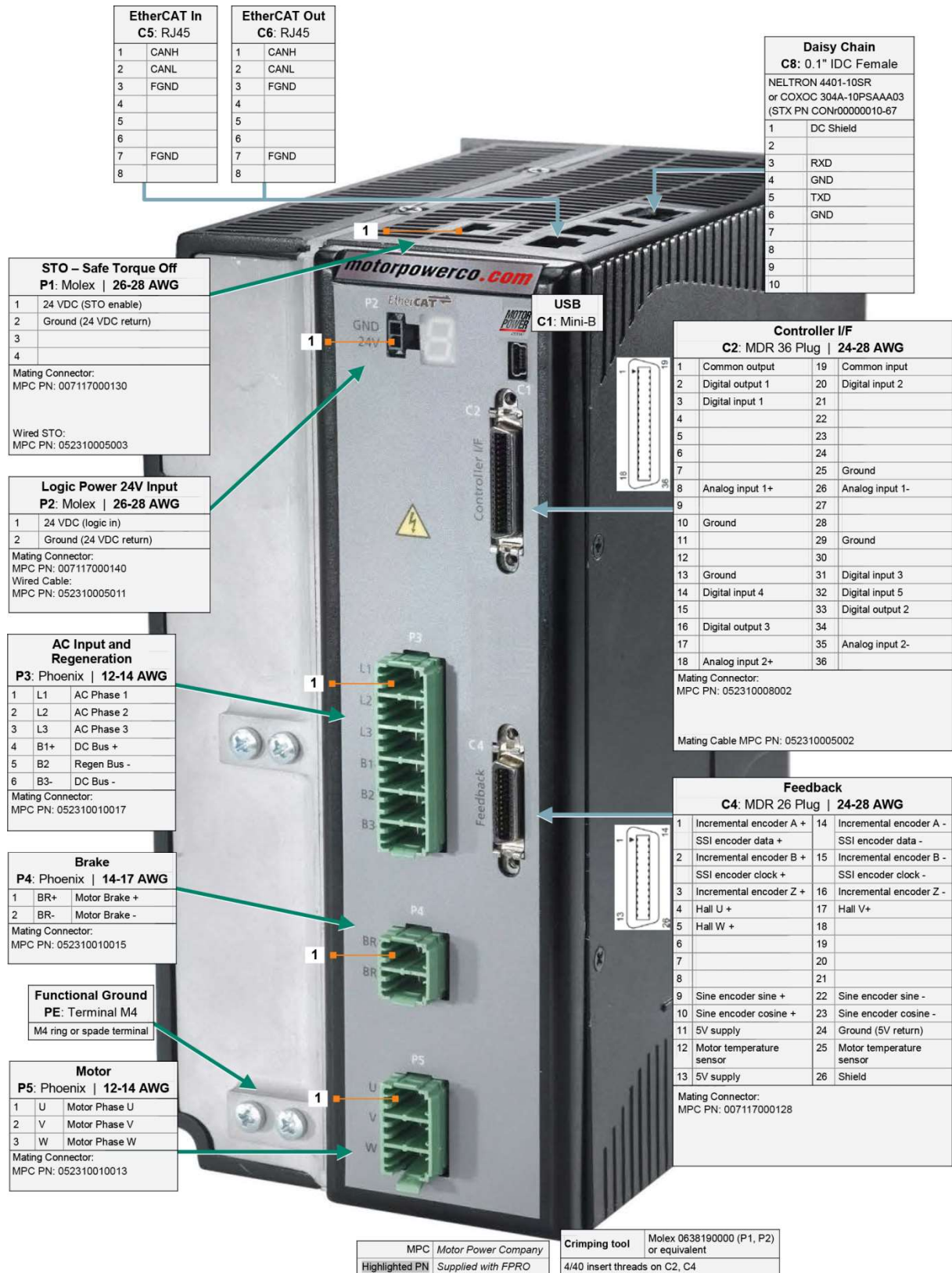
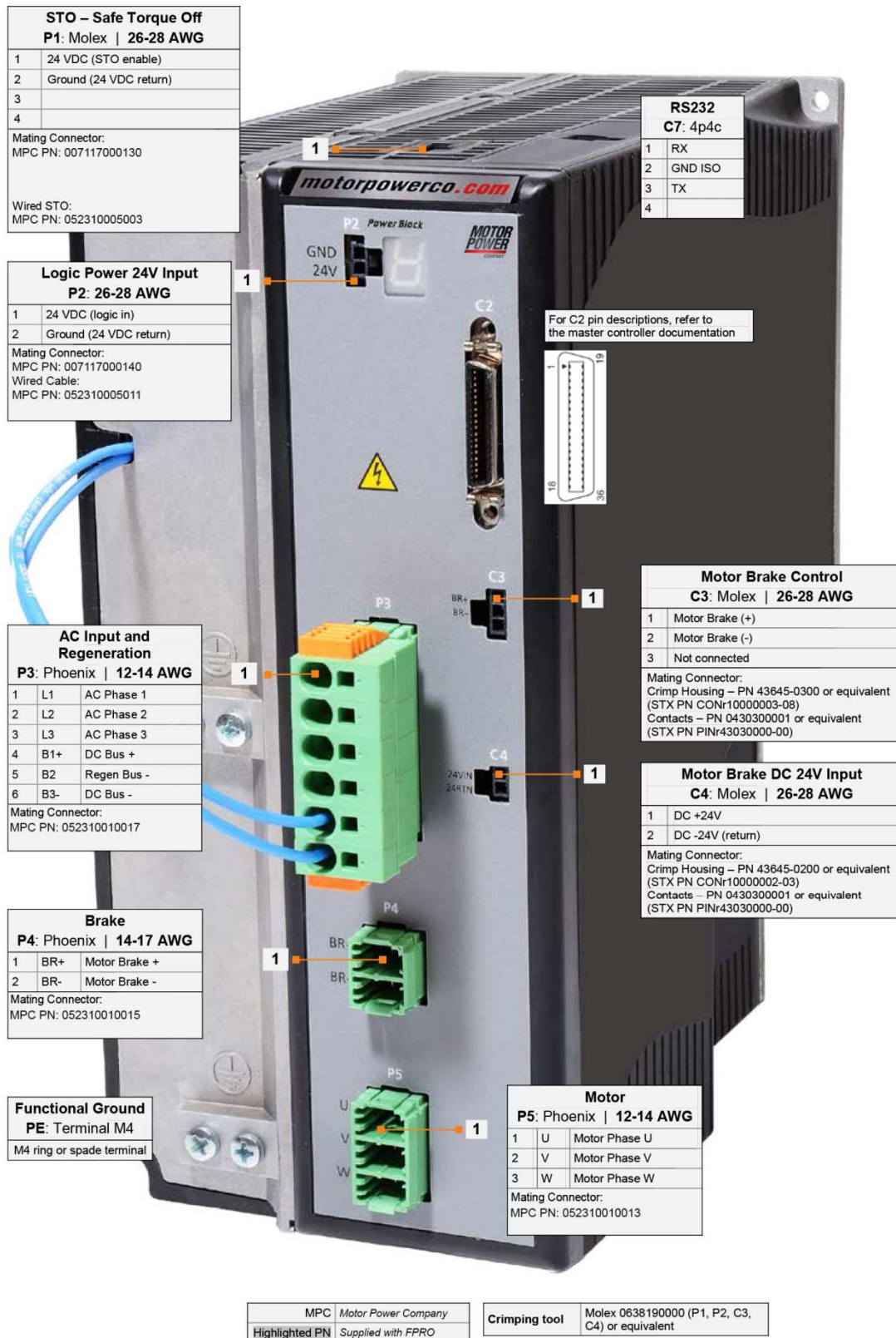


Figure 4-22. Pin Assignments on FLEXI PRO-012 – AP/AF/EC Models (400/480 VAC)



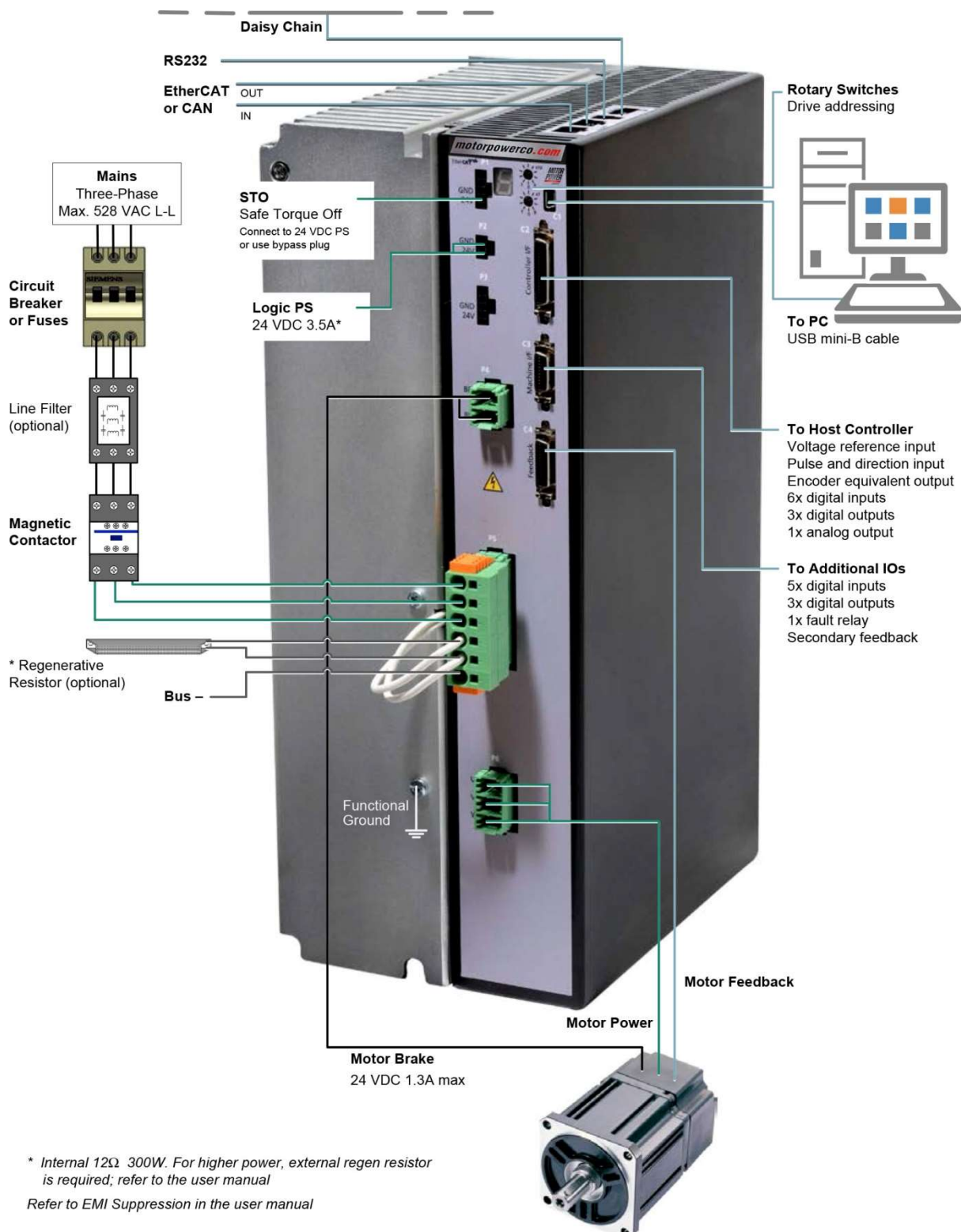
**Figure 4-23. Pin Assignments on FLEXI PRO-012 – EB Models (400/480 VAC)**





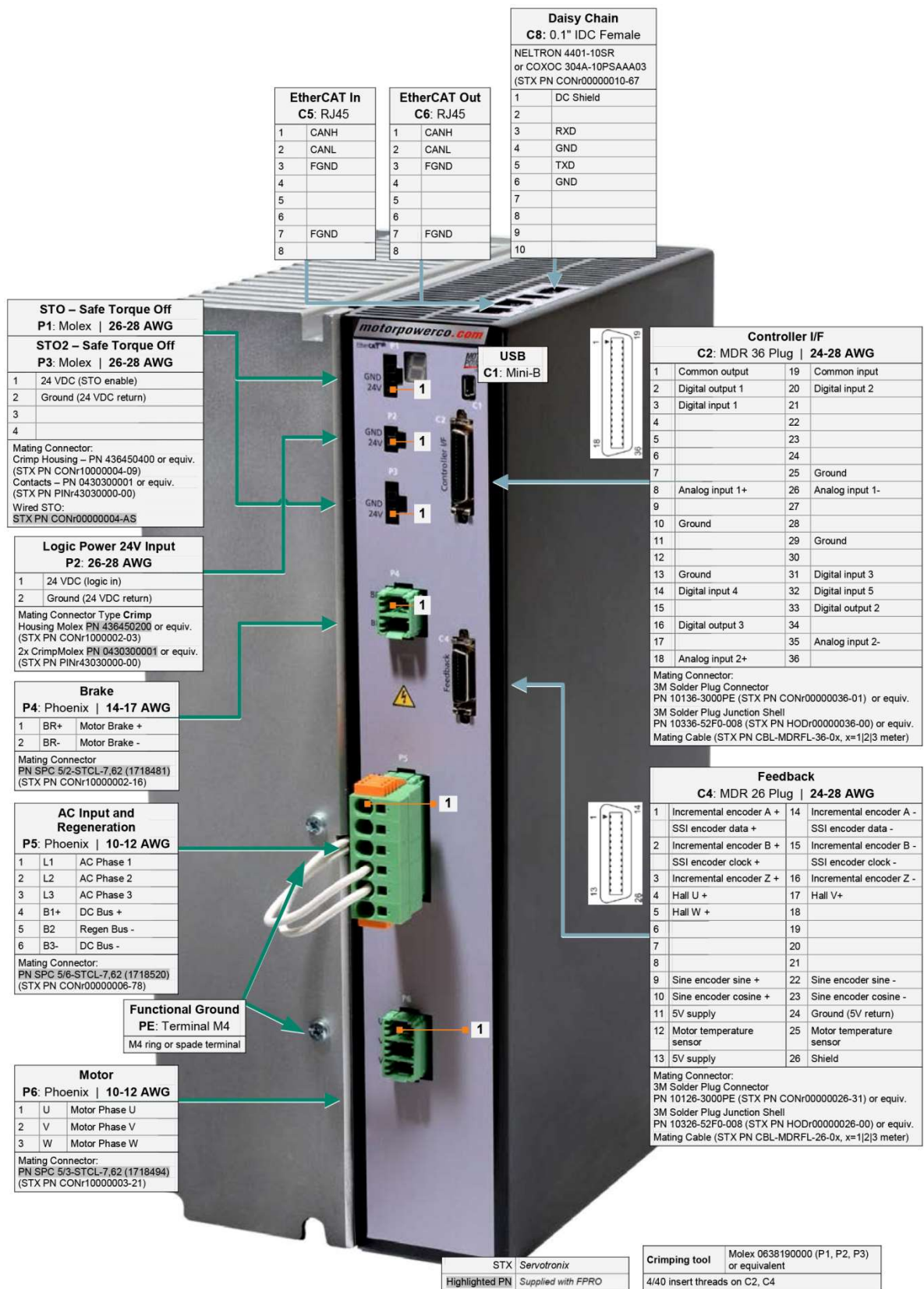
**Figure 4-24. Pin Assignments on FLEXI PRO-012 – PB Models (400/480 VAC)**

## 4.7 FLEXI PRO-024/FLEXI PRO-030 (400/480 VAC) Wiring and Pin Assignments



**Figure 4-25. Servo System Wiring, 3-Phase – FLEXI PRO-024/FLEXI PRO-030 (400/480 VAC)**





**Figure 4-26. Pin Assignments on FLEXI PRO-024/FLEXI PRO-030 – AP/AF/EC Models (400/480 VAC)**



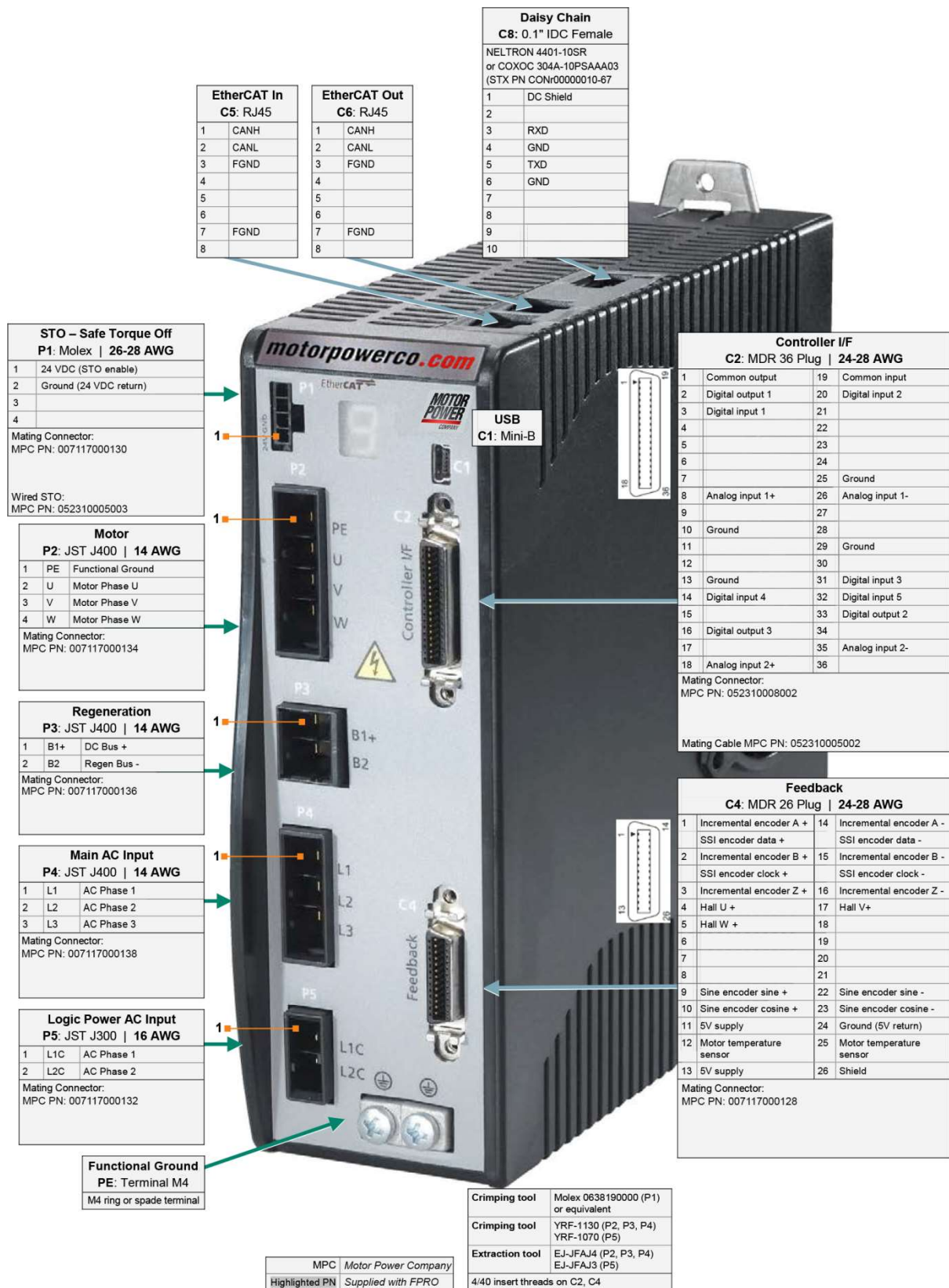


Figure 4-27. Pin Assignments on FLEXI PRO-024/FLEXI PRO-030 – EB Models (400/480 VAC)

## 4.8 Controller Interface Wiring

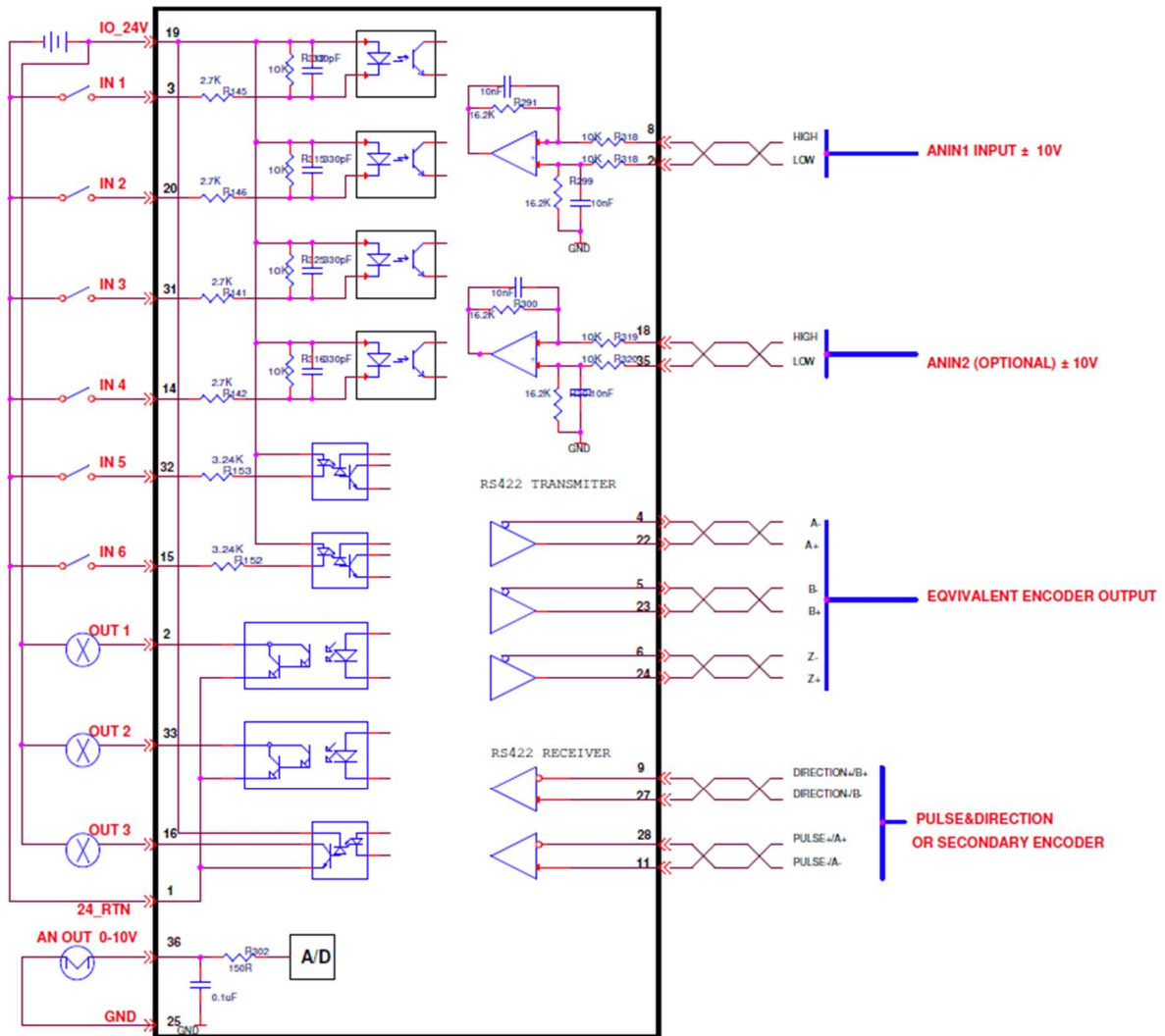


Figure 4-28. Controller Interface Wiring – AP/AF Models

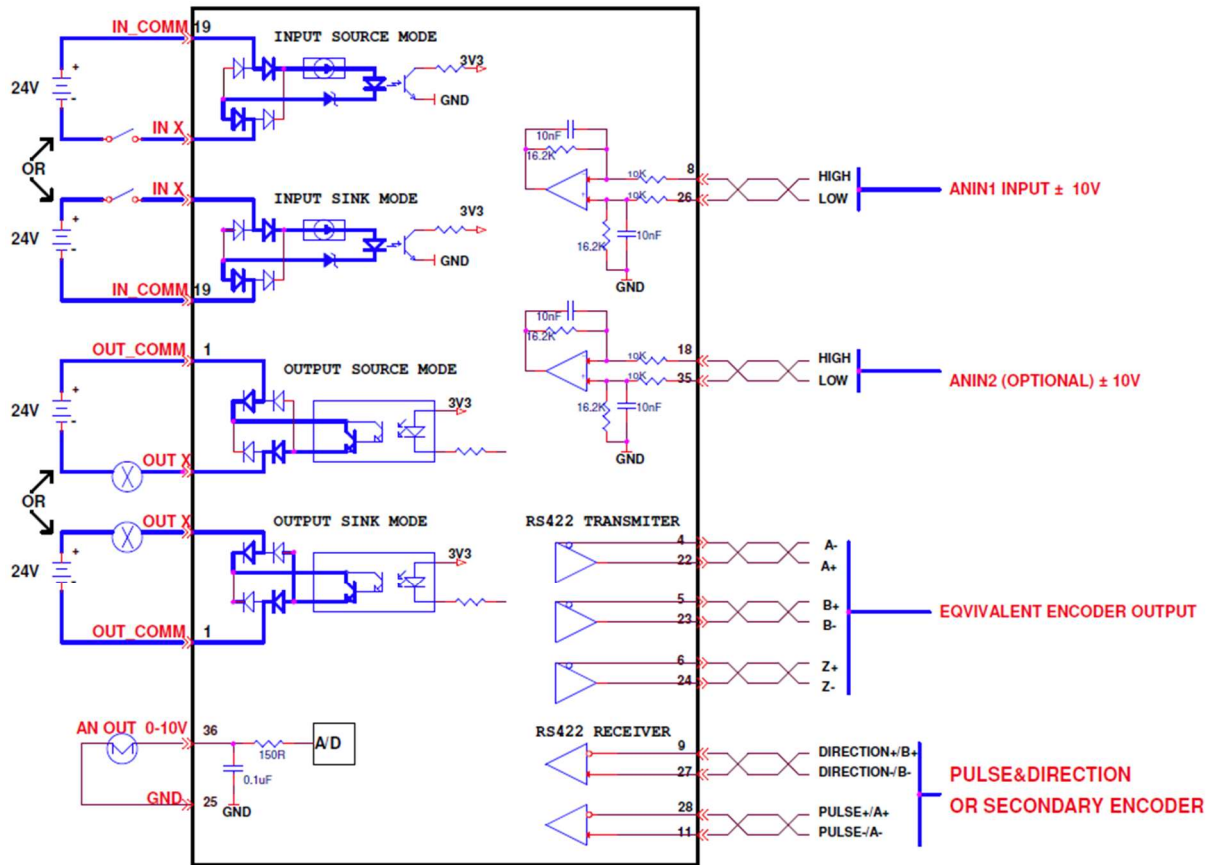


Figure 4-29. Controller Interface Wiring – EC Models

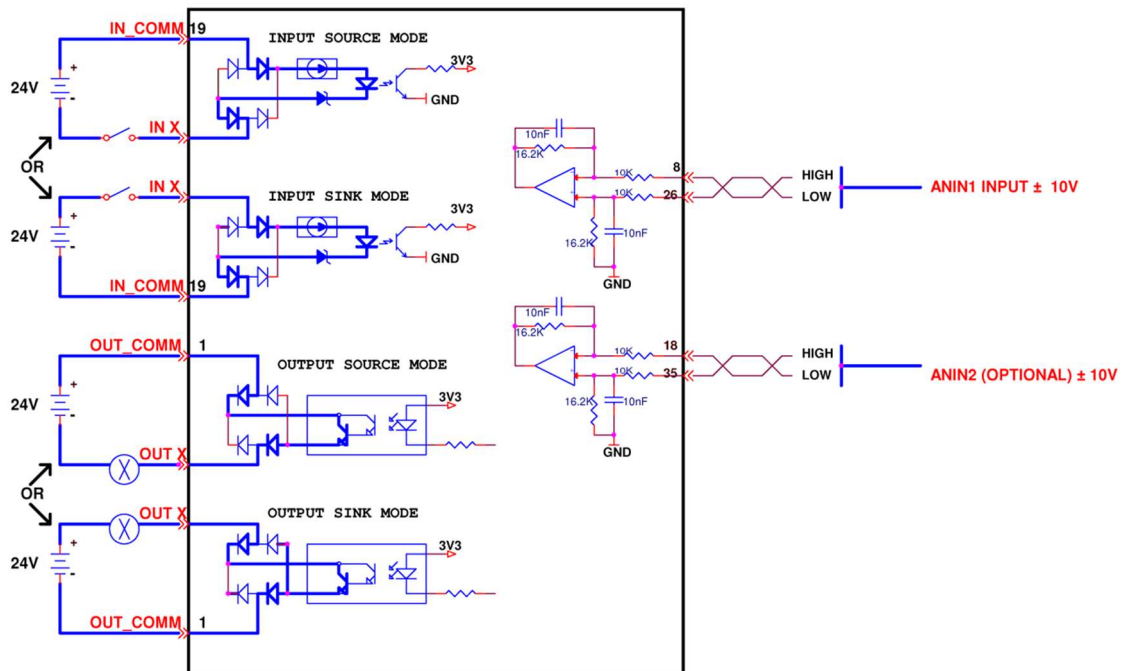


Figure 4-30. Controller Interface Wiring – EB Models

## 4.9 Machine Interface Wiring

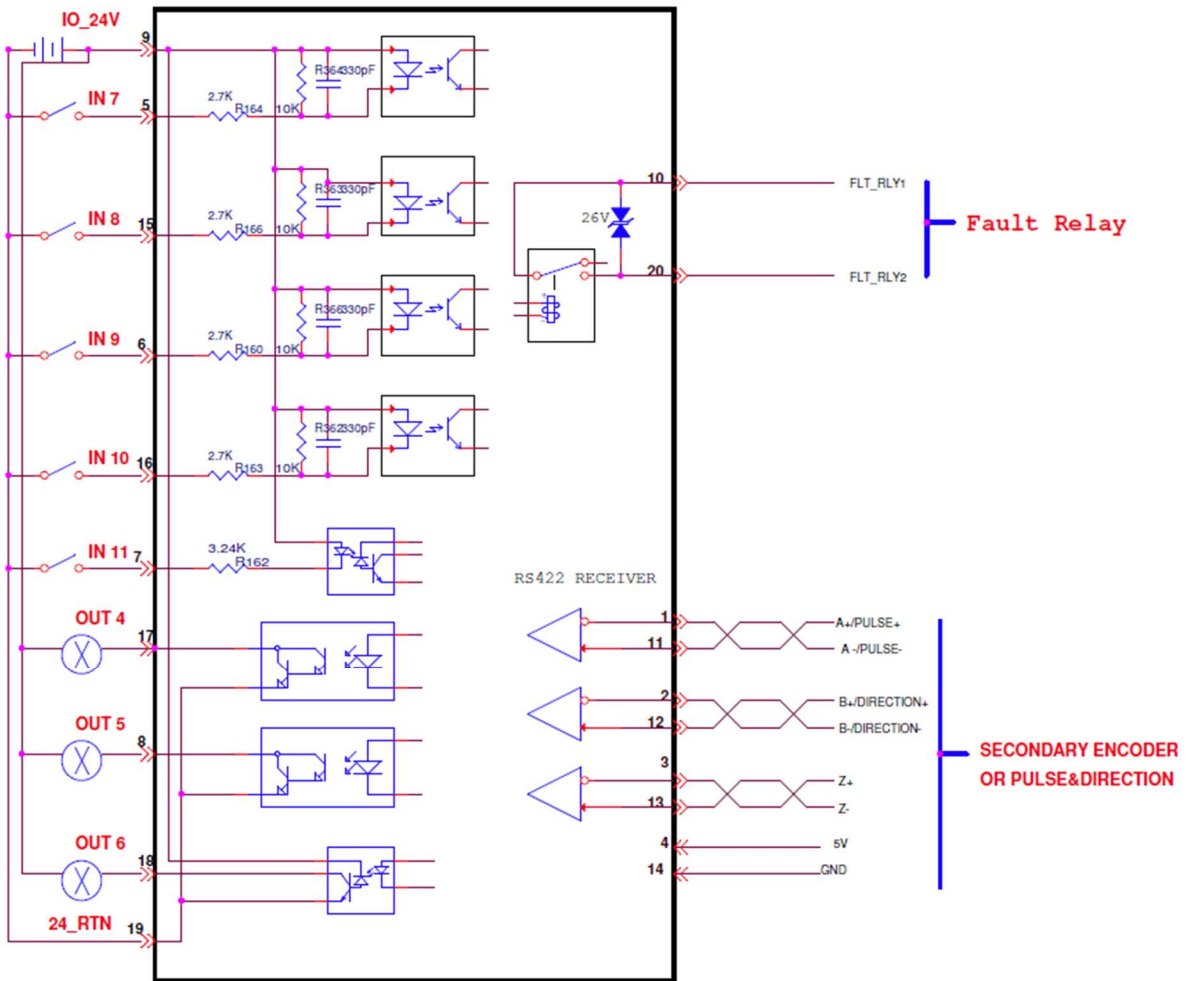


Figure 4-31. Machine Interface Wiring Diagram – AP/AF Models

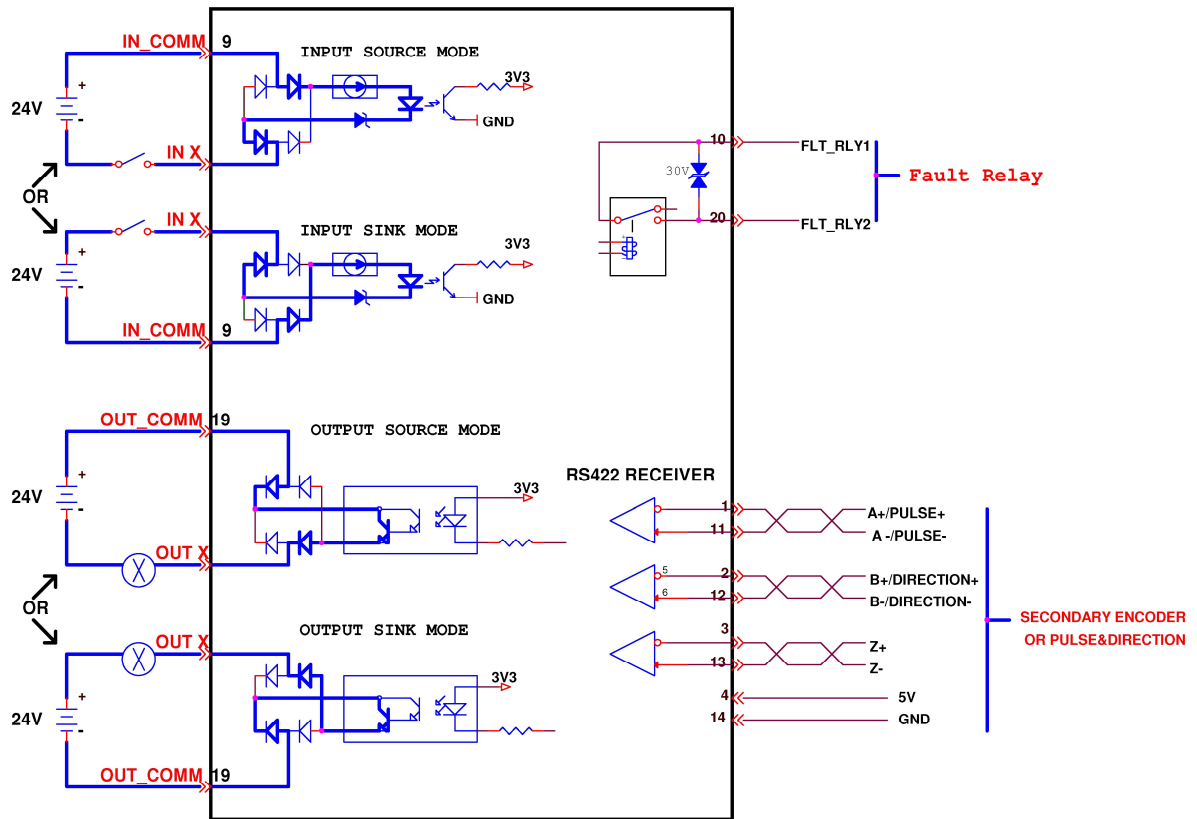


Figure 4-32. Machine Interface Wiring Diagram – EC Models





## 5 Drive Setup

### 5.1 Setup Overview

Perform the following steps to install and setup a FLEXI PRO system.

1. Mount the FLEXI PRO.
2. Make all electrical connections:
  - Controller I/Os and/or Machine I/Os
  - Motor feedback
  - Fieldbus devices, if required
  - Safe torque off (STO), or bypass using jumpers
  - Motor
  - Regeneration resistor, if required
  - Motor brake, if required
  - AC input voltage.
3. Set the drive address using the rotary switches.
4. Connect the drive to the host computer.
5. Power up the drive and the host computer.
6. Install Flexi SUITE software.
7. Using Flexi SUITE, configure and test the drive.

### 5.2 Preparation

#### 5.2.1 Hardware and Tools

All required hardware and tools are specified in the diagrams in the chapter *Wiring*.

Connectors and tools that are supplied with the FLEXI PRO are also indicated in those diagrams, and in the table below:

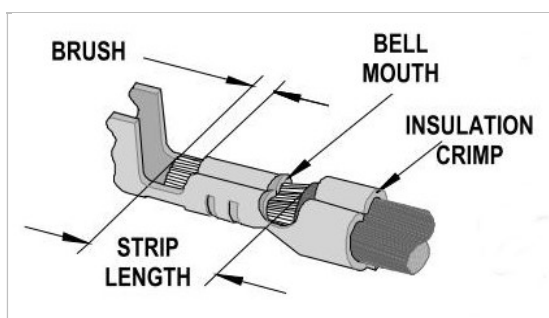
**Table 5-1. Required Tools (if not using ready-made cable assemblies)**

<b>120/240 VAC Models</b>	
<b>Item</b>	<b>FLEXI PRO-1D5 FLEXI PRO-003</b>
Crimping tool	Molex 0638190000 (P1)
Crimping tool	YRF-880 (P2, P3)
Extraction tool	EJ-JFAJ3 (P2, P3)
Key for spring connector	J-FAT-OT (supplied)

<b>Item</b>	<b>FLEXI PRO-4D5</b> <b>FLEXI PRO-006</b>
Crimping tool	Molex 0638190000 (P1)
Crimping tool	YRF-1070 (P2, P3, P4)
Extraction tool	EJ-JFAJ3
Key for spring connector	J-FAT-OT (supplied)
<b>Item</b>	<b>FLEXI PRO-008</b> <b>FLEXI PRO-010</b> <b>FLEXI PRO-013</b>
Crimping tool	Molex 0638190000 (P1)
Crimping tool	YRF-1130 (P2, P3, P4) YRF-1070 (P5)
Extraction tool	EJ-JFAJ4 (P2, P3, P4) EJ-JFAJ3 (P5)
<b>Item</b>	<b>FLEXI PRO-020</b> <b>FLEXI PRO-024</b>
Crimping tool	Molex 0638190000 (P1)
<b>400/480 VAC Models</b>	
<b>Item</b>	<b>FLEXI PRO-003</b> <b>FLEXI PRO-006</b> <b>FLEXI PRO-012</b> <b>FLEXI PRO-024</b> <b>FLEXI PRO-030</b>
Crimping tool	Molex 0638190000 (P1, P2) (also P3 on FLEXI PRO-024/030)

## Crimping

Prior to crimping, strip 2 mm at the end of wire, as shown in Figure 5-1.



**Figure 5-1. Stripped Wire in Crimp Pin**

In addition, you will need:

- A small slotted screwdriver for setting switches.
- M4 ring or spade terminal for grounding.

To connect the FLEXI PRO to the host computer via serial communication, you will need one of the following:

- USB 2.0 A to Mini-B cable (USB interface)
- 4p4c plug and cable (RS232 interface)

To connect the FLEXI PRO to the host computer or host PLC via fieldbus:

- RJ45 cables (CAN interface or EtherCAT)

## 5.2.2 Host Computer System

The following computer system and software are required:

- 2 GHz CPU
- 1 GB RAM
- 1000 MB available on hard drive (after .net 4 is installed)
- Communication interface for connection to the drive; one of the following:
  - USB port
  - USB port and USB-to-RS232 adaptor with ferrite bead
  - RS232 port
- Operating system: Windows XP-SP3, Windows 7, Windows 8. 32-bit or 64-bit.
- Recommended screen resolution for Flexi SUITE is 1280x800. Minimal resolution is 1024x768.
- **Flexi SUITE**, the graphical software interface for configuring and testing the drive. Download from the Motor Power Company website or contact Technical Support.
- **.Net4** (for details, refer to [.NET Framework System Requirements](#)). If .NET 4 is not installed on the computer, Flexi SUITE will guide you through the installation, but will not install it automatically.

**Note:** Some editions of Windows 8 require digitally signed drivers. Flexi SUITE includes an unsigned USB driver. To install the USB driver, you must first disable driver signature verification ([Example](#)).

## 5.2.3 Files for Fieldbus Devices

- **EDS file** for FLEXI PRO (if using CAN protocol) on the host computer or PLC controller. Download from the Motor Power Company website or contact Technical Support.
- **XML file** for FLEXI PRO (if using EtherCAT protocol) on the host computer or PLC controller. Download from the Motor Power Company website or contact Technical Support.

## 5.3 EMI Suppression

### 5.3.1 CE Filtering Techniques

The FLEXI PRO drive complies with the CE standards specified in the section *Standards Compliance*. Proper bonding, grounding and filtering techniques must be applied in order to meet this standard.

Noise currents often occur in two types. The first is conducted emissions that are passed through ground loops. The quality of the system grounding scheme inversely determines the noise amplitudes in the lines. These conducted emissions are of a common-mode nature from line to neutral (or ground). The second is radiated high-frequency emissions usually capacitively coupled from line-to-line and are differential in nature.

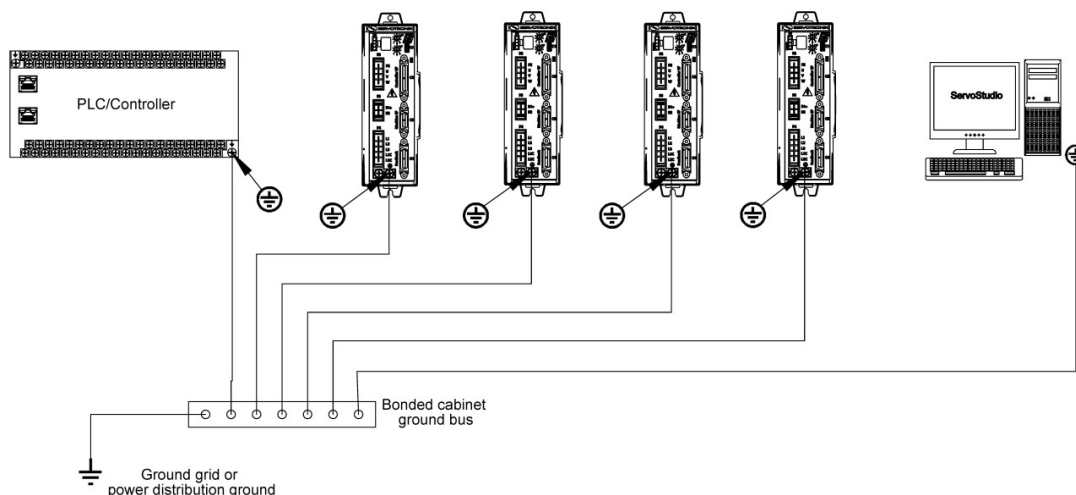
To properly mount the EMI filters, the enclosure should have an unpainted metallic surface. This allows for more surface area to be in contact with the filter housing and provides a lower impedance path between this housing and the back plane. The back panel, in turn, has a high frequency ground strap connection to the enclosure frame or earth ground.

### 5.3.2 Grounding



When connecting the FLEXI PRO to other control equipment, be sure to follow two basic guidelines to prevent damage to the drive:

- The FLEXI PRO must be grounded via the earth ground of the main AC voltage supply.
- Any motion controller, PLC or PC that is connected to the FLEXI PRO must be grounded to the same earth ground as the FLEXI PRO.



**Figure 5-2. FLEXI PRO System Grounding**

System grounding is essential for proper performance of the drive system.

The AC input voltage ground wire must be connected to the PE terminal, located on the FLEXI PRO front panel. This is necessary for both safety and EMI reduction.

Use a single point ground for the system (start wiring) to avoid ground loops.

It is strongly recommended that the FLEXI PRO be mounted to a metallic back panel, and that a high frequency ground be provided to connect the back panel to earth ground. Provide an electrical connection across the entire back surface of the drive panel. Electrically-conductive panels such as aluminum or galvanized steel are recommended. For painted and other coated metal panels, remove all coating behind the drive. The objective is to provide an extremely low impedance path between the filters, drives, power supplies, and earth ground for high-frequency signals that might cause EMI. Use a flat braid or copper bus bar to achieve high-frequency grounding. Use the shortest braid possible when connecting high frequency grounds.

Ensure good connections between the cabinet components. Connect the back panel and cabinet door to the cabinet body using several conductive braids. Never rely on hinges or mounting bolts for ground connections. Ensure good ground connection from cabinet to proper earth ground. Ground leads should be the same gauge as the leads to main power or one gauge smaller.

The host computer must also be properly grounded.

### 5.3.3 Shielding and Bonding

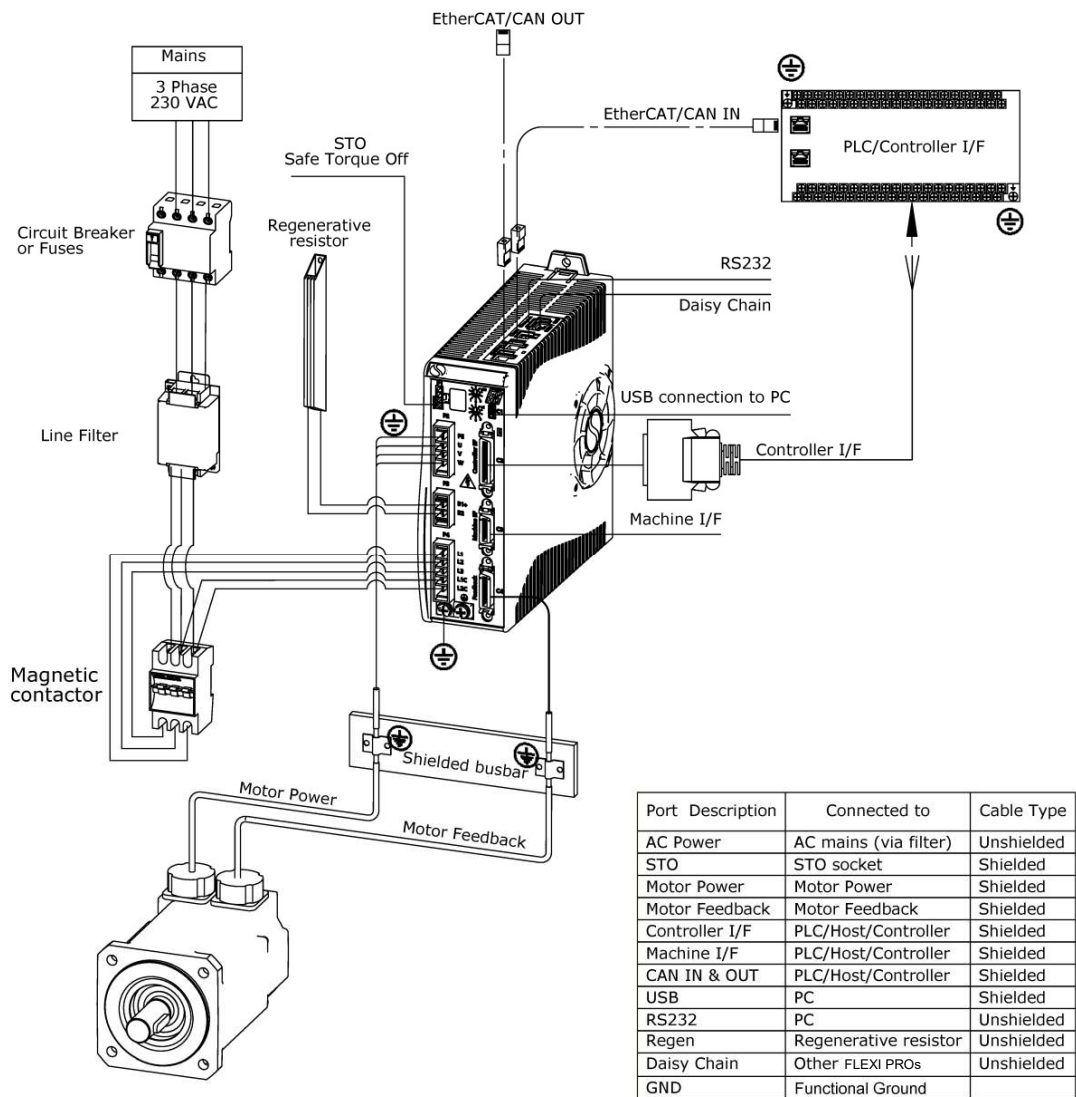


Figure 5-3. FLEXI PRO Shielding and Bonding

Motor and feedback cables must be shielded in order to minimize noise emissions and increase the immunity levels of the drive system. The shield should be connected to ground at both ends.

The proper bonding of shielded cables to a grounded surface is imperative for minimizing noise emissions and increasing immunity levels of the drive system. Its effect is to reduce the impedance between the cable shield and the back panel. It is recommended that all shielded cables be bonded to the back panel.

The motor and feedback cables should have the shield exposed as close to the drive as possible. This exposed shield is bonded to the back panel using either non-insulated metallic cable clamps or cable bonding clamps.

It is recommended to use a star point shield connection, for example with a shielding busbar.

For cables entering a cabinet, connect shields on all 360° of the cable.

Lines between servo drives and filters and external brake resistor must be shielded.

### 5.3.4 Input Power Filtering

The FLEXI PRO electronic system components require EMI filtering in the input power leads to meet the CE/EMC requirements for the industrial environment. This filtering blocks conducted type emissions from exiting onto the power lines and provides a barrier for EMI on the power lines.

Care must be taken to adequately size the system. The type of filter is determined according to the voltage and current rating of the system and whether the incoming line is single- or three-phase. One input line filter can be used for multi-axis control applications.

Implementation of the input power filter must adhere to the following guidelines:

- Maintain separation of leads entering and exiting the mains filter.
- Filter must be mounted on the same panel as the drive.
- Filter must be mounted as close as possible to the drive, to prevent noise from being capacitively coupled into other signal leads and cables.
- When mounting the filter to the panel, remove any paint or material covering. Use an unpainted metallic back panel, if possible.
- Filters are provided with a ground connection. All ground connections must be tied to ground.
- Filters can produce high leakage currents. Filters must be grounded before connecting the supply!
- Filters should not be touched for 10 seconds after removing the supply.

### 5.3.5 Motor Line Filtering

Motor line filtering using ferrite cores might be necessary for CE compliance of FLEXI PRO systems. This additional filtering can increase the reliability of the system. Poor non-metallic enclosure surfaces and lengthy, unbonded (or unshielded) motor cables that couple noise line-to-line (differential) are just some of the factors that result in a need for motor lead filtering.

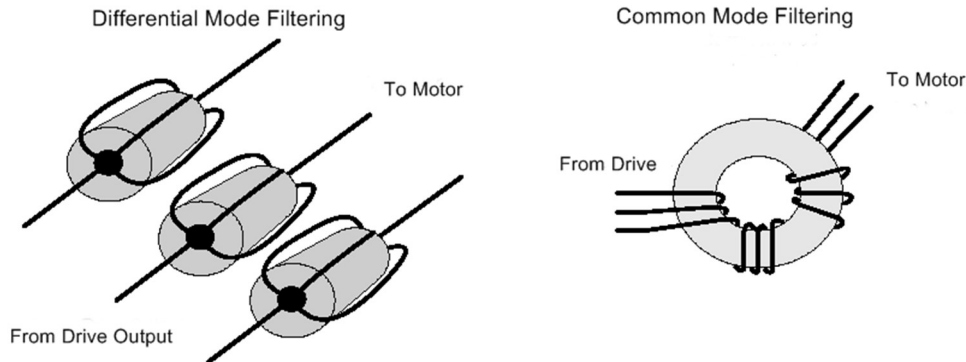
Motor lead noise may be either common-mode or differential. The common-mode conducted currents occur between each motor lead and ground (line-to-ground). Differential radiated currents exist from one motor lead to another

(line-to-line). Filtering the lines feeding the motor provides additional reduction of noise currents that enter surrounding cables and equipment I/O ports in close proximity.

Loop each motor lead through the core several times, as shown in *Figure 5-4*.



**Never loop a ground lead through a core.**



**Figure 5-4. Mode Line Filtering**

### 5.3.6 I/O Signal Filtering

I/O filtering may be desirable (depending on system installation, application, and integration with other equipment). To avoid unwanted signals entering and disturbing the drive system or other associated equipment, place ferrite cores on I/O lines.

### 5.3.7 Additional EMI Suppression Recommendations

Route power and control cables separately. A distance of at least 200 mm is recommended, and improves the interference immunity.

If input power and motor leads need to cross, make sure they cross at 90°.

Feedback lines may not be extended, since this would cause the shielding to be interrupted, and possibly disturb the signal processing.

Splice cables properly. If you need to divide cables, use connectors with metal backshells. Make sure that both shells connect along the full 360° of the shields. No portion of the cabling should be unshielded. Never divide a cable across a terminal strip.

For differential inputs for analog signals, use twisted-pair, shielded signal lines, connecting shields on both ends.

## 5.4 Electrical System Considerations

### 5.4.1 Fusing

Integral solid state short circuit protection does not provide branch circuit protection. Branch circuit protection must be provided in accordance with the National Electrical Code and any additional local codes, so fusing is required.

- **US fuses:** Class RK5 or CC or J or T, 600 VAC 200 kA, time-delay. The fuse must be UL and CSA listed; UR-recognized is not sufficient.
- **EU fuses:** Types gRL or gL, 400 V/500 V, time-delay.

- **Fuse holders:** Standard fuse blocks, or finger-safe fuse holders according to IEC 60529. For example:
  - Bussmann: CH Series modular fuse holders, fuse size 0 to 30A, class J, 3 poles: CH30J3
  - Ferraz: Ultrasafe fuse holders, fuse size 0 to 30A, class J, 3 poles: US3J3I

## 5.4.2 Leakage Current Considerations

Leakage current via the PE conductor results from the combination of equipment and cable leakage currents. The leakage current frequency pattern comprises a number of frequencies, whereby the residual-current circuit breakers definitively evaluate the 50 Hz current. For this reason, the leakage current cannot be measured using a conventional multimeter.

As a rule of thumb, the following assumption can be made for leakage current on cables, depending on the PWM frequency of the output stage:

- $I_{leak} = n \times 20 \text{ mA} + L \times 1 \text{ mA/m}$  at 8 kHz PWM frequency at the output stage
- $I_{leak} = n \times 20 \text{ mA} + L \times 2 \text{ mA/m}$  at a 16 kHz PWM frequency at the output stage

(where  $I_{leak}$ =leakage current,  $n$ =number of drives,  $L$ =length of motor cable)

Since the leakage current to PE is greater than 3.5 mA, compliance with IEC61800-5-1 requires that either the PE connection be doubled or a connecting cable with a cross-section greater than 10 mm<sup>2</sup> be used. Use the PE terminal and the PE connection screws to meet this requirement.

## 5.4.3 Residual Current Protective Device (RCD)

In compliance with standards IEC 60364-4-41 Regulations for Installation and IEC 60204 Electrical Equipment of Machinery, residual current protective devices (RCD) can be used provided the requisite regulations are met.

RCDs which are sensitive to all currents must be used in order to detect any DC fault current.

To protect against direct contact (with motor cables shorter than 5 m), it is recommended that each drive be protected individually using a 30 mA RCD, which is sensitive to all currents.



## 5.5 Mechanical Installation

### 5.5.1 Mounting the FLEXI PRO

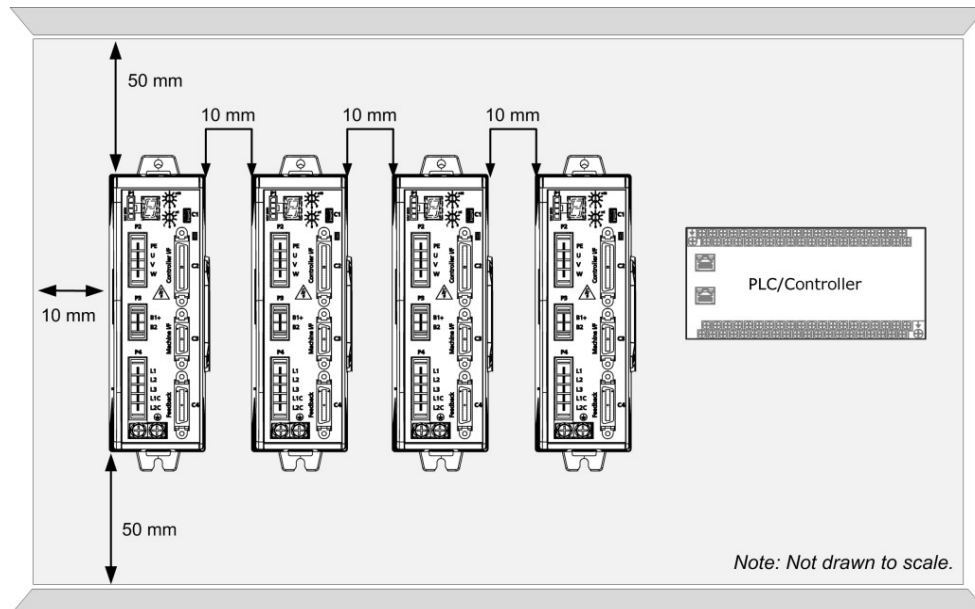
Using the bracket on the back of the FLEXI PRO, mount the FLEXI PRO on a grounded conductive metal panel. The panel must be sufficiently rigid.

For mounting dimensions, refer to Figure 3-1.

### 5.5.2 Mounting Multiple Units

When multiple FLEXI PRO units are mounted side-by-side within a cabinet or enclosure, the recommended minimum spacing between units is 10 mm. The recommended top and bottom clearance is 50 mm for all FLEXI PRO models.

It is important to maintain an ambient temperature within the enclosure that does not exceed 45°C. If FLEXI PRO units are mounted on a backplane, also make sure the backplane temperature does not exceed 45°C. It is recommended that a cooling fan be installed at the bottom of the cabinet for best circulation.



**Figure 5-5. Mounting Multiple FLEXI PRO Units within Cabinet**

## 5.6 Control Board Connections

The control board interfaces vary depending on the specific FLEXI PRO model, as detailed in the following table.

The connectors for interfaces C2, C3 and C4 can be fastened by either latch or screw. The FLEXI PRO has 4/40 insert threads on these interfaces.

**Table 5-2. Control Board Interfaces**

Function	Interface	AP	AF	EB	EC
USB Serial Communication	C1	–	■	■	■
RS232 Serial Communication	C7	■	■	–	■
Controller	C2	■	■	■	■
Pulse and direction input	C2	■	■	–	■
Analog output	C2	■	■	–	■
Machine	C3	■	■	–	■
Secondary feedback input	C3	■	■	–	■
Fault relay	C3	■	■	–	■
Motor Feedback	C4	■	■	■	■
Equivalent encoder output	C4	■	■	–	■
Motor feedback 8V supply	C4	■	–	–	■
Motor feedback resolver	C4	■	■	–	■
Fieldbus Devices	C5 + C6	–	■	■	■
Daisy Chain	C8	■	■	–	■
Drive Address	Rotary Switches	■	■	–	■

**Note:** Interfaces C3 and C4 on **PB** models are used for Motor Brake. Refer to section *Motor Brake on Power Block*.

### 5.6.1 Controller Interface – C2

**Controller I/Os** are connected through interface **C2**.

Wire the digital and analog inputs and outputs according to the requirements of your application.

Unused pins must remain unwired.

#### **PB Models – Controller**

This interface is used for the PWM communication with the controller.

For C2 pin descriptions, refer to the master controller documentation.

Wire the controller inputs and outputs according to the requirements of your application. Unused pins must remain unwired.

## AP/AF Models – Controller

To preserve isolation of the digital I/Os, connect a 24 VDC source to pin 19. Connect the return of the 24 VDC supply to pin 1, which functions as the ground path for the outputs.

**Note:** The 24 VDC supply and return can be connected on either the Controller interface (C2) or the Machine interface (C3), but it is not necessary to connect it on both.

Outputs are opto-isolated, and can be connected as sink only; outputs are compatible with source inputs.

Inputs can be connected as source only; inputs are compatible with sink outputs.

## EC Models – Controller

Common output on the Controller interface (C2) and the Machine interface (C3) are connected internally.

Common input on the Controller interface (C2) and the Machine interface (C3) are connected internally.

Outputs can be connected as either source or sink.

Inputs can be connected as either as source or sink.

Refer to the Controller Interface Wiring schematic diagram for **EC Models** in the section *Controller Interface Wiring*, and the FLEXI PRO System Wiring – Pin Assignments diagram for **EC Models** in the section *Wiring and Pin Assignments*.

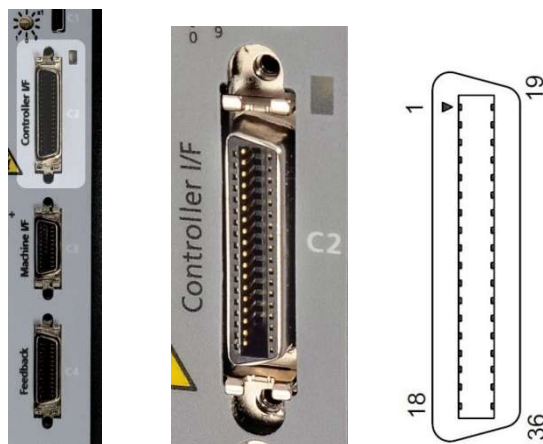
## EB Models – Controller

Outputs can be connected as either source or sink.

Inputs can be connected as either as source or sink.

Refer to the Controller Interface Wiring schematic diagram for **EB Models** in the section *Controller Interface Wiring*, and the FLEXI PRO System Wiring – Pin Assignments diagram for **EB Models** in the section *Wiring and Pin Assignments*.

## Controller I/Os – Interface and Pin Assignments



**Figure 5-6. Controller I/F Interface**

Refer to the controller interface wiring diagram in Figure 4-28.

**Table 5-3. Controller Interface – AP/AF Models**

Pin	Function	Description	Pin	Function	Description
1	24 VDC return	Return of the user-supplied 24 VDC	19	24 VDC	User supplied 24V, for I/O biasing
2	Digital output 1	Opto-isolated programmable digital output. Read using OUT1	20	Digital input 2	Opto-isolated programmable digital input. Read using IN2
3	Digital input 1	Opto-isolated programmable digital input. Read using IN1	21		
4	Equivalent encoder output A-	Low side of the equivalent encoder output signal A (RS422)	22	Equivalent encoder output A+	High side of the equivalent encoder output signal A (RS422)
5	Equivalent encoder output B-	Low side of the equivalent encoder output signal B (RS422)	23	Equivalent encoder output B+	High side of the equivalent encoder output signal B (RS422)
6	Equivalent encoder output Z-	Low side of the equivalent encoder output index (RS422)	24	Equivalent encoder output Z+	High side of the equivalent encoder output index (RS422)
7			25	Ground	Digital ground
8	Analog input 1+	High side of the differential analog command input ( $\pm 10$ VDC)	26	Analog input 1-	Low side of the differential analog command input ( $\pm 10$ VDC)
9	Direction input+	High side of the direction signal (RS422), or High side of the down count signal	27	Direction input-	Low side of the direction signal (RS422), or Low side of the down count signal
	Secondary encoder B+	High side of the Secondary encoder input signal B (RS422)		Secondary encoder B-	Low side of the secondary encoder input signal B (RS422)
10	Ground	Digital ground	28	Pulse input+	High side of the pulse signal (RS422), or High side of the master encoder signal A, or High side of the up count signal
			Secondary encoder A+	High side of the secondary encoder input signal A (RS422)	
11	Pulse input-	Low side of the pulse signal (RS422), or Low side of the master encoder signal A, or Low side of the up count signal	29	Ground	Digital ground
	Secondary encoder A-	Low side of the secondary encoder input signal A (RS422)			
12			30		
13	Ground	Digital ground	31	Digital input 3	Opto-isolated programmable digital input. Read using IN3
14	Digital input 4	Opto-isolated programmable digital input. Read using IN4	32	Digital input 5	Fast opto-isolated programmable digital input. Read using IN5
15	Digital input 6	Fast opto-isolated programmable digital input. Read using IN6	33	Digital output 2	Opto-isolated programmable digital output. Read using OUT2
16	Digital output 3	Fast opto-isolated programmable digital output. Read using OUT3	34		

Pin	Function	Description	Pin	Function	Description
17			35*	Analog input 2-	Low side of the second differential analog input ( $\pm 10$ VDC)
18*	Analog input 2+	High side of the second differential analog input ( $\pm 10$ VDC)	36	Analog output	Analog output, referenced to digital ground (0-10 VDC)

\* Optional, see ordering information. Blank cells indicate unused pins; these pins must remain unwired.

**Table 5-4. Controller Interface – EC Models**

Pin	Function	Description	Pin	Function	Description
1	Common output		19	Common input	
2	Digital output 1	Opto-isolated programmable digital output. Read using OUT1	20	Digital input 2	Opto-isolated programmable digital input. Read using IN2
3	Digital input 1	Opto-isolated programmable digital input. Read using IN1	21		
4	Equivalent encoder output A-	Low side of the equivalent encoder output signal A (RS422)	22	Equivalent encoder output A+	High side of the equivalent encoder output signal A (RS422)
5	Equivalent encoder output B-	Low side of the equivalent encoder output signal B (RS422)	23	Equivalent encoder output B+	High side of the equivalent encoder output signal B (RS422)
6	Equivalent encoder output Z-	Low side of the equivalent encoder output index (RS422)	24	Equivalent encoder output Z+	High side of the equivalent encoder output index (RS422)
7			25	Ground	Digital ground
8	Analog input 1+	High side of the differential analog command input ( $\pm 10$ VDC)	26	Analog input 1-	Low side of the differential analog command input ( $\pm 10$ VDC)
9	Direction input+	High side of the direction signal (RS422), or High side of the down count signal	27	Direction input-	Low side of the direction signal (RS422), or Low side of the down count signal
	Secondary encoder B+	High side of the Secondary encoder input signal B (RS422)		Secondary encoder B-	Low side of the secondary encoder input signal B (RS422)
10	Ground	Digital ground	28	Pulse input+	High side of the pulse signal (RS422), or High side of the master encoder signal A, or High side of the up count signal
				Secondary encoder A+	High side of the secondary encoder input signal A (RS422)
11	Pulse input-	Low side of the pulse signal (RS422), or Low side of the master encoder signal A, or Low side of the up count signal	29	Ground	Digital ground
	Secondary encoder A-	Low side of the secondary encoder input signal A (RS422)			
12			30		
13	Ground	Digital ground	31	Digital input 3	Opto-isolated programmable digital input. Read using IN3
14	Digital input 4	Opto-isolated programmable digital input. Read using IN4	32	Digital input 5	Fast opto-isolated programmable digital input. Read using IN5

Pin	Function	Description	Pin	Function	Description
15	Digital input 6	Fast opto-isolated programmable digital input. Read using IN6	33	Digital output 2	Opto-isolated programmable digital output. Read using OUT2
16	Digital output 3	Fast opto-isolated programmable digital output. Read using OUT3	34		
17			35*	Analog input 2-	Low side of the second differential analog input ( $\pm 10$ VDC)
18*	Analog input 2+	High side of the second differential analog input ( $\pm 10$ VDC)	36	Analog output	Analog output, referenced to digital ground (0-10 VDC)

\* Optional, see ordering information. Blank cells indicate unused pins; these pins must remain unwired.

**Table 5-5. Controller Interface – EB Models**

Pin	Function	Description	Pin	Function	Description
1	Common output		19	Common input	
2	Digital output 1	Opto-isolated programmable digital output. Read using OUT1	20	Digital input 2	Opto-isolated programmable digital input. Read using IN2
3	Digital input 1	Opto-isolated programmable digital input. Read using IN1	21		
4			22		
5			23		
6			24		
7			25	Ground	Digital ground
8	Analog input 1+	High side of the differential analog command input ( $\pm 10$ VDC)	26	Analog input 1-	Low side of the differential analog command input ( $\pm 10$ VDC)
9			27		
10	Ground	Digital ground	28		
11			29	Ground	Digital ground
12			30		
13	Ground	Digital ground	31	Digital input 3	Opto-isolated programmable digital input. Read using IN3
14	Digital input 4	Opto-isolated programmable digital input. Read using IN4	32	Digital input 5	Fast opto-isolated programmable digital input. Read using IN5
			33	Digital output 2	Opto-isolated programmable digital output. Read using OUT2
16	Digital output 3	Opto-isolated programmable digital output. Read using OUT3	34		
17			35	Analog input 2-	Low side of the second differential analog input ( $\pm 10$ VDC)
18	Analog input 2+	High side of the second differential analog input ( $\pm 10$ VDC)	36		

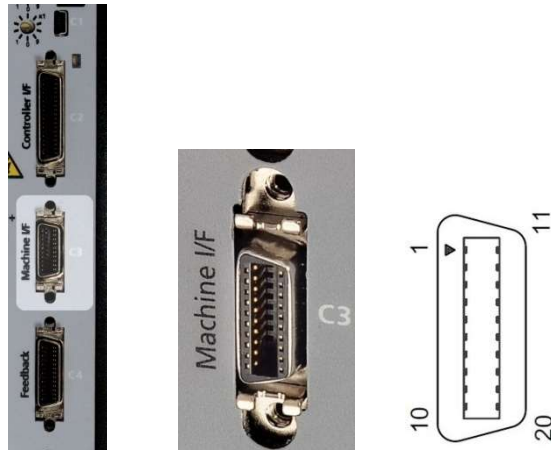
Blank cells indicate unused pins; these pins must remain unwired.

## 5.6.2 Machine Interface – C3

**Machine I/Os** are connected through interface **C3**.

Wire the machine inputs and outputs according to the requirements of your application.

Unused pins must remain unwired.



**Figure 5-7. Machine I/O Interface**

Refer to the machine interface wiring diagram in Figure 4-31.

### PB Models – Machine I/Os

FLEXI PRO **PB** models do not have a Machine I/F interface.

### AP/AF Models – Machine I/Os

To preserve isolation of the digital I/Os, connect a 24 VDC source to pin 9. Connect the return of the 24 VDC supply to pin 19, which functions as the ground path for the outputs.

**Note:** The 24 VDC supply and return can be connected on either the Controller interface (C2) or the Machine interface (C3), but it is not necessary to connect it to both.

### EC Models – Machine I/Os

Common output on the Controller interface (C2) and the Machine interface (C3) are connected internally.

Common input on the Controller interface (C2) and the Machine interface (C3) are connected internally.

User can connect outputs as source or sink.

User can connect inputs as source or sink.

Refer to the Machine Interface Wiring schematic diagram for **EC Models** in the section *Machine Interface Wiring*, and the FLEXI PRO System Wiring – Pin Assignments diagram for **EC Models** in section *Wiring and Pin Assignments*.

### EB Models – Machine I/Os

FLEXI PRO **EB** models do not have a Machine I/F interface.

## Machine I/Os – Interface and Pin Assignments

**Table 5-6. Machine I/O Interface**

Pin	Function	Description	Pin	Function	Description
1	Secondary encoder A+	High side of the secondary encoder input signal A (RS422)	11	Secondary encoder A-	Low side of the secondary encoder input signal A (RS422)
	Pulse input+	High side of the pulse signal		Pulse input-	Low side of the pulse signal
2	Secondary encoder B+	High side of the Secondary encoder input signal B (RS422)	12	Secondary encoder B-	Low side of the secondary encoder input signal B (RS422)
	Direction input+	High side of the direction signal		Direction input-	Low side of the direction signal
3	Secondary encoder Z+	High side of the secondary encoder input index (RS422)	13	Secondary encoder Z-	Low side of the secondary encoder input index (RS422)
4	Secondary encoder 5V	5 VDC supply for the secondary encoder	14	Secondary encoder ground	Ground of the 5 VDC supply for the secondary encoder.
5	Digital input 7	Opto-isolated programmable digital input. Read using IN7	15	Digital input 8	Opto-isolated programmable digital input. Read using IN8
6	Digital input 9	Opto-isolated programmable digital input. Read using IN9	16	Digital input 10	Opto-isolated programmable digital input. Read using IN10
7	Digital input 11	Fast opto-isolated programmable digital input. Read using IN11	17	Digital output 4	Opto-isolated programmable digital output. Read using OUT4
8	Digital output 5	Opto-isolated programmable digital output. Read using OUT5	18	Digital output 6	Fast opto-isolated programmable digital output. Read using OUT6
9	24 VDC	AP/AF Models: User supplied 24V, for I/O biasing	19	24 VDC return	AP/AF Models: Return of the user-supplied 24 VDC
	Common input	EC Models		Common output	EC Models
10	Fault relay 1	Terminal 1 of the dry contact fault relay	20	Fault relay 2	Terminal 2 of the dry contact fault relay



### 5.6.3 Motor Feedback – C4

**Motor Feedback** uses interface **C4**.

Wire the motor feedback interface according to the type of feedback device to be used in your application. Refer to the guidelines following the pinout table below.

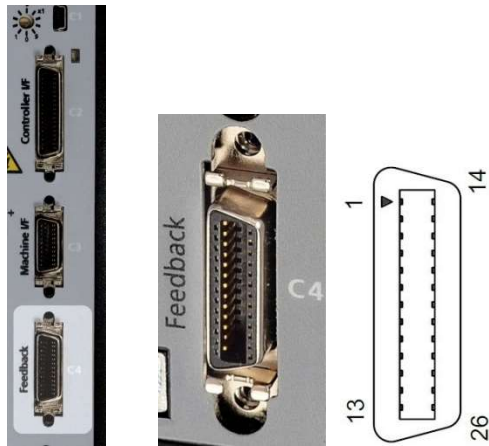
Pins 1, 2, 14 and 15 have dual functionality.

Pin 25 for the motor temperature sensor is connected internally in the drive to FLEXI PRO ground.

Unused pins must remain unwired.

**Notes** regarding serial communication encoders, such as Tamagawa and Nikon:

- Serial encoder data is bidirectional.
- Serial encoder clock is only output.
- Low-voltage indication comes directly from the encoder; the drive does not have the capability to verify encoder battery voltage.



**Figure 5-8. Motor Feedback Interface**

#### **PB Models – Motor Feedback**

FLEXI PRO **PB** models do not have a Machine I/F interface.

## AP Models – Motor Feedback

**Table 5-7. Motor Feedback Interface – AP Models**

Pin	Function	Pin	Function
1	Incremental encoder A +	14	Incremental encoder A -
	Serial encoder data +		Serial encoder data -
2	Incremental encoder B +	15	Incremental encoder B -
	Serial encoder clock +		Serial encoder clock -
3	Incremental Encoder Z +	16	Incremental encoder Z -
4	Hall U +	17	Hall V+
5	Hall W +	18	
6	Resolver sine +	19	Resolver sine -
7	Resolver cosine +	20	Resolver cosine -
8	Resolver reference +	21	Resolver reference -
9	Sine encoder sine +	22	Sine encoder sine -
10	Sine encoder cosine +	23	Sine encoder cosine -
11	5V supply	24	Ground (5V/8V return)
12	Motor temperature sensor	25	Motor temperature sensor
13	5V supply	26	Shield

## AF/EC Models – Motor Feedback

**Table 5-8. Motor Feedback Interface – AF/EC Models**

Pin	Function	Pin	Function
1	Incremental encoder A +	14	Incremental encoder A -
	Serial encoder data +		Serial encoder data -
2	Incremental encoder B +	15	Incremental encoder B -
	Serial encoder clock +		Serial encoder clock -
3	Incremental Encoder Z +	16	Incremental encoder Z -
4	Hall U +	17	Hall V+
5	Hall W +	18	8V supply
6	Resolver sine +	19	Resolver sine -
7	Resolver cosine +	20	Resolver cosine -
8	Resolver reference +	21	Resolver reference -
9	Sine encoder sine +	22	Sine encoder sine -
10	Sine encoder cosine +	23	Sine encoder cosine -
11	5V supply	24	Ground (5V/8V return)
12	Motor temperature sensor	25	Motor temperature sensor
13	5V supply	26	Shield

## EB Models – Motor Feedback

**Table 5-9. Motor Feedback Interface – EB Models**

Pin	Function	Pin	Function
1	Incremental encoder A + Serial encoder data +	14	Incremental encoder A - Serial encoder data -
2	Incremental encoder B + Serial encoder clock +	15	Incremental encoder B - Serial encoder clock -
3	Incremental Encoder Z +	16	Incremental encoder Z -
4	Hall U +	17	Hall V+
5	Hall W +	18	
6		19	
7		20	
8		21	
9	Sine encoder sine +	22	Sine encoder sine -
10	Sine encoder cosine +	23	Sine encoder cosine -
11	5V supply	24	Ground (5V/8V return)
12	Motor temperature sensor	25	Motor temperature sensor
13	5V supply	26	Shield

### 5.6.4 Motor Feedback Wiring Tables

The following tables present suggestions for the most common feedback variations. If you need additional information, or your motor feedback does not match any one of the following, contact Technical Support.

The tables present the wiring pin layout. Use the **User Motor Pin#** column in these tables to record the pin numbers of your specific motor for future reference.

Use the Flexi SUITE **Motor Setup** procedure and the **Feedback** screens to define motor feedback type, resolution, and other parameters.

### Wiring – sensAR Encoder

**Table 5-10. Feedback Wiring – sensAR Encoder**

Pin #	Twisted Pair	User Motor Pin#	Signal Description
1	Twisted Pair		Serial Data +
14			Serial Data -
11			+5 VDC
24			0 VDC
26			Shield

## Wiring – BiSS-C Encoder

**Table 5-11. BiSS-C Encoder**

Pin #	Twisted Pair	User Motor Pin#	Signal Description
1	Twisted Pair		Serial Data + (SLO+)
14			Serial Data - (SLO-)
2	Twisted Pair		Serial Clock + (MA+)
15			Serial Clock - (MA-)
11			+5 VDC
24			0 VDC
26			Shield

## Wiring – Incremental Encoder A Quad B, Index Pulse and Halls

**Table 5-12. Feedback Wiring – Incremental Encoder A Quad B, Index Pulse and Halls**

Pin #	Twisted Pair	User Motor Pin#	Signal Description
1	Twisted Pair		Incremental Encoder A+
14			Incremental Encoder A-
2	Twisted Pair		Incremental Encoder B+
15			Incremental Encoder B-
3	Twisted Pair		Incremental Encoder Z+
16			Incremental Encoder Z-
4			Hall U
17			Hall V
5			Hall W
12	Twisted Pair		Motor Temperature Sensor
25			Motor Temperature Sensor
11			+5 VDC
24			0 VDC
26			Shield

**Notes:** If the motor does not support a temperature sensor, do not connect pins 12 and 25.

## Wiring – Single-Ended Halls

**Table 5-13. Feedback Wiring – Single-Ended Halls**

Pin #	Twisted Pair	User Motor Pin#	Signal Description
4			Hall U
17			Hall V
5			Hall W
11			+5 VDC
24			0 VDC
12	Twisted Pair		Motor Temperature Sensor
25			Motor Temperature Sensor
26			Shield

**Notes:** If the motor does not support a temperature sensor, do not connect pins 12 and 25.

Halls are single-ended signals. If you want to use differential Hall signals, refer to the relevant wiring tables.

## Wiring – Incremental Encoder A Quad B, Index Pulse and Differential Halls

**Table 5-14. Feedback Wiring – Incremental Encoder A Quad B, Index Pulse and Differential Halls**

Pin #	Twisted Pair	User Motor Pin#	Signal Description
1	Twisted Pair		Incremental Encoder A+
14			Incremental Encoder A-
2	Twisted Pair		Incremental Encoder B+
15			Incremental Encoder B-
9			Hall U+
22			Hall U-
10			Hall V+
23			Hall V-
3			Hall W+
16			Hall W-
12	Twisted Pair		Motor Temperature Sensor
25			Motor Temperature Sensor
11			+5 VDC
24			0 VDC
26			Shield

**Notes:** If the motor does not support a temperature sensor, do not connect pins 12 and 25.

To use differential Halls with A quad B and index, connect the Halls to the Machine interface as follows:

Hall U+ to Machine I/F pin 1, Hall U- to Machine I/F pin 11.

Hall V+ to Machine I/F pin 2, Hall V- to Machine I/F pin 12.

Hall W+ to Machine I/F pin 3, Hall W- to Machine I/F pin 13.

Connect the encoder A, B, I, and power supply to the Motor Feedback connector.

On every power up, phase find (PHASEFIND) must be executed.

## Wiring – Differential Halls Only

**Table 5-15. Feedback Wiring – Differential Halls Only**

Pin #	Twisted Pair	User Motor Pin#	Signal Description
9			Hall U+
22			Hall U-
10			Hall V+
23			Hall V-
3			Hall W+
16			Hall W-
12	Twisted Pair		Motor Temperature Sensor
25			Motor Temperature Sensor
11			+5 VDC
24			0 VDC
26			Shield

**Notes:** If the motor does not support a temperature sensor, do not connect pins 12 and 25.

## Wiring – Tamagawa Incremental

**Table 5-16. Feedback Wiring – Tamagawa Incremental**

Pin #	Twisted Pair	User Motor Pin#	Signal Description
1	Twisted Pair		Incremental Encoder A+ / Hall U+
14			Incremental Encoder A- / Hall U-
2	Twisted Pair		Incremental Encoder B+ / Hall V+
15			Incremental Encoder B- / Hall V-
3	Twisted Pair		Incremental Encoder Z+ / Hall W+
16			Incremental Encoder Z- / Hall W-
12	Twisted Pair		Motor Temperature Sensor
25			Motor Temperature Sensor
11			+5 VDC
24			0 VDC
26			Shield

**Notes:** If the motor does not support a temperature sensor, do not connect pins 12 and 25.

Incremental encoders with Hall sensors and index pulse.

A, B and Z signals use the same wiring as Hall sensors U, V, and W. On power up, feedback briefly sends Hall readings, and then continuously sends the A, B and Z signals.

On every power up, phase find (PHASEFIND) must be executed.

## Wiring – Sine Encoder

**Table 5-17. Feedback Wiring – Sine Encoder**

Pin #	Twisted Pair	User Motor Pin#	Signal Description
9	Twisted Pair		Sine Encoder Sine+
22			Sine Encoder Sine-
10	Twisted Pair		Sine Encoder Cosine+
23			Sine Encoder Cosine-
12	Twisted Pair		Motor Temperature Sensor
25			Motor Temperature Sensor
11			+5VDC
24			0VDC
26			Shield

**Notes:** If the motor does not support a temperature sensor, do not connect pins 12 and 25.

On every power up, phase find (PHASEFIND) must be executed.

## Wiring – Sine Encoder with Halls

**Table 5-18. Feedback Wiring – Sine Encoder with Halls**

Pin #	Twisted Pair	User Motor Pin#	Signal Description
9	Twisted Pair		Sine Encoder Sine+
22			Sine Encoder Sine-
10	Twisted Pair		Sine Encoder Cosine+
23			Sine Encoder Cosine-
4			Hall U
17			Hall V
5			Hall W
12	Twisted Pair		Motor Temperature Sensor
25			Motor Temperature Sensor
11			+5 VDC
24			0 VDC
26			Shield

**Note:** If the motor does not support a temperature sensor, do not connect pins 12 and 25.



## Wiring – Sine Encoder with Index

**Table 5-19. Feedback Wiring – Sine Encoder with Index**

Pin #	Twisted Pair	User Motor Pin#	Signal Description
9	Twisted Pair		Sine Encoder Sine+
22			Sine Encoder Sine-
10	Twisted Pair		Sine Encoder Cosine+
23			Sine Encoder Cosine-
3	Twisted Pair		Sine Encoder Z+
16			Sine Encoder Z-
12	Twisted Pair		Motor Temperature Sensor
25			Motor Temperature Sensor
11			+5 VDC
24			0 VDC
26			Shield

**Note:** If the motor does not support a temperature sensor, do not connect pins 12 and 25.

## Wiring – Sine Encoder with Index and Halls

**Table 5-20. Feedback Wiring – Sine Encoder with Index and Halls**

Pin #	Twisted Pair	User Motor Pin#	Signal Description
9	Twisted Pair		Sine Encoder Sine+
22			Sine Encoder Sine-
10	Twisted Pair		Sine Encoder Cosine+
23			Sine Encoder Cosine-
3	Twisted Pair		Sine Encoder Z+
16			Sine Encoder Z-
4			Hall U
17			Hall V
5			Hall W
12	Twisted Pair		Motor Temperature Sensor
25			Motor Temperature Sensor
11			+5 VDC
24			0 VDC
26			Shield

**Note:** If the motor does not support a temperature sensor, do not connect pins 12 and 25.

## Wiring – Sick 5V (HIPERFACE Protocol and Sine Signal)

**Table 5-21. Feedback Wiring – Sick 5V (HIPERFACE Protocol and Sine Signal)**

Pin #	Twisted Pair	User Motor Pin#	Signal Description
1	Twisted Pair		Serial Data +
14			Serial Data -
9	Twisted Pair		Sine Encoder Sine+
22			Sine Encoder Sine-
10	Twisted Pair		Sine Encoder Cosine+
23			Sine Encoder Cosine-
12	Twisted Pair		Motor Temperature Sensor
25			Motor Temperature Sensor
11			+5 VDC
24			0 VDC
26			Shield

**Note:** If the motor does not support a temperature sensor, do not connect pins 12 and 25.

## Wiring – Sick 8V (HIPERFACE Protocol and Sine Signal)

**Table 5-22. Feedback Wiring – Sick 8V (HIPERFACE Protocol and Sine Signal)**

Pin #	Twisted Pair	User Motor Pin#	Signal Description
1	Twisted Pair		Serial Data +
14			Serial Data -
9	Twisted Pair		Sine Encoder Sine+
22			Sine Encoder Sine-
10	Twisted Pair		Sine Encoder Cosine+
23			Sine Encoder Cosine-
12	Twisted Pair		Motor Temperature Sensor
25			Motor Temperature Sensor
18			+8 VDC
24			0 VDC
26			Shield

**Note:** If the motor does not support a temperature sensor, do not connect pins 12 and 25.

## Wiring – HEIDENHAIN (EnDat 2.x Communication Only)

**Table 5-23. Feedback Wiring – HEIDENHAIN (EnDat 2.x Communication Only)**

Pin #	Twisted Pair	User Motor Pin#	Signal Description
1	Twisted Pair		Serial Data +
14			Serial Data -
2	Twisted Pair		Serial Clock +
15			Serial Clock -
12	Twisted Pair		Motor Temperature Sensor
25			Motor Temperature Sensor
11			+5 VDC
24			0 VDC
26			Shield

**Note:** If the motor does not support a temperature sensor, do not connect pins 12 and 25.

Refer to the section *EnDat 2.2 Bidirectional Interface*.

## Wiring – HEIDENHAIN (EnDat 2.x with Sine/Cosine)

**Table 5-24. Feedback Wiring – HEIDENHAIN (EnDat 2.x with Sine/Cosine)**

Pin #	Twisted Pair	User Motor Pin#	Signal Description
1	Twisted Pair		Serial Data +
14			Serial Data -
2	Twisted Pair		Serial Clock +
15			Serial Clock -
9	Twisted Pair		Sine Encoder Sine+
22			Sine Encoder Sine-
10	Twisted Pair		Sine Encoder Cosine+
23			Sine Encoder Cosine-
11			+5 VDC
24			0 VDC
26			Shield

**Note:** If the motor does not support a temperature sensor, do not connect pins 12 and 25.

Refer to the section *EnDat 2.2 Bidirectional Interface*.

## Wiring – Nikon / Tamagawa | Incremental 17-bit | Single Turn

**Table 5-25. Feedback Wiring – Single Turn: Nikon 17-bit Single Turn | Tamagawa 17-bit Incremental Single Turn**

Pin #	Twisted Pair	User Motor Pin#	Signal Description
1	Twisted Pair		Serial Data +
14			Serial Data -
11			+5 VDC
24			0 VDC
26			Shield

**Note:** The motor temperature is available on the serial data; there is no need for pins 12 and 25.

## Wiring – Nikon / Tamagawa | Incremental 17-bit | Multi-Turn

**Table 5-26. Feedback Wiring – Multi-turn: Nikon 17-bit Multi-turn | Tamagawa 17-bit Multi-turn | Sankyo Multi-turn**

Pin #	Twisted Pair	User Motor Pin#	Signal Description
1	Twisted Pair		Serial Data +
14			Serial Data -
11			+5 VDC
24			0 VDC
26			Shield
			Battery Voltage
			Battery Ground

**Notes:** The motor temperature is available on the serial data; there is no need for pins 12 and 25.

Encoder backup battery is external to the FLEXI PRO drive. Voltage must be more than 3.6 VDC. Suggested battery is lithium 3.6V, 1000mAh.

Use the backup battery recommended by the encoder manufacturer.

## Wiring – Resolver

**Table 5-27. Feedback Wiring – Resolver**

Pin #	Twisted Pair	User Motor Pin#	Signal Description
6	Twisted Pair		Resolver Sine +
19			Resolver Sine -
7	Twisted Pair		Resolver Cosine +
20			Resolver Cosine -
8	Twisted Pair		Resolver Reference +
21			Resolver Reference -
12	Twisted Pair		Motor Temperature Sensor
25			Motor Temperature Sensor
24	Ground		Optional: Internal shield of each twisted pair (sine, cosine, reference)
26			Cable Shield

**Notes:** If the motor does not support a temperature sensor, do not connect pins 12 and 25.

Halls are single-ended signals. If you want to use differential Hall signals, refer to the relevant wiring tables.

### 5.6.5 Motor Brake on Power Block



**Figure 5-9. Motor Brake Ports**

#### C3 - Motor Brake Control

The interface is labeled **C3** on all PB models (power blocks) .

**Table 5-28. Motor Brake Control Interface**

Pin	Pin Label	Function
1	BR+	Motor Brake (+)
2	BR-	Motor Brake (-)
3		Not connected

**Table 5-29. Motor Brake Control Mating Connector**

Item	All Models
Manufacturer	Molex*
Housing and 4-pin crimp	436450300* and 0430300001*
Wire gauge	26–28 AWG

\* Or equivalent.

## C4 - Motor Brake 24 VDC Input

The interface is labeled **C4** on all PB models (power blocks).

**Table 5-30. Motor Brake 24 VDC Input Interface**

Pin	Pin Label	Function
1	24VIN	+24V DC
2	24RTN	-24V DC

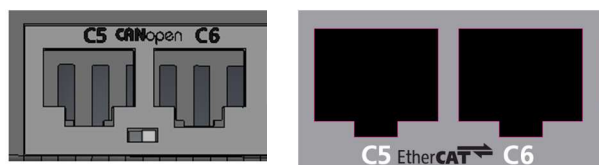
**Table 5-31. Motor Brake 24 VDC Input Mating Connector**

Item	All Models
Manufacturer	Molex*
Housing and 4-pin crimp	436450200* and 0430300001*
Spring terminal	Not available
Wire gauge	26–28 AWG

\* Or equivalent.

## 5.6.6 Fieldbus Devices – C5 and C6

Interfaces **C5** and **C6** are RJ45 ports that serve as transmitter (Tx) and receiver (Rx) for drives operating on a CAN or Ethernet network.

**Figure 5-10. Fieldbus Communication Ports**

The LEDs on interfaces C5 and C6 indicate fieldbus status. Refer to the section *Fieldbus Status – LEDs*.

Refer to the *FLEXI PRO EtherCAT and CANopen Reference Manual* for details on installation, configuration and operation of drives being used on CAN and EtherCAT networks.

An adapter is available to enable the connection of a RJ45 port to a D9 interface. Refer to the section *D9-RJ45 Adapter*.

### 5.6.7 Host Computer – C1 and/or C7

The drive can be connected to the host computer through either one of the following interfaces:

- USB port.** The interface is labeled **C1**  
*(Exception: AP models do not have a USB port.)*  
 Use a USB 2.0 A to Mini-B cable.

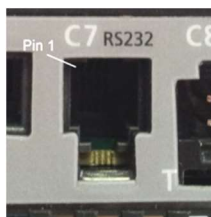


**Figure 5-11. USB Port**

The first time the drive is connected to the host computer on the USB port, Windows may detect the device and display a **Found New Hardware** wizard.

**Note:** 64-bit editions of Windows require digitally signed drivers. FLEXI PRO software includes an unsigned USB driver. To install the USB driver, you must first disable driver signature verification ([Example](#)).

- RS232 port.** The interface is labeled **C7**.  
*(Exception: EB models do not have an RS232 port.)*  
 Use a 4p4c plug.



**Figure 5-12. RS232 Port**

**Table 5-32. RS232 Interface**

Pin	Pin Label	Function
1	<b>RX</b>	Receive
2	<b>GND ISO</b>	Ground
3	<b>TX</b>	Transmit
4		Unused

## 5.6.8 Daisy Chain – C8

**Note:** **EB** models do not have Daisy Chain port.

The FLEXI PRO can be addressed and controlled on a daisy-chained RS232 line.

In a daisy-chain RS232 configuration, all drives must be daisy-chained through the **C8** connector. Each drive must have a unique address to enable its identification on the network.

A daisy-chained drive can be assigned an address from 1 to 99 by setting the rotary switches on the drive. When configuring a daisy-chain, address 0 cannot be used.



**Figure 5-13. Daisy Chain Port**

**Table 5-33. Daisy Chain Interface**

Pin	Function
1	DC Shield
2	Unused
3	RXD
4	GND
5	TXD
6	GND
7-10	Unused

## 5.6.9 Drive Address – Rotary Switch

**Note:** **EB** models do not have rotary switches.

The FLEXI PRO has two 10-position rotary switches, accessible from the front of the unit. The switches are used to set the drive address. When there is more than one drive on a daisy-chain or CANbus network, each drive must have a unique address to enable its identification on the network.

Use the two rotary switches to set the drive address for both CAN and serial communication.

For Ethernet-based motion buses, the switch has no functional use for either the drive or the network. It can be used at the application level to identify specific drives on a network.

Each switch has 10 positions:

- The upper switch positions are set as tens: 10, 20, 30 ... 90
- The lower switch positions are set as ones: 0, 1, 2 ... 9

**Notes:** If two or more drives are connected to the network, address 0 cannot be used. Only a singular drive may have the address 0.

Two drives in the same network cannot have the same address.





Figure 5-14. Drive Address Rotary Switches

## 5.7 Power Board Connections – 120/240 VAC

On most FLEXI PRO 120/240 VAC models, the power board has the following interfaces:

- STO – P1
- Motor – P2 (P4 on FLEXI PRO-020/024)
- Regeneration Resistor – P3 (P5 on FLEXI PRO-020/024)
- AC Input Voltage – P3, P4 (P2, P3 on FLEXI PRO-020/024)



**Make sure the main voltage rating matches the drive specification. Applying incorrect voltage may cause drive failure.**

**Do not apply power until all hardware connections are complete.**

### 5.7.1 STO

**STO** uses interface **P1** on all FLEXI PRO 120/240 models.

Safe torque off (STO) is a safety function that prevents the drive from delivering power to the motor, which can generate torque.

For complete installation and operation details, refer to the *FLEXI PRO Functional Safety Reference Guide*.

**Note:** If the application does not require STO control, jumper pin 4 to pin 1, and pin 3 to pin 2, to bypass the STO.

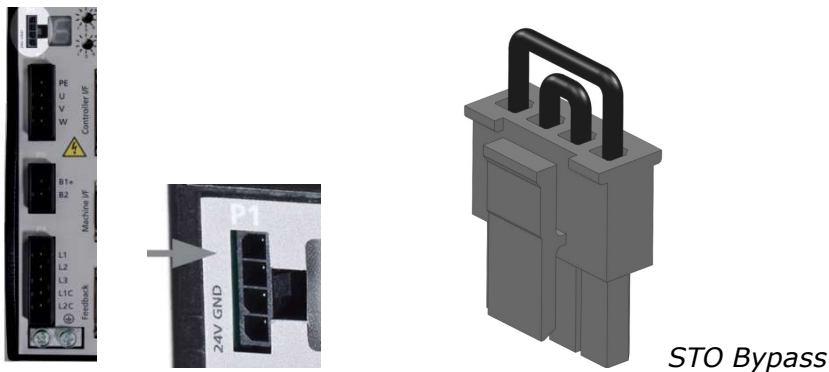


Figure 5-15. STO Interface

**Table 5-34. STO Interface**

Pin	Pin Label	Function
1	<b>24V</b>	STO Enable
2	<b>GND</b>	STO Return
3		24V Return, provided by the drive for use with emergency stop circuit
4		24V Supply, provided by the drive for use with emergency stop circuit

**Table 5-35. STO Interface Mating Connector**

Item	All Models
Manufacturer	Molex*
Housing and 4-pin crimp	436450400* and 0430300001*
Spring terminal	Not available
Wired STO	Motor Power Company CONr00000004-AS (supplied)
Wire gauge	26–28 AWG

\* Or equivalent.

## 5.7.2 Motor

**Motor** uses interface **P2** on all FLEXI PRO 120/240 models.

*Exception:* **Motor** uses **P4** on FLEXI PRO-020/024.

Connect the motor interface.

**Figure 5-16. Motor Interface (shown here: FLEXI PRO-006)****Table 5-36. Motor Interface**

Pin	Pin Label	Function
1	<b>PE</b>	Functional Ground (motor housing)
2	<b>U</b>	Motor Phase U
3	<b>V</b>	Motor Phase V
4	<b>W</b>	Motor Phase W

**Table 5-37. Motor Interface Mating Connectors**

<b>Item</b>		<b>FLEXI PRO-1D5, FLEXI PRO-003</b>
Manufacturer		JST J300
Housing and 4-pin crimp		F32FSS-04V-KX and SF3F-71GF-P2.0
Spring terminal		04JFAT-SBXGF-I (supplied)
Wire gauge		18 AWG
<b>Item</b>		<b>FLEXI PRO-4D5, FLEXI PRO-006</b>
Manufacturer		JST J300
Housing and 4-pin crimp		F32FSS-04V-KX and SF3F-71GF-P2.0
Spring terminal		04JFAT-SBXGF-I (supplied)
Wire gauge		16 AWG
<b>Item</b>		<b>FLEXI PRO-008, FLEXI PRO-010, FLEXI PRO-013</b>
Manufacturer		JST J400
Housing and 4-pin crimp		J43FSS-04V-KX (supplied) and SJ4F-71GF-M3.0 (supplied)
Spring terminal		Not available
Wire gauge		14 AWG
<b>Item</b>		<b>FLEXI PRO-020, FLEXI PRO-024</b>
Manufacturer		Phoenix Contact
Spring terminal		SPC 5/4-STCL-7,62 (1718504) (supplied)
Wire gauge		10-11 AWG

### 5.7.3 Regeneration Resistor

**Regen** uses interface **P3** on all FLEXI PRO 120/240 VAC models.

*Exception:* **Regen** uses **P5** on FLEXI PRO-020/024.

**Note:** On models FLEXI PRO-1D5 and FLEXI PRO-003, **Regen** and **AC Input Voltage** are combined on one connector.

If the application requires a regeneration (regen) resistor, connect the regen resistor between terminals B1+ and B2.



**Figure 5-17. Regen Interface (shown here: FLEXI PRO-006)**

**Table 5-38. Regen Interface**

<b>FLEXI PRO-1D5, FLEXI PRO-003 FLEXI PRO-4D5, FLEXI PRO-006 FLEXI PRO-008, FLEXI PRO-010 FLEXI PRO-013</b>	<b>Pin</b>	<b>Pin Label</b>	<b>Function</b>
<b>P3</b>	1	<b>B1+</b>	DC bus +
	2	<b>B2</b>	Regen bus -
<b>FLEXI PRO-020, FLEXI PRO-024</b>	<b>Pin</b>	<b>Pin Label</b>	<b>Function</b>
<b>P5</b>	1	<b>B2</b>	Regen bus -
	2	<b>B1+</b>	DC bus +

**Table 5-39. Regen Interface Mating Connectors**

<b>Item</b>	<b>FLEXI PRO-4D5, FLEXI PRO-006</b>
Manufacturer	JST J300
Housing and 2-pin crimp	F32FSS-02V-KX (supplied) and SF3F71-GF-P2.0 (supplied)
Spring terminal	Not available
Wire gauge	16 AWG
<b>Item</b>	<b>FLEXI PRO-008, FLEXI PRO-010, FLEXI PRO-013</b>
Manufacturer	JST J400
Housing and 2-pin crimp	J42FSC-02V-KX (supplied) and SJ4F-71GF-M3.0 (supplied)
Spring terminal	Not available
Wire gauge	14 AWG
<b>Item</b>	<b>FLEXI PRO-020, FLEXI PRO-024</b>
Manufacturer	Phoenix Contact
Spring terminal	SPC 5/2-STCL-7,62 (1718504) (supplied)
Wire gauge	14 AWG

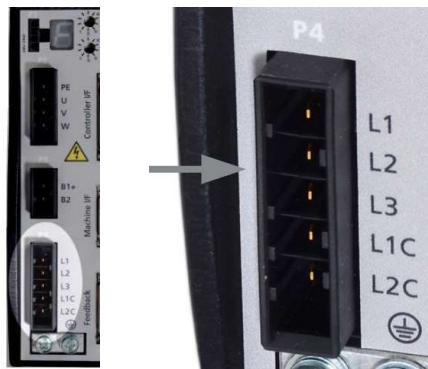
**Table 5-40. AC Input Voltage/Regen Interface Mating Connector**

Item	FLEXI PRO-1D5, FLEXI PRO-003
Manufacturer	JST J300
Housing and 6-pin crimp	F32FSS-06V-KX and SF3F-71GF-P2.0
Spring terminal	06JFAT-SBXGF-I (supplied)
Wire gauge	18 AWG

### 5.7.4 AC Input Voltage

The AC Input interfaces and connectors vary among FLEXI PRO 120/240 VAC models.

- FLEXI PRO-1D5 and FLEXI PRO-003: One connector for bus power and logic power uses interface **P3**.
- FLEXI PRO-4D5 and FLEXI PRO-006: One connector for bus power and logic power uses interface **P4**.
- FLEXI PRO-008, FLEXI PRO-010 and FLEXI PRO-013: Two connectors – a connector for bus power uses interface **P4**, and another connector for logic power uses interface **P5**.
- FLEXI PRO -020/024: Two connectors – a connector for bus power uses interface **P3**, and another connector for logic power uses interface **P2**.



**Figure 5-18. AC Input Voltage Interface (shown here: FLEXI PRO-006)**

Make the following connections:

1. Connect the AC input voltage ground wire to the PE terminal, located on the FLEXI PRO front panel. Use an M4 ring or spade terminal.



**Figure 5-19. Ground Terminals**

2. Connect L1, L2 and L3 (for bus power).
  - If the main voltage is from a single-phase source, connect line and neutral to L1 and L2.
  - If the main voltage is from a three-phase source, connect the phases to L1, L2 and L3.
3. Connect L1C and L2C (for logic power).
  - If the main voltage is from a single-phase source, connect line and neutral to L1C and L2C.
  - If the main voltage is from a three-phase source, connect any two phases to L1C and L2C.



**Make sure the main voltage rating matches the drive specification. Applying incorrect voltage may cause drive failure. Do not apply power until all hardware connections are complete.**



**Prevent inrush surge:**

**Bus Power (L1-L2-L3):** After switching on bus power, wait 1 minute before switching on again, regardless of time in Off state.

**Logic Power (L1C-L2C):** After switching off logic power, wait 1 minute before switching on again.

**Note:** On models FLEXI PRO-1D5 and FLEXI PRO-003, Regen and AC Input Voltage are combined on one connector. Since these models support only single-phase AC, they do not have a L3 terminal for bus power.

**Table 5-41. AC Input Voltage Interface**

<b>FLEXI PRO-1D5 FLEXI PRO-003</b>	<b>Pin</b>	<b>Pin Label</b>	<b>Function</b>
<b>P3</b>	3	<b>L1</b>	AC Phase 1
	4	<b>L2</b>	AC Phase 2
	5	<b>L1C</b>	Logic AC Phase 1
	6	<b>LC2</b>	Logic AC Neutral
<b>FLEXI PRO-4D5 FLEXI PRO-006</b>	<b>Pin</b>	<b>Pin Label</b>	<b>Function</b>
<b>P4</b>	1	<b>L1</b>	AC Phase 1
	2	<b>L2</b>	AC Phase 2
	3	<b>L3</b>	AC Phase 3
	4	<b>L1C</b>	Logic AC Phase 1
	5	<b>LC2</b>	Logic AC Neutral

<b>FLEXI PRO-008 FLEXI PRO-010 FLEXI PRO-013</b>	<b>Pin</b>	<b>Pin Label</b>	<b>Function</b>
<b>P4</b>	1	<b>L1</b>	AC Phase 1
	2	<b>L2</b>	AC Phase 2
	3	<b>L3</b>	AC Phase 3
<b>P5</b>	1	<b>L1C</b>	Logic AC Phase 1
	2	<b>LC2</b>	Logic AC Neutral
<b>FLEXI PRO-020 FLEXI PRO-024</b>	<b>Pin</b>	<b>Pin Label</b>	<b>Function</b>
<b>P3</b>	1	<b>L1</b>	AC Phase 1
	2	<b>L2</b>	AC Phase 2
	3	<b>L3</b>	AC Phase 3
<b>P2</b>	1	<b>L1C</b>	Logic AC Phase 1
	2	<b>LC2</b>	Logic AC Neutral

**Table 5-42. AC Input Voltage Interface Mating Connectors**

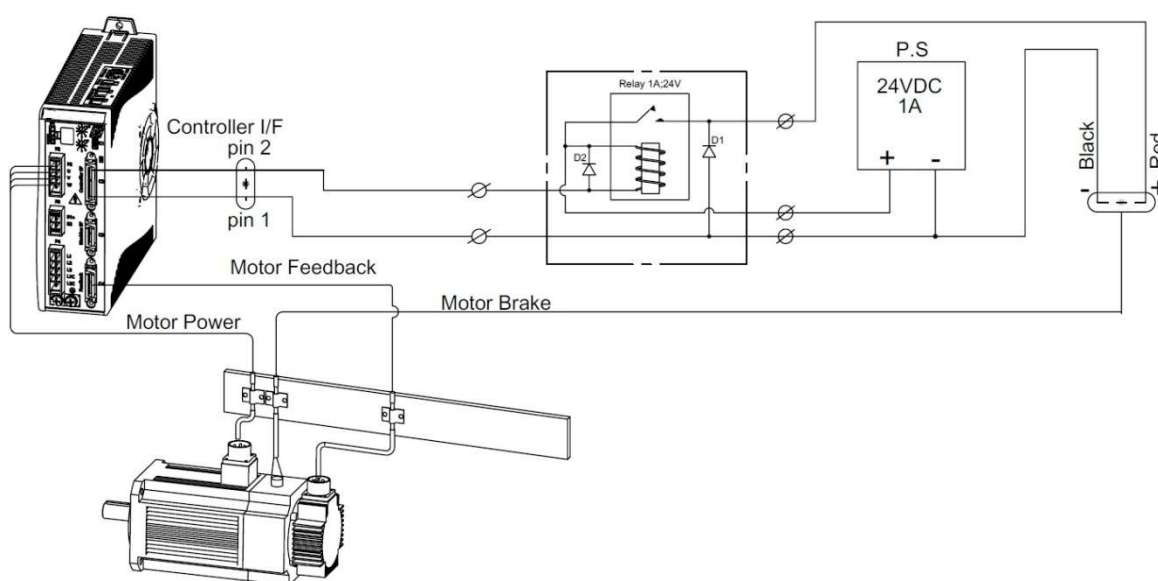
<b>Item</b>	<b>FLEXI PRO-1D5, FLEXI PRO-003</b>
Manufacturer	JST J300
Housing and <b>6-pin</b> crimp (includes Regen)	F32FSS-06V-KX and SF3F-71GF-P2.0
Spring terminal	06JFAT-SBXGF-I (supplied)
Wire gauge	18 AWG
<b>Item</b>	<b>FLEXI PRO-4D5, FLEXI PRO-006</b>
Manufacturer	JST J300
Housing and <b>5-pin</b> crimp	F32FSS-05V-KX and SF3F-71GF-P2.0
Spring terminal	05JFAT-SBXGF-I (supplied)
Wire gauge	16 AWG
<b>Item</b>	<b>FLEXI PRO-008, FLEXI PRO-010, FLEXI PRO-013</b>
Manufacturer	JST J300
Housing and <b>3-pin</b> crimp	J43FSS-03V-KX (supplied) and SJ4F-71GF-M3.0 (supplied)
Spring terminal	Not available
Wire gauge	14 AWG
<b>Item</b>	<b>FLEXI PRO-020, FLEXI PRO-024</b>
Manufacturer	Phoenix Contact
Spring terminal	SPC 5/3-STCL-7,62 (1718494) (supplied)
Wire gauge	12-13 AWG

### 5.7.5 Motor Brake (Optional)

The FLEXI PRO 120/240 VAC models do not have sufficient amperage to activate a motor brake. The FLEXI PRO can be connected to a motor brake via a relay, as shown in the example below. The selection of power supply, relay and diodes depends on the specification of the actual motor brake used in your application.

In this example, the following specifications are assumed:

- Motor brake is 24V and requires less than 1A.
- Motor brake is connected to FLEXI PRO digital output 1.
- Diodes: D1 and D2 PN 1N4002 (Vr 100 V).
- Relay: 24 V < 50mA
- Relay coil: > 500 Ω



**Figure 5-20. Motor Brake Wiring (Example) - FLEXI PRO 120/240 VAC**

Controller I/F Pin	Function	Description
1	24 VDC return	AP/AF Models: Return of the user-supplied 24 VDC
2	Digital output 1	Opto-isolated programmable digital output. Read using OUT1

You can connect the relay to other digital output pins on the FLEXI PRO Machine I/F or Controller I/F connector.

Refer to the controller interface wiring diagram (AP/AF Models) in Figure 4-28 and/or the machine interface wiring diagram (AP/AF Models) in Figure 4-31.



## 5.8 Power Board Connections – 400/480 VAC

On all FLEXI PRO 400/480 VAC models, the power board has the following interfaces:

- STO – P1
- Logic Power 24 VDC – P2
- AC Input and Regeneration – P3
- Brake – P4
- Motor – P5



**Make sure the main voltage rating matches the drive specification. Applying incorrect voltage may cause drive failure. Do not apply power until all hardware connections are complete.**

### 5.8.1 STO

**STO** uses interface **P1** on all FLEXI PRO 400/480 VAC models.

FLEXI PRO-24 and FLEXI PRO-30, 400/480 VAC models, also have a second STO interface, **P3**.

Safe torque off (STO) is a safety function that prevents the drive from delivering power to the motor, which can generate torque.

For complete details, refer to the *FLEXI PRO Functional Safety Reference Guide*.



**Warning:**

**Do not use the STO function until this functionality has been approved.**

The STO input is functional but not yet independently certified for the FLEXI PRO 400/480 VAC models.

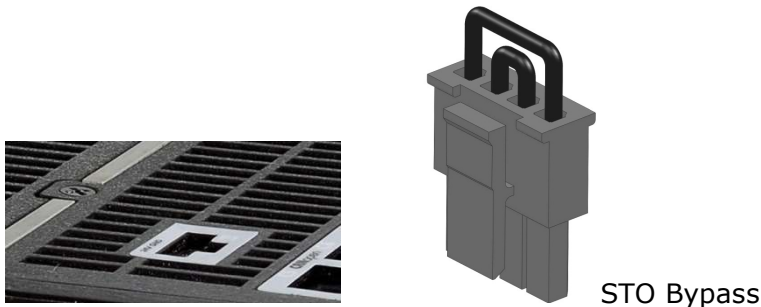


**Warning:**

Drives with a suspended load must have an additional mechanical safety block (such as a motor-holding brake). The drive cannot hold the load when STO is active. Serious injury could result if the load is not properly safeguarded.

STO Enable and STO Return must be connected to enable FLEXI PRO operation. The STO Enable signal voltage must be 24 VDC.

**Note:** If the application does not require STO control, jumper pin 4 to pin 1, and pin 3 to pin 2, to bypass the STO.



**Figure 5-21. STO Interface**

**Table 5-43. STO Interface**

Pin	Pin Label	Function
1	24V	STO Enable
2	GND	24 VDC Return
3		
4		

**Table 5-44. STO Interface Mating Connector**

Item	All Models
Manufacturer	Molex*
Housing and 4-pin crimp	436450400* and 0430300001*
Spring terminal	Not available
Wired STO	Motor Power Company CONr00000004-AS (supplied)
Wire gauge	26–28 AWG

\* Or equivalent.

## 5.8.2 Logic Power 24V Input

**Logic Power 24V** uses interface **P2** on all FLEXI PRO 400/480 VAC models.

This interface is used to connect an external power supply (24V 3.15A max.) that provides the logic voltage to the control board and to the motor brake circuit.



### Prevent inrush surge:

After switching Logic Power Off, wait 1 minute before switching On again.

**Figure 5-22. Logic Power 24V Input Interface****Table 5-45. Logic Power 24V Input Interface**

Pin	Pin Label	Function
1	24V	Logic In
2	GND	24 VDC Return

**Table 5-46. Logic Power 24V Input Interface Mating Connector**

Item	All Models
Manufacturer	Molex
Housing and 2-pin crimp	436450200 (supplied) and 0430300001 (supplied)
Spring terminal	Not available
Wired STO	Motor Power Company CONr00000004-AS (supplied)
Wire gauge	26–28 AWG

### 5.8.3 AC Input and Regeneration Resistor

On the FLEXI PRO 400/480 VAC models, **AC Input** and **Regen Resistor** are combined on one connector, and use the following interfaces:

- **P3** on FLEXI PRO-003/FLEXI PRO-006/FLEXI PRO-012
  - **P5** on FLEXI PRO-024/FLEXI PRO-030
1. Connect the AC input voltage ground wire to the PE terminal, located on the FLEXI PRO front panel. Use an M4 ring or spade terminal.



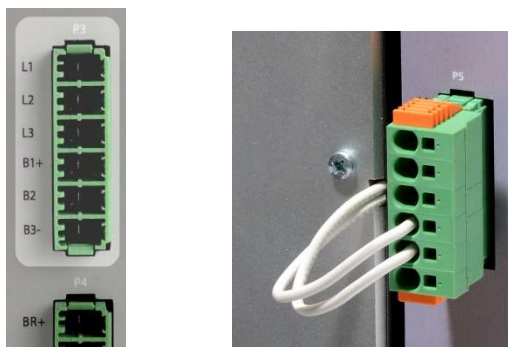
**Figure 5-23. Functional Ground – PE Terminal**

2. Connect L1, L2 and L3 (for bus power).
3. If the application requires a regeneration (regen) resistor, connect the regen resistor between terminals B1+ and B2.



**Prevent inrush surge:**

After switching on bus power, wait 1 minute before switching On again, regardless of time in Off state.



**Figure 5-24. AC Input and Regeneration Resistor Interfaces**

**Table 5-47. AC Input and Regeneration Resistor Interface**

Pin	Pin Label	Function
1	L1	AC Phase 1
2	L2	AC Phase 2
3	L3	AC Phase 3
4	B1+	DC Bus +
5	B2	Regen Bus
6	B3-	DC Bus -

**Table 5-48. AC Input and Regeneration Resistor Interface Mating Connector**

Item	All Models
Manufacturer	Phoenix Contact
Spring terminal	SPC 5/6-STCL-7,62 (1718520) (supplied)
Wire gauge	FLEXI PRO-003/006/012: 12-14 AWG FLEXI PRO-024/030: 10-12 AWG

### Connecting an External Regeneration Resistor

The FLEXI PRO 400/480 VAC has an internal resistor capacity of 300W. For applications in which regeneration power is expected to be greater than 300W, an external regeneration resistor is required.

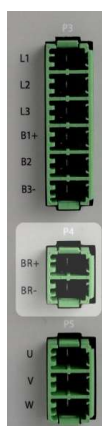
Disconnect the internal regeneration resistor wires from terminals B1+ and B2. Then, connect your own external resistor to B1+ and B2.

Recommended external regeneration resistors are listed in the section *Regeneration Resistors*.

### 5.8.4 Motor Brake

**Brake** uses interface **P4** on all FLEXI PRO 400/480 VAC models.

This is the power output for the electric motor brake system.

**Figure 5-25. Brake Interface**

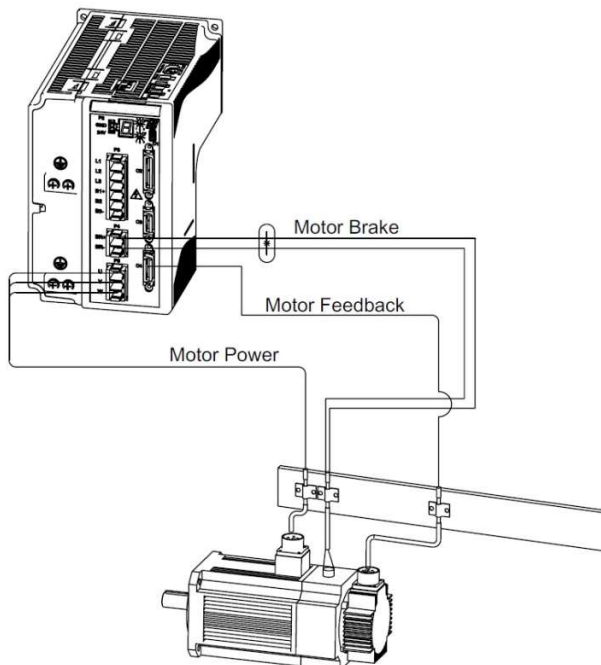
**Table 5-49. Brake Interface**

Pin	Pin Label	Function
1	BR+	Motor Brake +
2	BR-	Motor Brake -

**Table 5-50. Brake Interface Mating Connector**

Item	All Models
Manufacturer	Phoenix Contact
Spring terminal	SPC 5/2-STCL-7,62 (1718481) (supplied)
Wire gauge	14-17 AWG

Motor brake wiring is shown in Figure 5-20.

**Figure 5-26. Motor Brake Wiring - FLEXI PRO 400/480 VAC**

Digital Output 7 is dedicated to brake control in all FLEXI PRO 400/480 VAC models.

To make the brake output functional, use the Flexi SUITE Digital IOs screen to set **Digital Output 7** as **2-Brake Release Signal**.

Alternately, use the Terminal to define the output function:

```
output 7 2
```

### Motor Brake Faults in FLEXI PRO 400/480 VAC

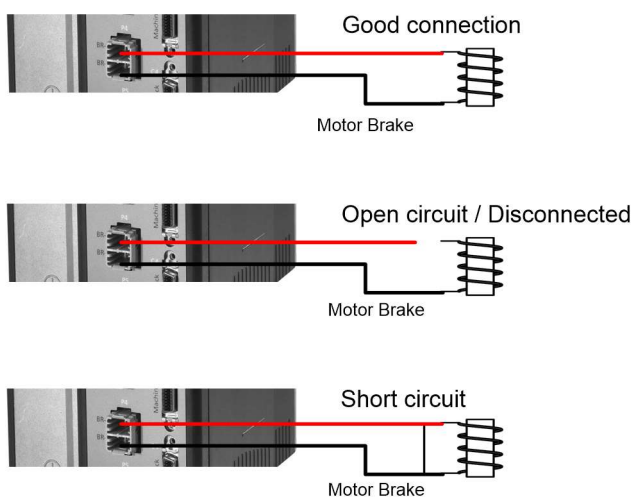
Because of circuitry differences among the FLEXI PRO drives, brake faults are detected differently across the product line.

When the drive detects a motor brake fault, the 7-segment display shows **n45**, and the message **FLT 98 Power Brake Fault** is issued.

The following table and diagram show the conditions which may result in the detection and declaration of a fault.

**Table 5-51. Brake Fault Conditions**

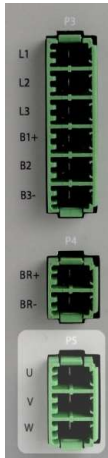
Condition	Model FLEXI PRO-003 FLEXI PRO-006 400/480 VAC	FLEXI PRO-012 FLEXI PRO-024 FLEXI PRO-030 400/480 VAC
FLEXI PRO Disabled and Brake wire disconnected (open)	Fault detected	Fault detected
FLEXI PRO Disabled and Brake wire shorted	No fault detected	No fault detected
FLEXI PRO Enabled and Brake wire disconnected (open)	No fault detected	Fault detected
FLEXI PRO Enabled and Brake wire shorted	Fault detected	Fault detected



**Figure 5-27. Motor Brake Wiring States**

## 5.8.5 Motor

**Motor** uses interface **P5** on all 400/480 VAC models:



**Figure 5-28. Motor Interface**

**Table 5-52. Motor Interface**

Pin	Pin Label	Function
1	U	Motor Phase U
2	V	Motor Phase V
3	W	Motor Phase W

**Table 5-53. Motor Interface Mating Connector**

Item	All Models
Manufacturer	Phoenix Contact
Spring terminal	SPC 5/3-STCL-7,62 (1718494) (supplied)
Wire gauge	FLEXI PRO-003/006/012: 12-14 AWG FLEXI PRO-024/030: 10-12 AWG

## 5.9 Regeneration

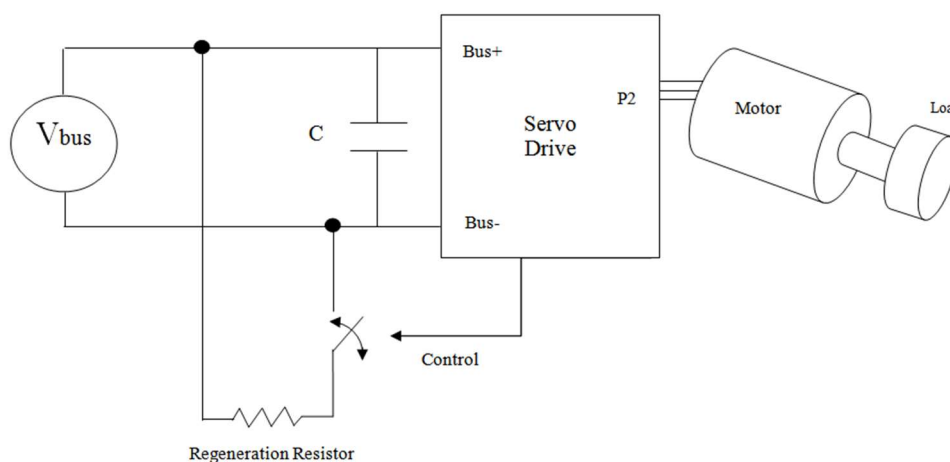
### 5.9.1 Regenerative Energy Overview

When a motor and load decelerate rapidly, kinetic energy of the load drives the motor shaft energy back to the drive; this is called regenerative energy, or regeneration. This energy must be dissipated or absorbed.

Regenerative energy that is not dissipated is added to the electrical energy already stored in the capacitors of the bus module. If the capacitors are capable of storing the energy, the system does not require a regeneration resistor.

In some cases, often due to a high inertial mismatch between the load and motor, excessive energy is added to the capacitors, causing the voltage on the capacitors to reach the over-voltage threshold, which then disables the drive. To prevent over-voltage, and potential damage to the system, the excessive regenerative energy must be dissipated by a regeneration resistor.

To determine whether a system requires a regeneration resistor, and if so, the level of capacity, refer to the section *Regeneration Resistance Calculations* to calculate system properties.



**Figure 5-29. Regeneration Resistor Circuit**

## 5.9.2 Regeneration Resistance Calculations

### FLEXI PRO Bus Specifications

**Table 5-54. Bus Specifications - Single Phase 120/240 L-L VAC**

Drive Model	Capacitance ( $\mu\text{F}$ )	$V_{\text{NOM}}$ (VDC)	$V_{\text{Low}}$ (VDC)	$V_{\text{High}}$ (VDC)	$V_{\text{MAX}}$ (VDC)
FLEXI PRO-1D5	360	170/340	380	400	420
FLEXI PRO-003	660	170/340	380	400	420
FLEXI PRO-4D5	1120	170/340	380	400	420
FLEXI PRO-006	1120	170/340	380	400	420
FLEXI PRO-008	2110	170/340	380	400	420
FLEXI PRO-010	2110	170/340	380	400	420

**Table 5-55. Bus Specifications - Three Phase 120/240 L-L VAC**

Drive Model	Capacitance ( $\mu\text{F}$ )	$V_{\text{NOM}}$ (VDC)	$V_{\text{Low}}$ (VDC)	$V_{\text{High}}$ (VDC)	$V_{\text{MAX}}$ (VDC)
FLEXI PRO-4D5	1120	170/340	380	400	420
FLEXI PRO-006	1120	170/340	380	400	420
FLEXI PRO-008	2110	170/340	380	400	420
FLEXI PRO-010	2110	170/340	380	400	420
FLEXI PRO-013	2110	170/340	380	400	420
FLEXI PRO-020	3280	170/340	380	400	420
FLEXI PRO-024	3280	170/340	380	400	420



**Table 5-56. Bus Specifications - Three Phase 400/480 L-L VAC**

Drive Model	Capacitance (μF)	V <sub>NOM</sub> (VDC)	V <sub>Low</sub> (VDC)	V <sub>High</sub> (VDC)	V <sub>MAX</sub> (VDC)	Internal regen resistor resistance (Ω)
FLEXI PRO-003	410	540/680	770	780	800	33
FLEXI PRO-006	410	540/680	770	780	800	33
FLEXI PRO-012	820	540/680	770	780	800	22
FLEXI PRO-024	3280	540/680	770	780	800	12
FLEXI PRO-030	3280	540/680	770	780	800	12

**Notes:**

- FLEXI PRO 400/480 VAC models have an internal resistor capacity of 300W. For applications in which regeneration power is expected to be greater than 300W, an external regeneration resistor is required. Disconnect the internal regeneration resistor wires from connector P3 (B1+ and B2). Then, connect your own external resistor to B1+ and B2.
- FLEXI PRO 120/240 VAC models do not have an internal regeneration resistor.

**Calculating the Energy Returned for Each Deceleration**

$$E_{\text{dec}} = \frac{1}{2}(J_M + J_L)(\omega_1^2 - \omega_2^2)$$

Where:

- $E_{\text{dec}}$  = Energy returned during deceleration (J or ft·lb)  
 $J_M$  = Rotor inertia (kg·m<sup>2</sup> or lb·ft·sec<sup>2</sup>)  
 $J_L$  = Load inertia (kg·m<sup>2</sup> or lb·ft·sec<sup>2</sup>)  
 $\omega_1$  = Speed at the start of deceleration (rad/s)  
 $\omega_2$  = Speed at the end of deceleration (rad/s)

**Determining the Amount of Energy Dissipated by the Motor**

Due to current flow through the motor winding resistance, some energy is dissipated by the motor:

$$E_{\text{motor}} = 3I_M^2 \cdot (R_M/2) \cdot t_d$$

Where:

- $E_{\text{motor}}$  = Energy dissipated by the motor (J)  
 $R_M$  = Motor resistance (Ω L-L)  
 $I_M$  = Current during deceleration (ARMS/phase)  
 $t_d$  = Time of deceleration (s)

**Determining the Amount of Energy Dissipated by Friction**

$$E_{\text{friction}} = \frac{1}{2}T_f(\omega_1 - \omega_2)t_d$$

Where:

$E_{\text{friction}}$	=	Energy dissipated by friction (J or ft·lb)
$T_f$	=	Friction torque (N·m or lb·ft)
$\omega_1$	=	Speed at the start of deceleration (rad/s)
$\omega_2$	=	Speed at the end of deceleration (rad/s)
$t_d$	=	Time of deceleration (s)

### Determining the Energy to be Dissipated by the Amplifier

$$E_M = E_{\text{dec}} - E_{\text{motor}} - E_{\text{friction}}$$

Where:

$$E_M = \text{Total energy to be dissipated by the amplifier (J or ft·lb)}$$

If this energy is less than that which the bus module can store, no regeneration resistor is needed.

$E_M$  should be expressed in joule. The conversion ratio from ft·lb to joule is:

$$1 \text{ ft·lb} = 1.356 \text{ J}$$

### Determining the Energy the Bus Can Absorb

$$E_{\text{BUS}} = \frac{1}{2} C (V_M^2 - (V_{\text{NOM}})^2)$$

$$E_{\text{BUS}} = \text{Energy the bus module can absorb (J)}$$

$$C = \text{Bus module capacitance (F) ; see section } \textit{Bus Specifications}$$

$$V_M = \text{Maximum bus voltage (V); see section } \textit{Bus Specifications}$$

$$V_{\text{NOM}} = \text{Nominal bus voltage} = \sqrt{2} V_{\text{mains}} \text{ (V)}$$

Determine if a regeneration resistor is required

If  $E_{\text{BUS}} > E_M$     Regeneration resistor is not required.

If  $E_{\text{BUS}} < E_M$     Regeneration resistor is required.

### Determining Resistor Value

The procedure for calculating regeneration requirements is twofold. Both the regeneration resistance value and the resistor wattage must be determined.

### Determining the Resistance Value

$$R_{\text{Max}} = \frac{V_M^2}{V_B I_M \sqrt{3}}$$

Where:

$$V_B = \text{Motor back EMF less motor losses.}$$

$$V_B = K_B N - \sqrt{3} I_M (R_M / 2)$$

$$V_M = \text{Maximum bus voltage (V); see section } \textit{Bus Specifications}$$

$$K_B = \text{Back EMF constant (V L-L / rpm)}$$

$$N = \text{motor speed prior to deceleration (rpm)}$$

$I_M$  = Current during deceleration (ARMS/phase)

$R_M$  = Motor resistance ( $\Omega$  L-L)

### Determining the Average Dissipated Power

$$P_{AV} = \frac{E_M - \frac{1}{2}C(V_{High}^2 - V_{Low}^2)}{t_{cycle}}$$

Where:

$E_M$  = Total energy needs to be dissipated by the amplifier (J)

$C$  = Bus module capacitance (F); see section *Bus Specifications*

$V_{High}$  = Hysteresis point: Regen circuit turn on(V) ; see section *Bus Specifications*

$V_{Low}$  = Hysteresis point: Regen circuit turn off (V) ; see section *Bus Specifications*

$t_{cycle}$  = Time between decelerations + time of deceleration (s)

### Determining the Peak Resistor Power

$$P_{PK} = \frac{V_M^2}{R_{Regen}}$$

$R_{Regen}$  = Regeneration resistor resistance ( $\Omega$  L-L)

$V_M$  = Maximum bus voltage (V); see section *Bus Specifications*

## Regeneration Calculation Example – US Standards Units

### Motor and Drive Specifications

FLEXI PRO-006 drive with 240 VAC single phase input

$J_{motor} = 0.000484 \text{ lb}\cdot\text{ft}\cdot\text{sec}^2$

$R_M = 1.32 \Omega$

$I_{peak} = 18 \text{ A}$

$T_M = 19.8 \text{ lb}\cdot\text{ft}$

$C = 0.001120 \text{ F}$

$V_M = 420 \text{ V}$

$K_B = 81.2 \text{ V/krpm} = 0.0812 \text{ V/rpm}$

$k_t = 1.188 \text{ lb}\cdot\text{ft/A}$

### System Specifications

$T_f = 1.5 \text{ lb}\cdot\text{ft}$

$J_{Load} = 0.0015 \text{ lb}\cdot\text{ft}\cdot\text{sec}^2$

$V_{Max} = 2,500 \text{ rpm} \Rightarrow \omega_M = 261 \text{ rad/s}$

$V_{NOM} = 240 \text{ Vrms} = 340 \text{ VDC}$

Time between decelerations = 5 s

### Time of Deceleration Calculation

$$t_d = \frac{(J_{\text{Motor}} + J_{\text{Load}}) \cdot (\omega_M)}{(T_M + T_f)} = (0.000484 + 0.001) \cdot (261) / (19.8 + 1.5) = 0.0181 \text{ s}$$

### Current During Deceleration Calculation

$$I_M = \frac{(J_{\text{Motor}} + J_{\text{Load}})}{k_t} \cdot \frac{\omega_1 - \omega_2}{t_d} = \frac{0.001 + 0.000484}{1.188} \cdot \frac{261}{0.0181} = 18 \text{ A}$$

### Energy Calculation

$$E_{\text{dec}} = \frac{1}{2} (J_M + J_L) (\omega_1^2 - \omega_2^2) = \frac{1}{2} (0.0015 + 0.000484) (261^2 - 0) = 67.57 \text{ ft} \cdot \text{lb} = 91.63 \text{ J}$$

$$E_{\text{motor}} = 3I_M^2 \cdot (R_M/2) \cdot t_d = 3 \cdot 18^2 \cdot \left(\frac{1.32}{2}\right) \cdot 0.0181 = 11.61 \text{ J}$$

$$E_{\text{friction}} = \frac{1}{2} T_f (\omega_1 - \omega_2) t_d = \frac{1}{2} \cdot 1.5 (261 - 0) \cdot 0.0181 = 3.54 \text{ ft} \cdot \text{lb} = 4.8 \text{ J}$$

$$E_M = E_{\text{dec}} - E_{\text{motor}} - E_{\text{friction}} = 91.633 - 11.611 - 4.8 = 75.22 \text{ J}$$

$$E_{\text{BUS}} = \frac{1}{2} C (V_M^2 - V_{\text{NOM}}^2) = \frac{1}{2} \cdot 0.001120 (420^2 - 340^2) = 34.05 \text{ J}$$

Since  $E_M > E_{\text{BUS}}$ , a regeneration resistor is required.

### Resistor Specification Calculation

$$V_B = K_B N \cdot \sqrt{3} I_M \left(\frac{R_M}{2}\right) = 0.0812 \cdot 2500 \cdot \sqrt{3} \cdot 18 \cdot \left(\frac{1.32}{2}\right) = 182.423 \text{ V}$$

$$R_{\text{MAX}} = \frac{V_M^2}{V_B I_M \sqrt{3}} = \frac{420^2}{182.423 \cdot 18 \cdot \sqrt{3}} = 31.02 \text{ } \Omega$$

$$P_{\text{AV}} = \frac{E_M \cdot \frac{1}{2} C (V_{\text{High}}^2 - V_{\text{Low}}^2)}{t_{\text{cycle}}} = \frac{75.22 \cdot \frac{1}{2} \cdot 0.001120 \cdot (400^2 - 380^2)}{5.0181} = 13.25 \text{ W}$$

$$P_{\text{PK}} = \frac{V_M^2}{R_{\text{Regen}}} = \frac{420^2}{1.32} = 5686.65 \text{ W}$$

### Regeneration Calculation Example – MKS Units

#### Motor and Drive Specifications

FLEXI PRO-006 drive with 240 VAC single phase input

$$J_{\text{motor}} = 0.0006562 \text{ kg} \cdot \text{m}^2$$

$$R_M = 1.32 \text{ } \Omega$$

$$I_{\text{peak}} = 18 \text{ A}$$

$$T_M = 16.08 \text{ N} \cdot \text{m}$$

$$C = 0.001120 \text{ F}$$

$$V_M = 420 \text{ V}$$

$$K_B = 81.2 \text{ V/krpm} = 0.0812 \text{ V/rpm}$$

$$k_t = 1.042 \text{ N} \cdot \text{m/A}$$

#### System Specifications

$$T_f = 2.5 \text{ N} \cdot \text{m}$$

$$J_{\text{Load}} = 0.0015 \text{ kg} \cdot \text{m}^2$$

$$V_{\text{Max}} = 2,500 \text{ RPM} \Rightarrow \omega_M = 261 \text{ rad/s}$$

$$V_{\text{NOM}} = 220 \text{ Vrms} = 340 \text{ VDC}$$

Time between deceleration = 5 s

### Time of Deceleration Calculation

$$t_d = \frac{(J_{\text{Motor}} + J_{\text{Load}}) \cdot (\omega_1)}{(T_M + T_f)} = \frac{(0.0006562 + 0.0015)(261)}{(16.08 + 2.5)} = 0.03 \text{ s}$$

### Current During Deceleration Calculation

$$I_M = \frac{(J_{\text{Motor}} + J_{\text{Load}})}{k_t} \cdot \frac{\omega_1 - \omega_2}{t_d} = \frac{0.0006562 + 0.0015}{1.042} \cdot \frac{261}{0.03} = 18 \text{ A}$$

### Energy Calculation

$$E_{\text{dec}} = \frac{1}{2} (J_M + J_L) (\omega_1^2 - \omega_2^2) = \frac{1}{2} (0.0006562 + 0.0015) (261^2 - 0) = 73.44 \text{ J}$$

$$E_{\text{motor}} = 3I_M^2 \cdot (R_M/2) \cdot t_d = 3 \cdot 18^2 \cdot \left(\frac{1.32}{2}\right) \cdot 0.03 = 19.24 \text{ J}$$

$$E_{\text{friction}} = \frac{1}{2} T_f (\omega_1 - \omega_2) t_d = \frac{1}{2} \cdot 2.5 \cdot (261 - 0) \cdot 0.03 = 9.78 \text{ J}$$

$$E_M = E_{\text{dec}} - E_{\text{motor}} - E_{\text{friction}} = 73.44 - 19.24 - 9.78 = 44.42 \text{ J}$$

$$E_{\text{BUS}} = \frac{1}{2} C (V_M^2 - V_{\text{NOM}}^2) = \frac{1}{2} \cdot 0.001120 (420^2 - 340^2) = 34.05 \text{ J}$$

Since  $E_M > E_{\text{BUS}}$ , a regeneration resistor is required.

### Resistor Specification Calculation

$$V_B = K_B N - \sqrt{3} I_M \left(\frac{R_M}{2}\right) = 0.0812 \cdot 2500 - \sqrt{3} \cdot 18 \cdot \left(\frac{1.32}{2}\right) = 182.423 \text{ V}$$

$$R_{\text{MAX}} = \frac{V_M^2}{V_B I_M \sqrt{3}} = \frac{420^2}{182.423 \cdot 18 \cdot \sqrt{3}} = 31.02 \text{ } \Omega$$

$$P_{\text{AV}} = \frac{E_M - \frac{1}{2} C (V_{\text{High}}^2 - V_{\text{Low}}^2)}{t_{\text{cycle}}} = \frac{44.42 - \frac{1}{2} \cdot 0.001120 \cdot (400^2 - 380^2)}{5.03} = 7.1 \text{ W}$$

$$P_{\text{PK}} = \frac{V_M^2}{R_{\text{Regen}}} = \frac{420^2}{1.32} = 5686.65 \text{ W}$$

## 5.9.3 Regeneration Resistor Protection

### Regeneration Resistor Overload Protection Overview

The regeneration resistor circuitry itself requires overload protection to ensure the resistor functions reliably.

The FLEXI PRO has configurable parameters for the protection of the regeneration resistor. To apply this protection, set the parameters as described in the following sections.



#### **Use the regeneration resistor protection with caution.**

If the motor increases bus voltage, resulting in activation of the protection mechanism, an over-voltage condition may result.

## Regeneration Resistor Parameters

The regeneration resistor capacity is defined by three parameters.

To activate the regeneration resistor protection function in the FLEXI PRO, parameter REGENRES and/or parameter REGENPOW must be set to a value other than **-1**, which is the default value.

VarCom	Description
REGENRES	Resistance of the regeneration resistor, in ohms.
REGENPOW	Power of the regeneration resistor, in watts.
REGENMAXONTIME	The maximum time for which the regeneration resistor may be continually activated (on), in milliseconds.

**Note:** If the system does not have a regeneration resistor, set REGENRES = -1 and REGENPOW = -1

If the system has a regeneration resistor, a value of -1 for either REGENRES or REGENPOW deactivates the regeneration resistor overload protection algorithm.

## Regeneration Resistor Protection Algorithm

A regeneration resistor has a typical thermal constant of 5 seconds. This means the resistor is considered not loaded (its initial state) if it is not switched on (activated) during a given 5-second interval. Therefore, the FLEXI PRO algorithm takes into account the On time and Off time of the regeneration resistor during the previous 5 seconds.

The maximum On time for the regeneration resistor during the 5-second interval is defined by REGENMAXONTIME. For example, REGENMAXONTIME = 0.5 [s] corresponds to a maximum duty-cycle:

$$D = \frac{0.5 [s]}{5 [s]} = 10 \%$$

This value is used if unsuitable values have been entered for REGENRES and/or REGENPOW.

The energy consumed by the regeneration resistor can be estimated by the following equation, assuming that the actual bus voltage will not significantly exceed the trip voltage ( $V_{trip}$ ).

$$E_{regen} = \frac{V_{trip}^2}{R} \cdot t_{on}$$

where:  $t_{on}$  = On time during the last 5-second interval

The power consumed during the last 5-second interval can then be averaged by applying the following equation:

$$P_{regenaverage} = \frac{E_{regen}}{5[s]} = \frac{V_{trip}^2}{R} \cdot \frac{t_{on}}{5[s]}$$

The regeneration resistor protection algorithm ensures that the maximum power of the resistor is never exceeded, meaning the following statement must always be true:

$$\text{REGENPOW} > \frac{P_{regenaverage}}{5[s]}$$

### Example: Determining the Maximum On Time

The regeneration resistor has the following properties:

$$\text{REGENRES} = 100 [\Omega]$$

$$\text{REGENPOW} = 60 [\text{W}]$$

$$\text{FLEXI PRO } V_{\text{trip}} = 400 [\text{V}]$$

That is, VMAX (Regen Circuit Turn On) (VDC), as defined in *Mechanical and Electrical Specifications*.

The FLEXI PRO calculates the Power every 1 ms:

$$P_{\text{regen}_{1\text{ms}}} = \frac{400[\text{V}]^2}{100[\Omega]} \cdot \frac{1}{5000[\text{ms}]} = 0.32 [\text{W}/\text{ms}]$$

The maximum On time for this specific regeneration resistor is calculated:

$$t_{\text{on}} = \frac{\text{REGENPOW}}{P_{\text{regen}_{1\text{ms}}}} = \frac{60[\text{W}]}{0.32 [\text{W}/\text{ms}]} = 187.5 [\text{ms}]$$

187.5 ms is less than the maximum On time (ton\_max) of 0.5 second.

In this example, the FLEXI PRO regeneration resistor overload protection algorithm ensures that the regeneration resistor will not be continuously active for more than 187.5 ms during a 5-second interval.

To double-check the calculation and the regeneration power:

$$P_{\text{regen}_{187.5\text{ms}}} = \frac{E_{\text{regen}_{187.5\text{ms}}}}{5[\text{s}]} = \frac{\frac{400[\text{V}]^2}{100[\Omega]} \cdot 0.1875}{5[\text{s}]} = 60[\text{W}]$$

## 5.10 Firmware Update

### 5.10.1 Firmware Update Preparation

**Important:** Before updating the firmware, be sure to do the following:

- Refer to the Release Notes and any other documentation supplied with the new firmware.
- Since parameter settings may be lost during the update, backup drive parameters from each drive in the system, and keep these files secure. After the update is completed, the parameters can be reloaded/restored.

To backup parameters, go the Flexi SUITE **Backup & Restore** screen, and click the **Backup** button.

### 5.10.2 Firmware Update Options

The **Download Firmware** button in the Flexi SUITE **Drive Info** screen opens the Firmware Download dialog box.

When expanded by the **Advanced** button, the dialog contains the following options:

<b>Firmware Path</b>	<p>The path and name of the file containing the firmware update.</p> <p>The file name indicates the firmware version; for example: 1_41_4*.sfw represents firmware version 1.41.4.</p> <p>The default path is \My Documents\Flexi SUITE.</p>
<b>Ember Mode</b>	<p>Ember is the process used for burning new firmware on the drive's flash memory.</p> <ul style="list-style-type: none"> <li>■ <b>Software:</b> Normally use the default <b>Software</b> option.</li> <li>■ <b>Hardware:</b> If the firmware loading process has been interrupted and you are unable to establish communication with the drive, use this option.</li> </ul>
<b>Com Port</b>	<p>The COM port of the host computer to which the drive is connected. Make sure this COM port is not being used by any other application.</p>
<b>Baud Rate</b>	<p>The rate must be set to 115200.</p>
<b>Address</b>	<ul style="list-style-type: none"> <li>■ When only one drive is connected to the host computer, a drive address is not needed. The software attempts to communicate with the drive that was communicating with the host before the Firmware Download process was activated. Thus, if the drive responds to serial communication, the firmware download process will proceed.</li> <li>■ When multiple drives are connected to the host in a daisy-chain, a drive address must be specified. When a drive address is specified, the software starts by sending the command \\ which stops all drives connected to the selected serial port from responding to serial communication. It then issues the command \nn which instructs only the drive with address nn to respond. Then it begins the firmware download.</li> </ul>
<b>Disable Optimization</b>	<p>The firmware update procedure uses an optimization method to improve performance. In rare instances this optimization may cause the procedure to fail. In such an instance, disable the optimization and restart the firmware update.</p>
<b>Restore Parameters</b>	<p>When selected, the firmware update procedure stores all user parameters to memory before downloading the firmware and restores the parameters after the update. This option can be disabled.</p> <p>This option is not available if host and drive are not communicating.</p> <p><b>Note:</b> Regardless of this option setting, it is strongly recommended that you use the <b>Backup</b> option in the <b>Backup &amp; Restore</b> screen to preserve the existing drive parameters before updating the firmware.</p>
<b>Close When Done</b>	<p>When selected, the Firmware Download dialog box closes automatically once the procedure is completed.</p>



### 5.10.3 Firmware Update over Serial Connection

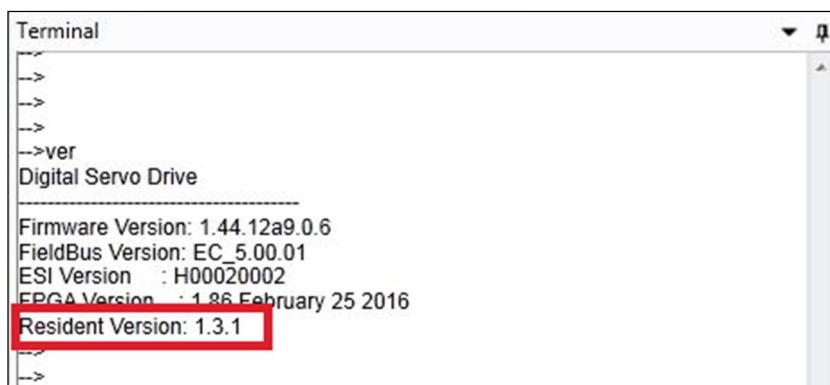
#### Procedure – Updating Drive Firmware over Serial Connection

1. Download the drive's firmware file (\*.sfw) from the product web page to a host computer.
2. From the Flexi SUITE **Drive Info** screen, click **Download Firmware**.  
The **Firmware Download** dialog box opens, and allows you to send the firmware file to the drive over a serial communication link.
3. Browse to and select the firmware file.
4. Press **Start** to download the firmware file to the drive.  
During the firmware update process, the 7-segment LED display shows a steadily lit **E**.  
When the process is complete, the new firmware will start running.
5. Download the drive parameter file to the drive.
6. Execute SAVE to save the parameters in the drive's non-volatile memory.
7. Cycle power, and run the machine.  
If machine behavior has changed, contact Technical Support.
8. Retrieve the parameter file from the drive, and save the file for future reference and backup.
9. Repeat the firmware update procedure for each drive in the machine.

### 5.10.4 Firmware Update over EtherCAT

Firmware updates can be performed using File over EtherCAT (FoE) download protocol. The FLEXI PRO runs in a bootloader state to allow firmware download to the host controller via the EtherCAT network. Standardized firmware download to devices is therefore possible, even without the support of TCP/IP.

**Note:** Drive Resident (Bootloader) must be version 1.3.1 or higher.  
The version can be checked in the Flexi SUITE Terminal screen, by means of the command VER.



```

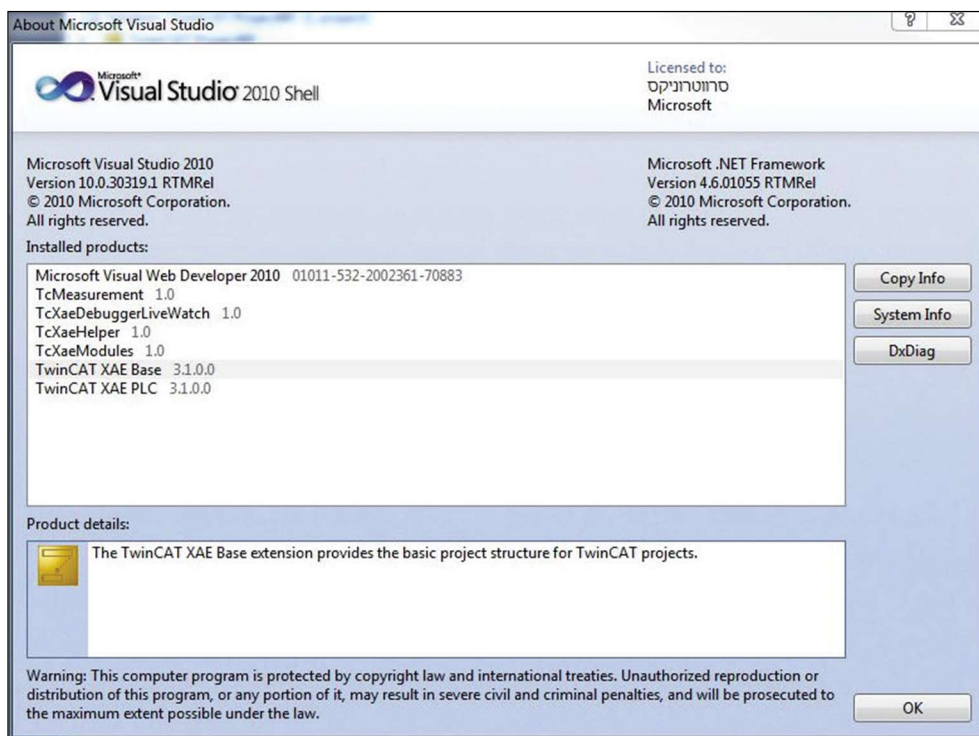
Terminal
-->
-->
-->
-->ver
Digital Servo Drive
-----
Firmware Version: 1.44.12a9.0.6
FieldBus Version: EC_5.00.01
ESI Version : H00020002
FPGA Version : 1.86 February 25 2016
Resident Version: 1.3.1
-->

```

Figure 5-30.

#### Procedure – Updating Drive Firmware over EtherCAT

1. Install TwinCAT 3.0 on the host PC.  
Follow the instructions provided by Beckhoff.

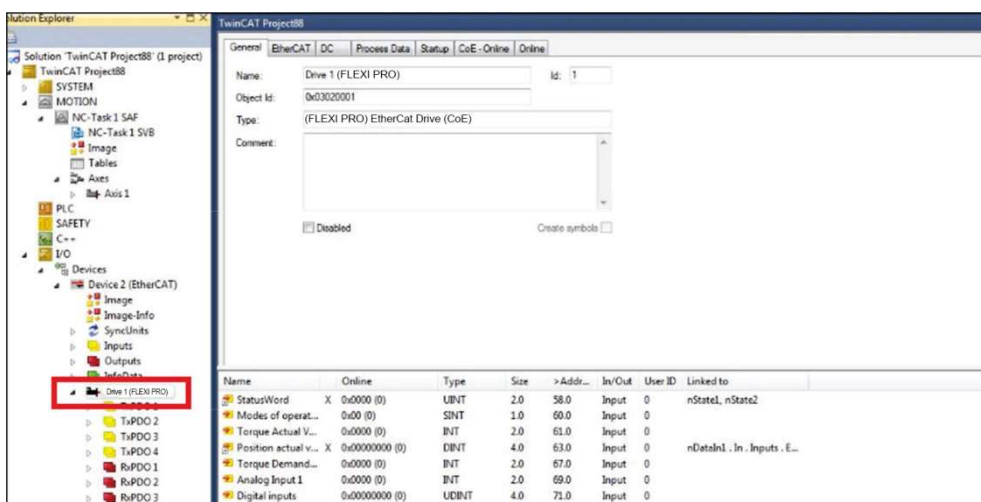


**Figure 5-31.**

2. In TwinCAT connect to FLEXI PRO drive.

For instructions, refer to the EtherCAT and CANopen Reference Manual for FLEXI PRO Servo Drive (FLEXI PRO \_EtherCAT\_CANopen\_fw1.41.2\_Rev.6.3.pdf)

3. In the TwinCAT navigation menu, select I/O > Devices ... FLEXI PRO drive.



**Figure 5-32.**

4. Go to the **Online** tab.
- Click **Bootstrap**.
- Wait until Current States becomes **BOOT**.

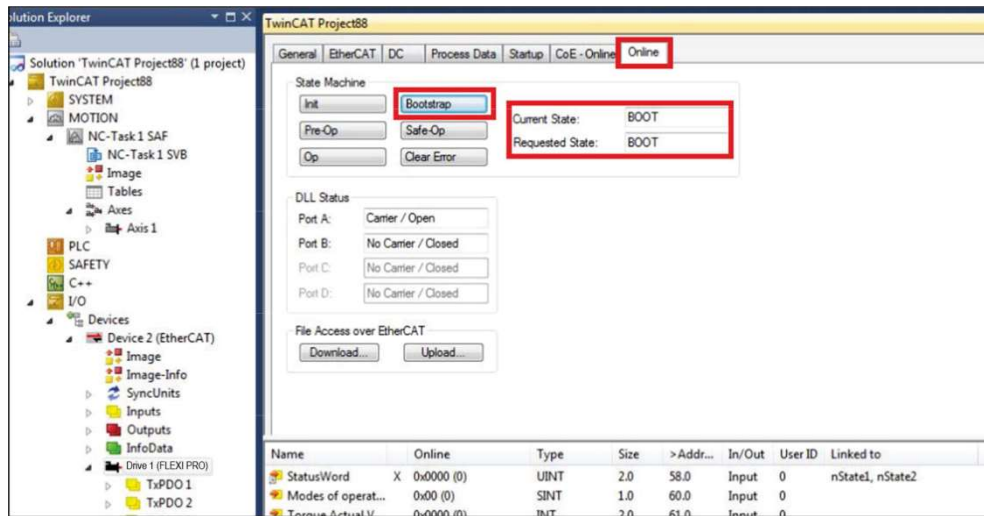


Figure 5-33.

5. Click **Download**.
6. The File Manager dialog box opens.
- Browse to and select the FLEXI PRO firmware file (with \*.i00 extension).
- Click **Open**.

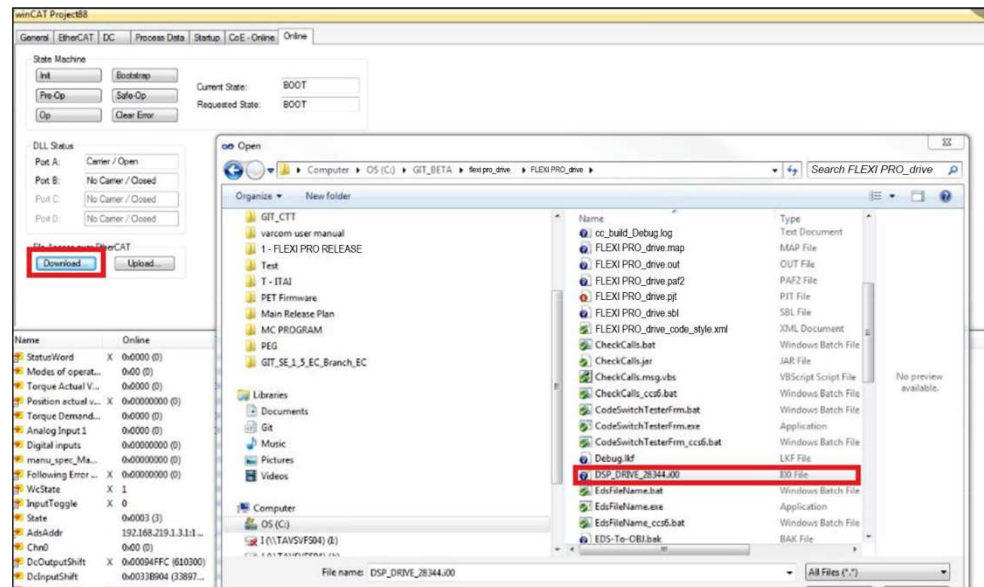


Figure 5-34.

7. The Edit FoE Name dialog box opens.

Do not change anything in this dialog box. Simply click **OK**.

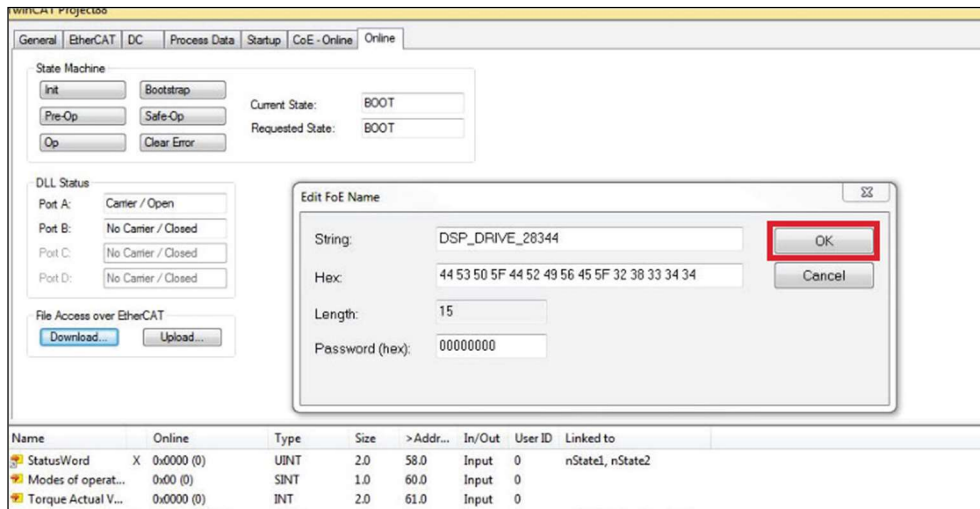


Figure 5-35.

8. The firmware update process begins.

**E** is displayed on the FLEXI PRO 7-segment display panel.



In the TwinCAT status bar at the bottom of the screen, **Downloading** is displayed at the left, and a progress bar is displayed at the right.

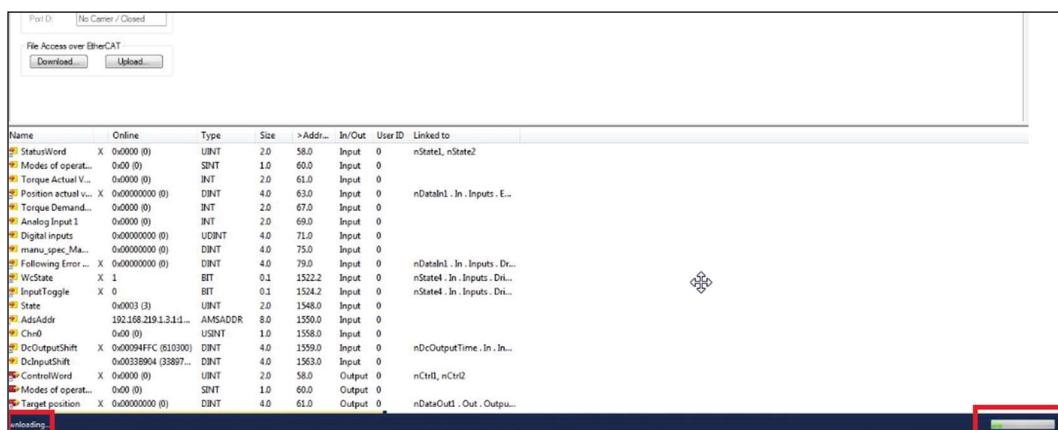


Figure 5-36.

- When the firmware update is completed, the Current State switches from BOOT to **PREOP**.

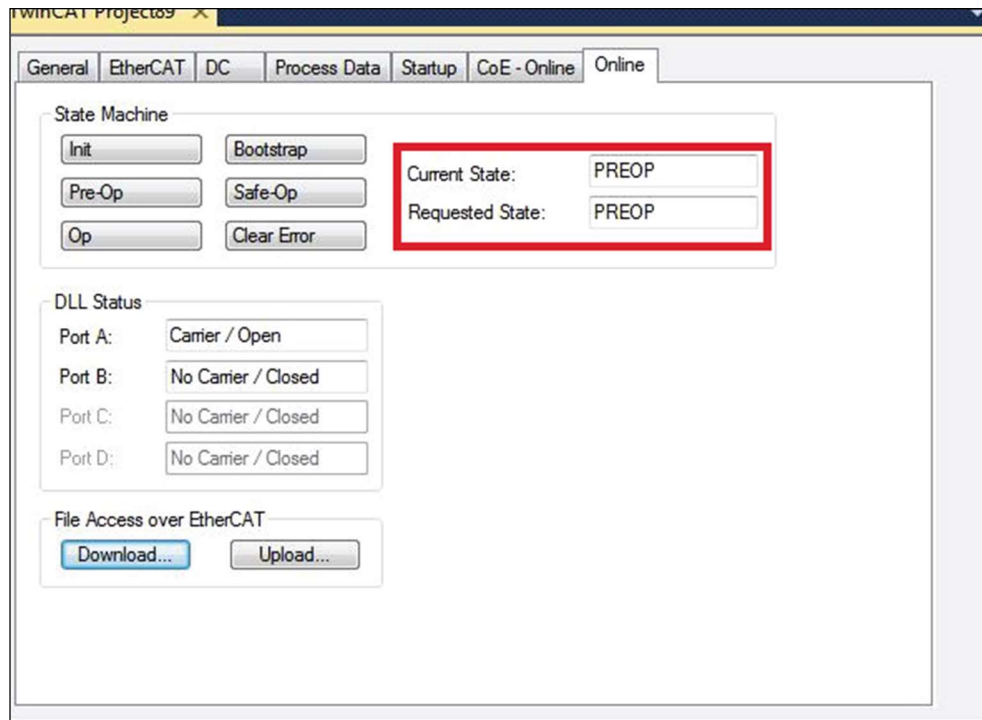


Figure 5-37.

### 5.10.5 Resuming Operation After Firmware Update

#### Procedure – Resuming Operation After Firmware Update

- Go to the Flexi SUITE **Drive Info** screen in Flexi SUITE, and check the drive firmware version to verify that the new firmware has been loaded.
- Open the **Backup & Restore** screen, and click the **Restore** button to reload the previously backed up parameters the drive
- Check the version release note, and set any parameters that may have been added to the new version.
- Save the parameters to the non-volatile parameter memory: either execute the serial command **SAVE** command, or click the **Save** button on the Flexi SUITE toolbar.
- Cycle power, and run the machine. If machine behavior has changed, contact Technical Support.

### 5.10.6 Ember Mode

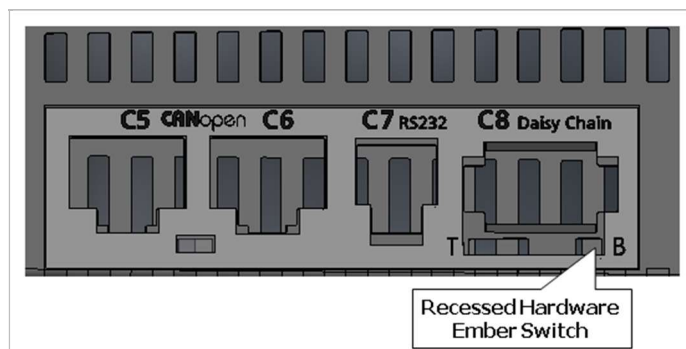
Ember is the process used for burning new firmware on the drive's flash memory. The drive must be in the Ember mode for the firmware to be loaded. The drive has two Ember modes, Software and Hardware.

Normally, you can and should communicate with the drive in Software Ember mode for loading new firmware.

However, if the firmware loading process has been interrupted and you are unable to establish communication with the drive, you need to use the Ember Hardware mode.

To activate the Hardware Ember mode, use a small screwdriver or similar tool to press the Hardware Ember switch. This switch is located on the top of the drive next to the daisy chain connector (C8).

Pressing the switch sets the drive to serial communication Boot-Up Mode. All segments on the front panel 7-segment LED display light up (appears as "8."). If the drive has a fan, the fan rotates at maximum speed. The fan speed will revert to normal after the firmware has been downloaded successfully and the drive has restarted.



**Figure 5-38. Location of Hardware Ember Switch**

## 5.11 Power Up

1. After completing the hardware connections, turn on power to the drive.

**Note:** If logic and bus AC supplies are separate, it is recommended that logic AC be turned on before bus AC.

2. Look at the 7-segment display on the FLEXI PRO front panel.

Upon initial power up, the status display shows a flashing **e**, indicating a Parameter Memory Checksum Failure.

This fault will be cleared once the drive is configured and the parameters are saved in the drive's non-volatile memory.

## 6 Application Setup

### 6.1 Parameters

#### 6.1.1 Configuration Parameters

**VarCom** is a proprietary set of commands and variables, or parameters, used to configure drive functionality when the host and drive are communicating over a serial connection.

VarCom parameters can be accessed and manipulated through Flexi SUITE software, in either graphical interface screens, or a command-line terminal screen.



- While setting parameters, pay close attention to any warning or error messages that appear in Flexi SUITE, and any flashing codes on the drive itself.
- Disable the drive before manipulating motor and feedback parameters.
- Many parameters can be modified while the drive is enabled. Exercise caution, however, as motor behavior may change.
- If a parameter cannot be modified while the drive is enabled, a prompt to disable the drive will be displayed.

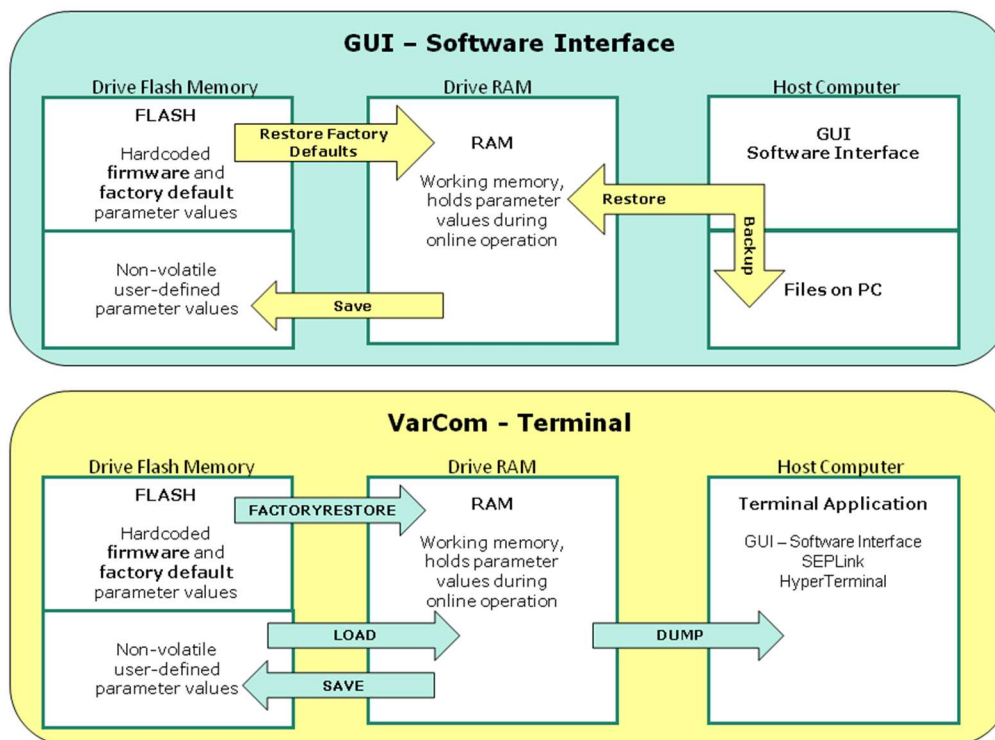
#### 6.1.2 Managing Parameters - Drive Memory

The FLEXI PRO drive has two types of memory for storing the drive's parameters:

- **Flash:** Non-volatile memory. It holds the drive's default parameter values (contained within the drive's firmware), as well as the saved set of parameters.
- **RAM:** Volatile memory. The drive's working memory. Parameter values are maintained in RAM while you configure and test the drive and adjust parameters. If power to the drive is disconnected, any unsaved changes in the parameters will be lost.

During power up, the FLEXI PRO loads parameter values from the non-volatile memory to RAM, and a checksum of these parameter values is calculated. If the checksum is invalid, default parameter values (which are hard-coded in the drive's firmware) are loaded into RAM and a Parameter Memory Checksum Failure fault is set.

The following diagram illustrates the relationships among the different types of memory and commands used for managing the drive parameters.



**Figure 6-1. Memory and Commands for Managing Parameters**

In Flexi SUITE, drive parameters can be saved to non-volatile memory at any time by clicking the **Save** button on the toolbar.

## 6.2 Configuration Sequence

**Note:** It is recommended that you configure and tune the drive using serial communication whenever possible, even if the drive is connected to a CAN network.

In general, drives are shipped from the factory with motor parameters set to zero and application parameters set to their default values.

The following diagram shows the three stages of configuration and tuning.

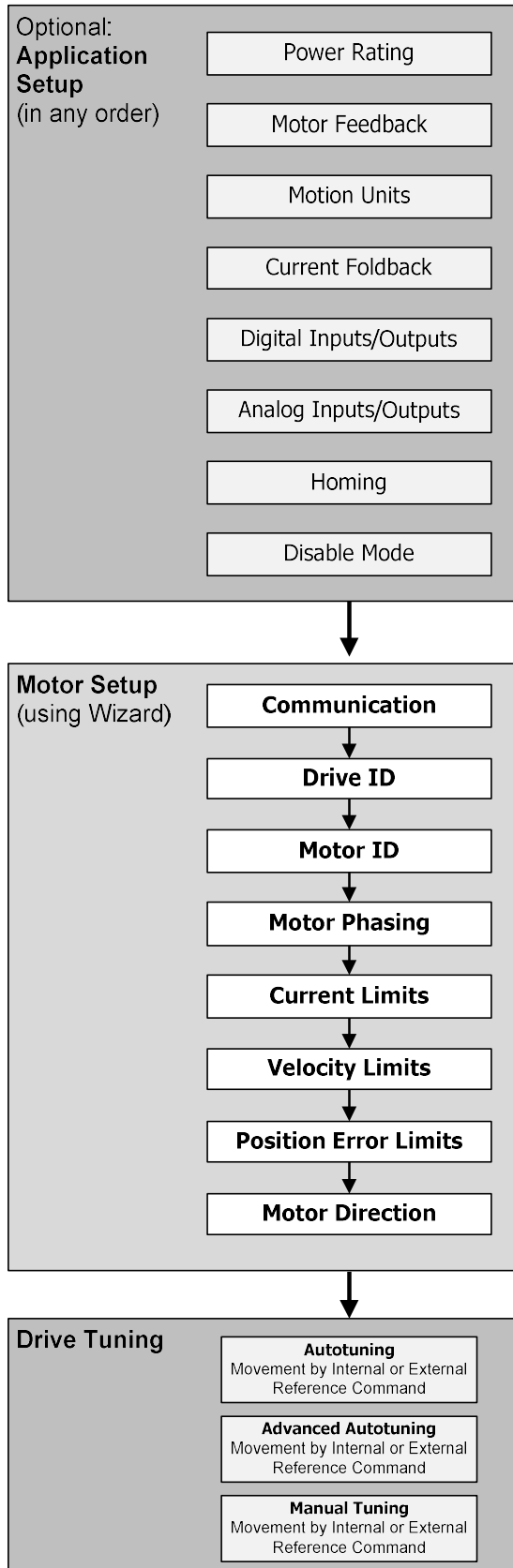
- **Application Setup.** These parameters **can be configured in any order**. Default settings are sufficient in many instances.

When the motor is selected from the Flexi SUITE Motor Library, power rating, motor feedback and current foldback parameters are pre-set and written to the drive. These parameters are manufacturer-defined and should not be manipulated by the user; if you want to make any changes to these parameters, contact Technical Support.

Other application-specific parameters – motion units, digital and analog I/Os, homing method and disabling method – are user definable.

- **Motor Setup.** These parameters are usually configured by a software wizard. Motor Setup parameters and procedures are detailed in [Motor Setup](#).
- **Drive Tuning.** The tuning procedure can be performed by a software wizard with little input from the user. Manual tuning is also possible. Drive tuning parameters and procedures are detailed in [Tuning](#).





**Figure 6-2. Configuration Sequence**

## 6.3 Communication

Commissioning the drive through Flexi SUITE requires a serial RS232 or USB connection. Once the drive is configured, you can then connect it to a PLC or controller over an EtherCAT, CANopen or other fieldbus network.

**Note:** For communication through serial RS232/USB connections and P&D/analog interfaces, the drive must be set to COMMODE 0.

For communication over Ethernet or CAN networks, the drive must be set to COMMODE 1. While COMMODE 1 is in effect, the drive cannot be enabled and the motor cannot be moved through Flexi SUITE. COMMODE 1 is the drive's factory default setting is fieldbus is COMMODE 1.

The Flexi SUITE **Communication** screen allows you to establish communication between the host computer and the drive over a serial connection.

Communication between the host computer and the drive is configured in **Step 0** of the Motor Setup wizard. If Flexi SUITE is already communicating with the drive, the wizard begins at Step 1.

The following parameters are used to configure and monitor communication:

VarCom	Description
COMMODE 0	Serial RS232/USB communication enabled. EtherCAT/CANopen communication disabled. Reference commands accepted via serial/pulse/analog interfaces only.
COMMODE 1	Applicable only for FLEXI PRO <b>AF</b> , <b>EC</b> and <b>EB</b> models. EtherCAT/CANopen communication is enabled. Serial RS232/USB communication can be used as a utility for monitoring and changing parameters with limited functionality. Reference commands cannot be received via serial/pulse/analog interfaces.
BAUDRATE	Sets the serial communication bit rate between the drive and the host computer.
CANBITRATE	Sets the CAN bus communication bit rate between the drive and the host computer.

### 6.3.1 Serial Baud Rate

The FLEXI PRO default baud rate is 115200. If the setting is changed and saved in the drive's non-volatile RAM memory, the drive will use the saved baud rate at power up.

In the event of a connectivity problem, for example, you may want to try using a lower baud rate.

#### Procedure – Modifying the Serial Baud Rate

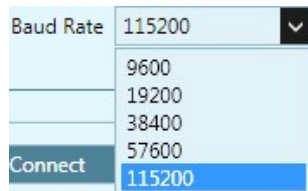
To modify baud rate settings, the change must be made in **both** the drive and Flexi SUITE software.

1. Change the baud rate in the drive:
  - Go to the **Terminal**.

- Type a command to change the baud rate; for example: **BAUDRATE 19200**
- Press **Enter**.

Communication is lost as soon as **Enter** is pressed, and Flexi SUITE goes offline.

2. Change the baud rate in Flexi SUITE.
  - Go to the **Communication** screen.
  - Select the same baud rate specified in Terminal for the drive.



**Figure 6-3. Serial Baud Rates**

- Press **Connect**.

If successful, Flexi SUITE will reconnect with the drive, and go back online.

## 6.3.2 CANopen Bit Rate

### Procedure – Establishing CANopen Communication

To establish, verify and modify CANopen communication, use Flexi SUITE over a **Serial** connection.

1. Be sure the CANopen interface is installed according to manufacturer instructions.
2. In the Flexi SUITE **Drive Information** screen, select the Command Interface Mode option: EtherCAT/CANopen.
3. In the Flexi SUITE **Terminal** screen, make sure the following settings are in effect:

```
COMMODE 1
CANBITRATE 3 (= 500 kbps)
```

## 6.4 Power Rating

When the motor is selected from the Flexi SUITE Motor Library, power rating parameters are pre-set and written to the drive. These parameters are manufacturer-defined and should not be manipulated by the user; if you want to make any changes to these parameters, contact Technical Support.

Use the Flexi SUITE **Power Rating** screen to view current and voltage values, and set some voltage parameters.

The following parameters are used to monitor and manipulate power rating.

VarCom	Description
DICONT	Drive continuous current. Defined in hardware. Read only.
DIPEAK	Drive peak current. Defined in hardware. Read only.
OVTHRESH	The level for detection of bus over-voltage. Defined in hardware. Read only.
UVMODE	Defines how the drive will respond to an under-voltage fault.
UVRECOVER	Defines how the drive will recover from an under-voltage fault.
UVTHRESH	The level for detection of bus under-voltage condition.
UVTIME	The duration of an under-voltage condition before latching a fault.
VBUS	Bus voltage (DC).
VBUSREADOUT	The actual bus voltage of the drive. Defined in hardware. Read only.

## 6.5 Feedback

When the motor is selected from the Flexi SUITE Motor Library, motor feedback parameters are pre-set and written to the drive. These parameters are manufacturer-defined and should not be manipulated by the user; if you want to make any changes to these parameters, contact Technical Support.

**FEEDBACKTYPE** defines the type of motor feedback used in the drive application.

The FLEXI PRO supports various motor feedback technologies and devices, including:

- BiSS-C encoder
- EnDat encoder
- HIPERFACE encoder
- Incremental A-quad-B encoder, with or without Hall sensors (or commutation tracks)
- Nikon encoder
- Resolver
- sensAR encoder
- Sine encoder
- Tamagawa encoder

### 6.5.1 Incremental Encoder

#### Types and Resolution

The FLEXI PRO supports several types of incremental encoders.

The following parameters are used to configure and monitor incremental encoders.

VarCom	Description
MENCTYPE	The type of encoder being used on the motor.
MENCRES	The resolution of the encoder, in number of lines per revolution of the motor. For an incremental encoder, $MENCRES \times 4$ equals the number of encoder counts per revolution.

The FLEXI PRO monitors all encoder signal wires, and generates an A/B Line Break fault (**r4** on the 7-segment display) if any wire is broken.

## Hall Signals

The FLEXI PRO supports single-ended (or open-collector) and differential Hall signals.

The following parameters are used to configure and monitor Hall commutation sensors.

VarCom	Description
HALLSTYPE	The type of Halls signals.
HALLS	Reads the state of the Hall signals.
HALLSINV	Inverts the polarity of individual Hall signals associated with motor phases UVW.

The FLEXI PRO monitors the state of the Hall signals, and will generate an Illegal Halls fault (**r6** on the 7-segment display) if either state 000 or 111 is detected. It will generate a Differential Halls Line Break fault (**r38**) if it fails to detect the differential Hall signals.

**Note:** Differential Hall signals can be used with Incremental A and B signals or as Halls only using the standard motor feedback C4 connector. If your application requires differential Hall signals with incremental A, B and index signals, contact Technical Support.

## Encoder Index

Encoders often have an additional channel, referred to as a marker channel, zero pulse, or index channel. This channel outputs one pulse per revolution, and is typically an extremely narrow pulse equal to about one-quarter of the width of an A or B channel pulse, but may be wider. The encoder index can be used for homing (absolute position reference) and for commutation alignment.

You can also use the command **Find Index** in the Flexi SUITE **Motor Feedback** screen to determine the position of the index signal.

The following parameter is used to set and monitor the encoder index.

VarCom	Description
MENCZPOS	The encoder index position.

The FLEXI PRO monitors the index signal wires, and will generate an Index Line Break fault (**r5** on the 7-segment display) if any wire is broken.

## Phase Finding

The Phase Finding procedure is used to initialize commutation for incremental encoder systems.

You can also use the command **Find Phase** in the Flexi SUITE **Motor Feedback** screen to determine the correct commutation.

The following parameters are used to configure phase finding.

VarCom	Description
PHASEFINDMODE	The method to be used for the commutation phase finding.
PHASEFIND	Starts the commutation initialization procedure for incremental encoder systems.
PHASEFINDGAIN	Adjusts the gain of the phase finding mechanism.
PHASEFINDI	Adjusts the current of the phase finding mechanism.
PHASEFINDTIME	The duration of the phase finding mechanism in a soft start.

### 6.5.2 Sine Encoder

Sine encoders are very similar to incremental encoders. The difference is that sine encoders send the A and B channels to the drive as 1V peak-to-peak sine-waves, while incremental encoders generate digital pulses.

### 6.5.3 sensAR Absolute Magnetic Encoder

The sensAR series of absolute magnetic encoders was developed by Motor Power Company.

The sensAR encoder has an electronic motor nameplate (MTP), which means a set of motor parameters is embedded in the encoder's non-volatile memory.

In firmware version 1.40.0 and later, the FLEXI PRO attempts to detect an electronic motor nameplate at power-up. If detected, motor and feedback parameters are transferred directly to the drive, and cannot be manipulated by the user.

The Motor Power Company PRO2 motor is typically equipped with a sensAR encoder.

The sensAR encoder has two different types:

**Absolute Single Turn** (FEEDBACKTYPE=12): After a power cycle the encoder retains its absolute position within one mechanical revolution. The multi-turn absolute position is 0.

**Absolute Multi-turn** (FEEDBACKTYPE=19): After a power cycle the encoder retains its absolute position within one mechanical revolution as well as the total number of motor revolutions since the last power cycle. A multi-turn encoder eliminates the need for homing after every power cycle.

The multi-turn encoder can store up to 65535 revolutions, provided it has an external backup battery. The encoder battery sits in a battery compartment on the cable between the motor and the drive. If the cable between the motor and the battery compartment is disconnected, or if the encoder does not receive voltage from the battery or the drive, the encoder loses the multi-turn number of resolutions; however, the single-turn absolute position is retained.

The following commands are used for configuring and enabling the multi-turn absolute encoder.

VarCom	Description
MTTURNRESET	Resets the position counter of an absolute multi-turn encoder, and clears battery no voltage fault.
IGNOREBATTFLT	Prevents a multi-turn absolute encoder from issuing a fault due to a dead, disconnected or missing backup battery, thus allowing the encoder to be used as a single-turn absolute encoder.

## Replacing the Multi-turn Encoder Backup Battery

The battery voltage level is measured during the power-up sequence only. If the battery voltage drops below the specified values during operation, no warnings or faults are issued until a power cycle is performed.

- If battery power drops below 3.15V, the encoder issues a battery low voltage **warning**. The battery should be replaced as soon as possible.

When replacing the battery, keep the drive under power to maintain the multi-turn position in memory during the replacement. Remove the old battery and insert a new one.

- If battery power drops below 3.0V, the encoder issues a battery no voltage **fault**; the drive detects the fault and disables the motor. Multi-turn data is no longer reliable.

Replace the battery: Shut off power to the drive. Remove the old battery and insert a new one. Power on the drive. Issue the command MTTURNRESET to reset the position counter of the multi-turn encoder. MTTURNRESET also clears the fault.

### 6.5.4 BiSS-C Interface

BiSS is an open interface for sensors and actuators. The BiSS-C standard allows vendors of such feedback devices to define a small set of commands that will cause the feedback device to perform certain functions. BiSS-C implementation in the drive is fully bidirectional.

The following commands are used to configure and monitor a BiSS-C feedback device.

VarCom	Description
BISSFIELDS	Sets the encoder multi-turn data length, multi-turn data resolution, single-turn data length, and single-turn data resolution values.
BISSINFO	Returns information about the BiSS-C device.

### 6.5.5 EnDat 2.2 Bidirectional Interface

The EnDat interface is a digital, bidirectional interface for encoders. It is capable of transmitting position values from incremental and absolute encoders as well as transmitting or updating information stored in the encoder, or saving new information. The serial transmission method requires only four signal lines. The data is transmitted in synchronism with the clock signal from subsequential electronics. The type of transmission (e.g., position values, parameters, diagnostics) is selected by mode commands that the subsequential electronics send to the encoder.

FLEXI PRO supports the EnDat 2.1 communication protocol, which is a subset of the EnDat 2.2 protocol. All EnDat 2.2 capable devices support the 2.1 protocol, including the commands and queries that are relevant to FLEXI PRO; accordingly, all EnDat 2.2 capable devices will work with FLEXI PRO.

EnDat 2.x can be used with the FLEXI PRO in following ways:

- **EnDat 2.x Communication Only:** for setups in which the drive relies only on the serial data from the feedback device as the source of position information.
- **EnDat 2.x with Sine/Cosine:** for setups in which (a) the drive performs encoder initialization and uses the serial data for position initialization, and (b) position update during operation is derived from the sine/cosine signals.

**Notes:**

- FLEXI PRO does not support the ability to query and set parameters during position-feedback operations.
- FLEXI PRO communication rate is 2 MHz.
- **EnDat 2.1 Encoder:** The value of PFB is calculated from the value of HWPOS and the sine/cosine signals during EnDat initialization upon power up, and upon clearing a feedback related fault. Initialization takes a few seconds. During this time, the value of PFB value is undetermined, and therefore the drive cannot be enabled.
- Initialization of the EnDat encoder takes about 2.5 seconds; during this process the message "ENDAT initialization incomplete" will be displayed if the drive status is queried (using command ST).
- The +5 VDC supply to the EnDat encoder must be switched off during (re)initialization. During the EnDat initialization, the FLEXI PRO switches off the +5 VDC it supplies to the encoder. However, if the encoder receives +5 VDC from a different source, and it is not switched off, initialization is likely to fail.

## 6.5.6 Encoder Simulation Output

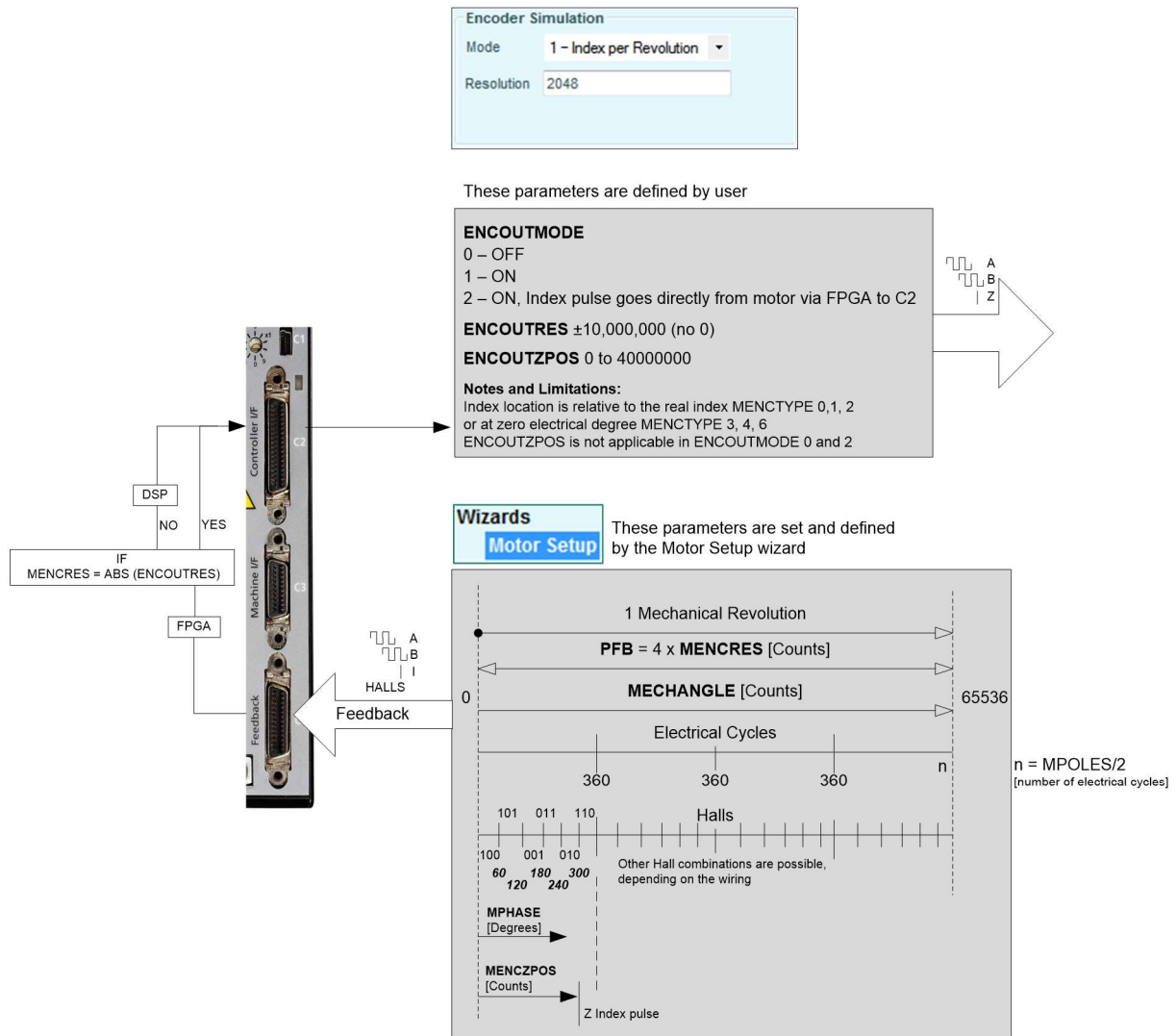
An encoder simulation output, also referred to as an **equivalent encoder output** (EEO) or a buffered encoder output, is available on the Controller I/F connector.

The following parameters are used to configure simulation.

VarCom	Description
ENCOUTMODE	Switches the encoder simulation on or off, and sets the functionality.
ENCOUTRES	The resolution, in equivalent lines-per-revolution, of the encoder simulation output
ENCOUTZPOS	The index offset value of the encoder simulation output.

The encoder simulation output process is described in Figure 6-4.





**Figure 6-4. Encoder Simulation Output Process**

### 6.5.7 Resolver

A resolver is a rotary transformer used to measure the motor shaft position.

The resolver has a primary winding, and two secondaries – a sine and cosine in sync with the motor rotation. The level of voltage on the sine and cosine waves correlates to the position of the shaft within one revolution.

Resolvers typically enable slower dynamic tracking than encoders.

The following parameters are used to configure and monitor resolver feedback.

VarCom	Description
RESAMPLRANGE	The acceptable range of resolver sine/cosine signals, expressed as a percentage, around their nominal value.
MRESPOLES	The number of individual poles in the resolver feedback device.
RESFILTMODE	Defines whether feedback position interpolation is performed on the resolver feedback in order to generate a continuous stream of data.

VarCom	Description
RESBW	The resolver conversion bandwidth. High bandwidth produces better dynamic tracking and less phase lag in high frequencies. Lower bandwidth results in better noise reduction. RESBW sets the most balanced value according to specific application requirements.

**Note:** The automatic tuning of the resolver reference amplitude takes about 3-5 seconds after the drive is powered on. During this time the drive cannot be enabled.

## 6.6 Resolver and Sine Encoder Calibration

### 6.6.1 Resolver and Sine Encoder Calibration Overview

When the FLEXI PRO is initially connected to a motor equipped with either a resolver or a sine encoder, FLEXI PRO parameters must be calibrated. Calibration is required during system assembly. Since analog component values might change over time, it is prudent to repeat the calibration procedure once every two years. Once the calibration procedure is completed, the calibration parameters are saved in the FLEXI PRO.

For the calibration, FLEXI PRO needs to read 128 sine signals either in one direction or back and forth.

Commonly a resolver will need 128 motor revolutions to generate the necessary 128 sine signals. Therefore the motor needs to be moved, at a limited speed, by a movement command.

Sine encoders can typically generate 128 sine signals well within one motor revolution. Therefore, the motor may be moved by hand for the calibration.

The following parameters are used to configure and monitor resolver/sine encoder calibration.

VarCom	Description
SININITMODE	Enables/disables the automatic calibration of sine encoder or resolver sine and cosine signals at power up.
SININIT	Activates a procedure that calibrates sine encoder or resolver sine and cosine signals. The calibration serves to reduce Harmonic errors in the sine encoder or resolver reading. The procedure averages sine encoder or resolver signals over several motor turns to determine the gain and offset correction.
SININITST	Reports the status of the sine encoder or resolver calibration procedure.
SINPARAM	Returns the parameters that are used for calibrating sine encoder or resolver sine and cosine signals. The parameters are in hexadecimal representation.

### 6.6.2 Motor Revolutions Required for Calibration

If your application has limited travel, you can run the motor back and forth 128 times. The length of each of these 128 movements must be at least 1.5 sine

cycles. If running the motor in one direction, the number of revolutions required for the calibration is calculated as follows:

$$\text{Resolver: } 128 \div \frac{\text{MRESPOLES}}{2}$$

Where MRESPOLES is the number of individual poles in the resolver feedback device.

For example, if MRESPOLES=4, the motor needs to make 64 revolutions for calibration.

$$\text{Sine encoder: } \frac{\text{MENCRES}}{128}$$

Where MENCRES is the number of sine cycles per motor revolution or per motor pitch.

### 6.6.3 Motor Speed Limitations During Calibration

During the calibration procedure, the motor speed must not exceed the following values:

**Resolver:** 3750 rpm

**Sine encoder:**  $\frac{3750}{\text{MENCRES}}$  rpm

### 6.6.4 Calibrating Resolver and Sine Encoder

#### Procedure - Resolver Calibration Using Terminal

1. In the Terminal interface, enter the sine/cosine calibration command:  
`SININIT` <Enter>
2. Enter a command to run the motor at a low speed, such as 800 rpm, for about 10 seconds, according to the operation mode of your application (current, velocity or position mode).
3. Enter the sine/cosine calibration status command:  
`SININITST` <Enter>
4. Wait until SININITST changes to 1, and then reverts back to 0.

**Example:** The motor runs in a velocity control loop at 600 rpm, and the calibration procedure is executed.

```

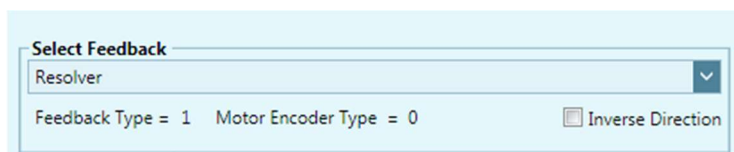
->OPMODE
0
->EN
->J 600
->sininit
->sininitst
1
->sininitst
1
->sininitst
0
->k
->|

```

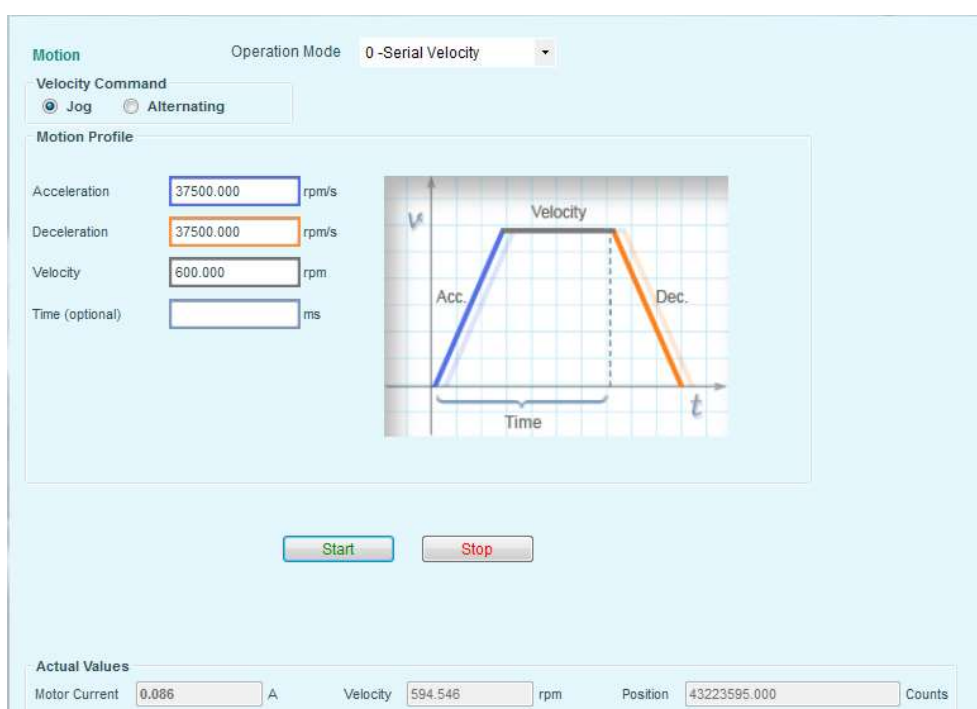
**Figure 6-5.**

**Procedure - Resolver Calibration Using Flexi SUITE**

1. In the **Feedback** screen, select Feedback > **Resolver**.

**Figure 6-6.**

2. In the **Motion** screen, set the parameters, for example:
  - Select Operation Mode > **0-Serial Velocity**.
  - Set Velocity to **600 rpm**.

**Figure 6-7.**

3. In the **Feedback** screen, set the following:

**Figure 6-8.**

- a. Note that Sine/Cosine Calibration Status is **0**.

**Figure 6-9.**

- b. Press the **Start** button to begin the calibration procedure.
- c. Note that Sine/Cosine Calibration Status changes to **1**.

**Figure 6-10.**

- d. Wait until Sine/Cosine Calibration Status reverts to **0**. Calibration is complete.

#### **Procedure - Sine Encoder Calibration Using Terminal**

1. In the Terminal interface, enter the sine/cosine calibration command:  
`SININIT` <Enter>
2. Enter a command to run the motor at a low speed, such as 100 rpm, according to the operation mode of your application (current, velocity or position mode). Alternately, move the motor by hand.
3. Enter the sine/cosine calibration status command:  
`SININITST` <Enter>
4. Wait until SININITST changes to 1, and then reverts back to 0.

**Example:** The motor runs in a velocity control loop at 6 rpm, and the calibration procedure is executed.

```

-->OPMODE
0
-->EN
-->J 6
-->sininit
-->sininitst
1
-->sininitst
1
-->sininitst
0
-->sininitst
0
-->sininitst
0
-->MENCRES
128 [LPR]
-->

```

**Figure 6-11.**

#### Procedure - Sine Encoder Calibration Using Flexi SUITE

Flexi SUITE does not currently support sine encoder calibration.

### 6.6.5 Sine Encoder and Resolver Diagnostics

#### Sine Encoder and Resolver Diagnostics Overview

When working with a sine encoder or a resolver, the FLEXI PRO measures the levels of the sine and cosine signals, and checks that they are within a certain range. When the signals are out of range, two possible faults can result: **r4** and **r8**.

If these faults occur, it is very useful to record the sine and the cosine signals, to determine whether or not they are valid.

#### Recording the Signals

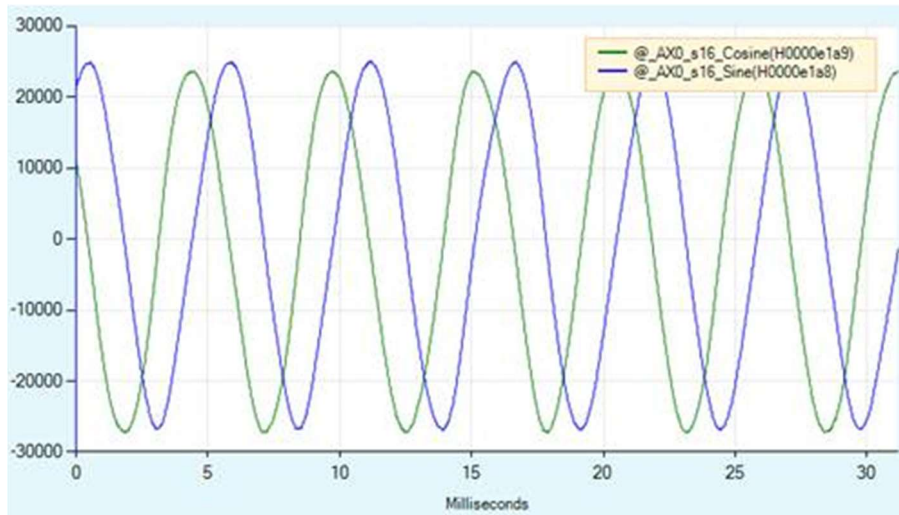
The sine and the cosine signals can be recorded by recording particular drive-internal data. A typical RECORD command is as follows:

```
record 1 1000 "@_AX0_s16_Sine.s16 "@_AX0_s16_Cosine.s16
```

This command records 1000 samples of the sine and the cosine values, at a intervals of 31.25  $\mu$ s (the drive's basic sampling rate).

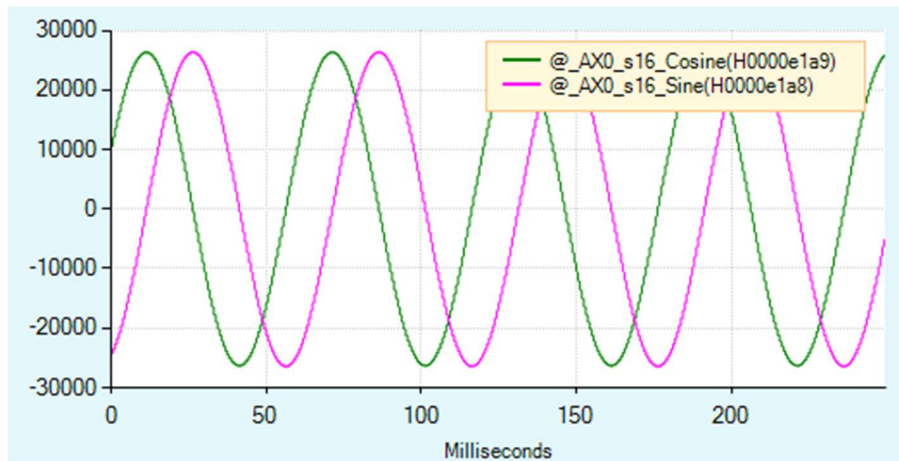
A typical recording of a sine encoder might look as shown in Figure 6-12.

The recorded data is presented in **internal drive units** (counts of the analog-to-digital converter).



**Figure 6-12. Example of Sine Encoder Recording**

A typical recording of resolver might look as shown in Figure 6-13:



**Figure 6-13. Example of Resolver Recording**

### Converting to Physical Values

The recorded data is in internal drive units, and needs to be converted to physical units; that is, the **input voltage** to the drive.

Since the physical sine and cosine signals are scaled differently for the sine encoder and the resolver, the following equations are used to convert the recorded data:

$$\text{Sine encoder: Input Voltage} = \frac{\text{Recorded Value}}{32768} \times \frac{10}{16.2}$$

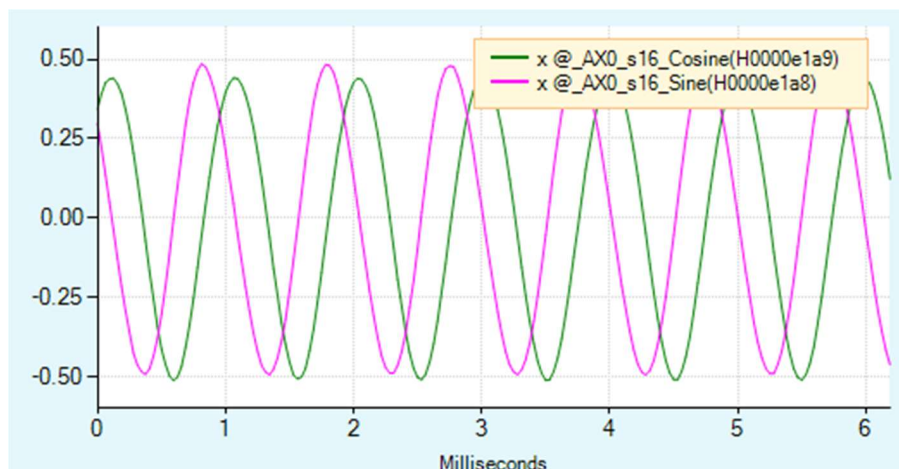
$$\text{Resolver: Input Voltage} = \frac{\text{Recorded Value}}{32768} \times \frac{10}{3.25}$$

### Examining the Plot

The recorded data can be scaled in the Flexi SUITE **Scope** screen.

When examining the sine and cosine signals from a sine encoder, you need to multiply the signals by 0.00001883 (calculated from  $1/32768 \times 10/16.2$ )

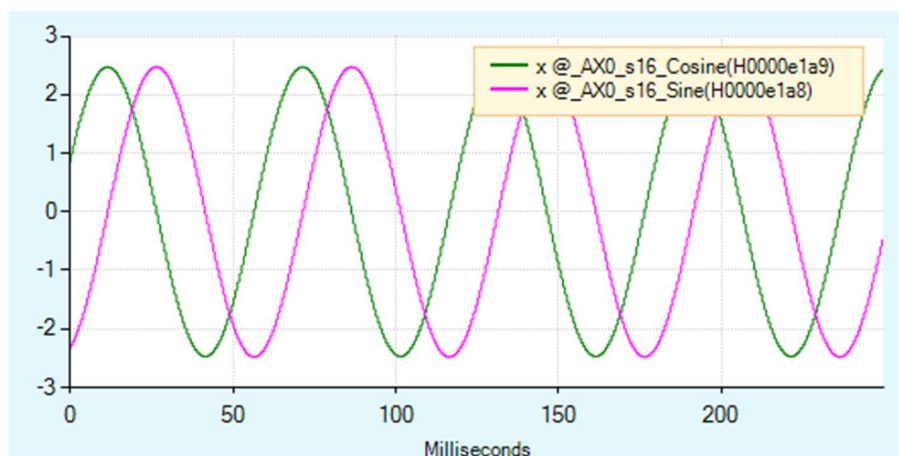
The resulting plot in the **Scope** screen will look similar to one shown in Figure 6-14. This plot shows the signal levels of the actual input signal (in volts). As expected, the sine encoder signals are close to 1V peak-to-peak.



**Figure 6-14. Example of Signals from Sine Encoder**

When examining the sine and cosine signals from a resolver, you need to multiply the signals by 0.0000939 (calculated from  $1/32768 \times 10/3.25$ ).

The resulting plot in the **Scope** screen will look similar to one shown in Figure 6-15. This plot shows the signal levels of the actual input signal (in volts).



**Figure 6-15. Example of Signals from Resolver**

## 6.7 Motion Units

The FLEXI PRO has configurable units of acceleration, velocity and position, for both linear and rotary motor systems. The unit definitions can be a user preference or a property of the specific motor being used.

Use the Flexi SUITE **Motion Units** task screen for viewing and defining motion units.

The following parameters are used to monitor and manipulate motion units.

VarCom	Description
UNITSROTPOS	The units of position variables in a rotary system.



VarCom	Description
UNITSROTVEL	The units of velocity variables in a rotary system.
UNITSROTACC	The units of acceleration and deceleration variables in a rotary system.
UNITSLINPOS	The units of position variables in a linear system
UNITSLINVEL	The units of velocity variables in a linear system.
UNITSLINACC	The units of acceleration and deceleration variables in a linear system.
PNUM PDEN	Conversion factors of the user-defined unit. They are used to multiply the motor revolution (rotary motors) or the motor pitch (linear motors), according to the type of motor (MOTORTYPE).
FBGDS	The conversion factor of the fieldbus device's <b>drive</b> shaft revolution.
FBGMS	The conversion factor of the fieldbus device's <b>gear</b> shaft revolution.

## 6.8 Current Foldback

The current foldback is a mechanism used by FLEXI PRO to protect the drive and motor from overheating due to excessive current. Current foldback is set independently for the drive and for the motor.

Current foldback limits the root mean square (rms) value of current to the drive and/or the motor.

When the motor is selected from the Flexi SUITE Motor Library, current foldback parameters are pre-set and written to the drive. These parameters are manufacturer-defined and should not be manipulated by the user; if you want to make any changes to these parameters, contact Technical Support.

Use the Flexi SUITE **Current Foldback** task screen for viewing and configuring motor and drive foldback parameters.

The following parameters are used to monitor and manipulate foldback properties.

VarCom	Description
IFOLD	Drive foldback current
DICONT	Drive continuous current
IFOLDFTHRESH	Drive foldback fault threshold
IFOLDWTHRESH	Drive foldback warning threshold
DIPEAK	Drive peak current
MIFOLD	Motor foldback current
MICONT	Motor continuous current
MIFOLDFTHRESH	Motor foldback fault threshold
MIFOLDWTHRESH	Motor foldback warning threshold
MIPEAK	Motor peak current

VarCom	Description
MFOLDD	Motor foldback delay time
MFOLDT	Motor foldback time constant
MFOLDR	Motor foldback recovery time
MFOLDDIS	Motor foldback

## 6.9 Digital Inputs

The FLEXI PRO has eight regular opto-isolated inputs and three fast opto-isolated inputs.

- Regular I/Os have a propagation delay in the range of several microseconds to several tens of microseconds.
- Fast I/Os have a sub-microsecond propagation delay.

Use the Flexi SUITE **Digital IOs** task screen to configure and view the state of the digital inputs.

The following parameters are used to configure and monitor the digital inputs.

VarCom	Description
IN	Reads the state of a specified digital input.
INPUTS	Reads the state of all digital inputs.
INMODE	Defines the functionality of the digital input.
ININV	Inverts the polarity of a specified input.

Flexi SUITE includes a **Drive Script** tool for programming instructions for digital inputs. These scripts can modify drive behavior while a machine is in operation, such as increasing or reducing acceleration, initiating a movement, setting a variable, or switching operation modes. Refer to the section in the Flexi SUITE manual, [Digital Input Activation of Drive Scripts](#).

## 6.10 Digital Outputs

The FLEXI PRO **AP** and **AF** models have four regular opto-isolated outputs and two fast opto-isolated outputs. The FLEXI PRO **EC** and **EB** models have six regular opto-isolated outputs.

- Regular I/Os have a propagation delay in the range of several microseconds to several tens of microseconds.
- Fast I/Os have a sub-microsecond propagation delay.

Use the Flexi SUITE **Digital IOs** task screen to configure and view the state of the digital outputs.

The following parameters are used to configure and monitor the digital outputs.

VarCom	Description
OUT	Reads the state of a specified digital output.
OUTPUTS	Reads the state of all digital outputs

VarCom	Description
<a href="#">OUTMODE</a>	Defines the functionality of the digital output

## 6.11 Analog Inputs

The FLEXI PRO supports either one 16-bit analog input or two 14-bit analog inputs. Both types of inputs are differential.

**Note:** One of the digits in the FLEXI PRO part number indicates whether the drive supports one or two analog inputs.

The analog input is used to send commands to the drive by means of analog voltage. The analog commands can control the velocity of the motor or the current to the motor. Analog commands can be used when the FLEXI PRO is operating in Analog Velocity mode (OPMODE 1) or Analog Current mode (OPMODE 3).

Use the Flexi SUITE **Analog Input 1** pane (and **Analog Input 2** if available) in the **Analog IOs** screen to set the analog input properties and to monitor the input value.

### 6.11.1 Analog Input 1

**Analog Input 1** serves as the analog command for the Analog Velocity (OPMODE 1) and Analog Current (OPMODE 3) operating modes. This functionality cannot be changed.

The following parameters are used to configure and monitor analog input 1.

VarCom	Description
<a href="#">ANIN1OFFSET</a>	The DC voltage offset on the analog input.
<a href="#">ANIN1DB</a>	The deadband range of analog input 1.
<a href="#">ANIN1LPFHZ</a>	A low-pass filter applied to the analog input.
<a href="#">ANIN1</a>	The voltage at the analog input. Read only.
<a href="#">ANIN1ZERO</a>	Causes the value of the analog input 1 signal to become 0 by modifying the analog offset value.

### 6.11.2 Analog Input 2

**Note:** Analog 2 is not available on all drive models.

When a second analog input is available on the drive, Analog Input 2 can be used as an analog current limit. In such a configuration, the parameter ANIN2SCALE is used to set the scaling of the current limit, in units of amperes per volt.

The following parameters are used to configure and monitor analog input 2.

VarCom	Description
<a href="#">ANIN2MODE</a>	Defines the functionality of the second input.
<a href="#">ANIN2LPFHZ</a>	This value is a low-pass filter applied to the analog input. This is useful for filtering high frequency noise from the input, or for limiting the rate of change of that signal.
<a href="#">ANIN2OFFSET</a>	The DC voltage offset on the analog input.

VarCom	Description
ANIN2DB	The deadband range of analog input 2. This is useful for preventing the drive from responding to voltage noise near the zero point of the analog input.
ANIN2	The voltage at the analog input. Read only.
ANIN2ZERO	Causes the value of the analog input 2 signal to become 0 by modifying the analog offset value.

### 6.11.3 Using Analog Inputs for Velocity Command and Current Limit

#### Procedure – Using Analog Inputs as Velocity Command and Current Limit

Use the following procedure in Flexi SUITE to configure the FLEXI PRO to work with **analog input 1** as the velocity command and **analog input 2** as the current limit.

**1.** Define the Operation Mode.

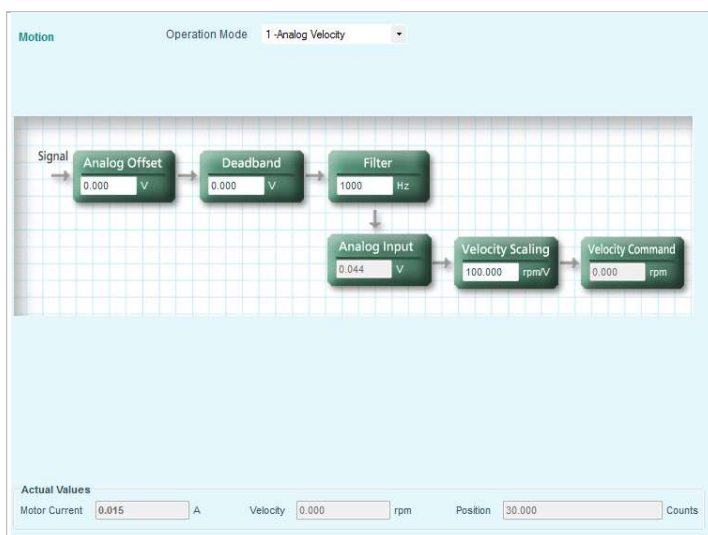
Activate the **Motion** screen, and select Operation mode: **Analog Velocity** (OPMODE 1).

When working in Analog Velocity mode, a signal is applied to analog input 1, and the drive translates it into a velocity command.

**2.** Define the Velocity command scaling.

Velocity command scaling is a user-defined ratio, which the drive uses to translate the analog input into a velocity command.

In the example shown here, scaling is set to generate a velocity command of 100 rpm per each volt.

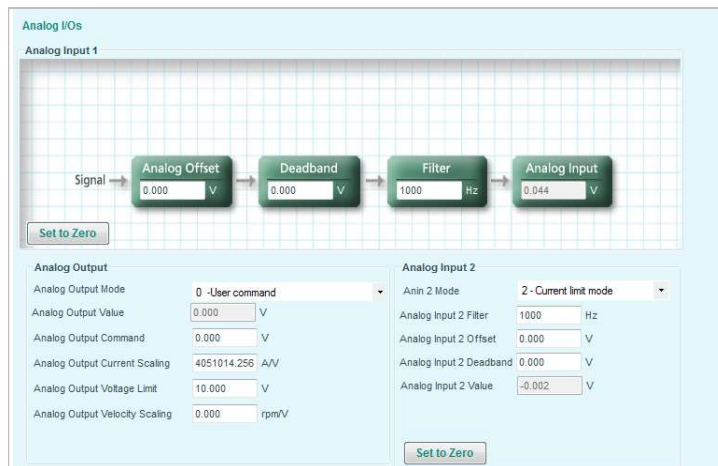


**Figure 6-16. Velocity Command Scaling**

**3.** Define the function of Analog Input 2.

Activate the **Analog I/Os** screen.

Define analog input 2 as the current limiter: in the **Analog Input 2** pane, select **Current Limit** mode (ANIN2MODE 2).



**Figure 6-17. Analog Input 2 as Current Limiter**

4. Define the scaling of the Analog Current command.

Open **Terminal**.

Define the parameter ANIN2ISCALE to set the scaling of the analog current command from input 2.

In the example shown here, scaling is 0.5A per each volt. The drive will calculate the current limit accordingly.

```
Terminal
-->anin2iscale 0.5
-->f
```

**Figure 6-18. Analog Current Scaling**

**Note:** Since both drive parameter ILIM and analog input 2 define current limit, the drive recognizes the lower value of the two as the current limit at any given time. To read the actual limit, use ILIMACT.

**Note:** Drive parameters ACC and DEC provide the limits for acceleration and deceleration, respectively. If analog input 1 (when used for velocity commands) generates a rate greater than ACC or DEC, the drive will not exceed the values of ACC and DEC.

## 6.12 Analog Output

The FLEXI PRO also has an analog output that can be set to output a voltage equivalent to the value of certain parameters.

Use the Flexi SUITE **Analog Output** pane in the **Analog IOs** screen to set the analog output properties and to monitor the output value.

The following parameters are used to configure and monitor the analog output.

VarCom	Description
ANOUTMODE	Defines the function of the analog output.
ANOUT	Displays the analog output value (in volts), as set by ANOUTMODE. Read only.
ANOUTCMD	The analog output command (in volts) set by user in ANOUTMODE 0.
ANOUTISCALE	The scaling of the analog output voltage that represents the motor current (I) or the current command (ICMD).
ANOUTLIM	The analog output command voltage limit for all modes.
ANOUTVSCALE	The scaling of the analog output voltage that represents the actual velocity (V) or the velocity error (VE)
OUTMODE	Defines the condition that will activate the specified digital output.

## 6.13 Homing

The FLEXI PRO provides numerous methods for homing the motor.

The parameter HOMETYPE defines when direction of motion is reversed during homing, the homing trigger (e.g., switch, index), and other conditions.

Homing types 1 through 14, 17 through 30, and 33 through 35 are standard homing methods, as defined in CiA 402.

Additional homing types have been defined per customer requests.

Use the Flexi SUITE **Homing** screen for defining and executing the homing procedure.

The following parameters are used to define and execute the homing procedure.

VarCom	Description
AUTOHOME	Defines whether automatic homing will be performed at power up.
HOMEACC	The value of acceleration and deceleration during the homing process.
HOMECMD	Starts the homing process.
HOMECMD 0	Stops the homing process.
HOMEOFFSET	Sets an offset, in counts, for the Home position.
HOMESPEED1	The initial velocity used in the homing process during the search for limit switches, home switches, and hard stops.
HOMESPEED2	The velocity used in the homing process during the search for the homing trigger, which may be an index mark, a limit switch transition, a home switch transition, or another source (as defined by HOMETYPE).
HOMESTATE	Displays the current state of system homing.
HOMETYPE	Defines the type of homing process that will be performed.

### 6.13.1 Home at Index with Motor Resolver

Homing on index mark can be used with resolver motor feedback.

Homing methods: 1-14, 33, 34, -8, -12, -33, -34, -40, -44, -65, -66, -97, -98).

The location of the resolver index mark is where the motor mechanical angle (MECHANGLE) is 0.

To achieve greater accuracy of the homing procedure (i.e., minimum PFB counts from MECHANGLE 0), reduce the value of HOMESPEED2.

### 6.13.2 Home at Index with Single/Multi-Turn Encoders

Homing on the index mark can also be used with absolute multi-turn and absolute single-turn feedback devices. The location of the index mark for the purpose of homing is the zero position of the single-turn data.

Homing methods: 33, -9, -10, -13, -14, -34, -65, -66, -97, -98

In these methods, HOMESPEED1 is used until an index, limit switch, or hard stop is detected.

If a limit switch or hard stop is encountered before the index is reached, movement is reversed at HOMESPEED2 until the index is detected.

However, if the index is reached first, at HOMESPEED1, the accuracy of the home location may be inadequate.

To ensure good homing accuracy for these methods, it is recommended to use a lower value of HOMESPEED1.

### 6.13.3 Home at Positive Edge of Home Switch

Homing methods: 24, 28

In some instances, the positive edge is reached at HOMESPEED1, which may be too fast, resulting in a less accurate home location.

To improve the homing accuracy for methods 24 and 28, it is recommended to instead use homing methods **-24** and **-28**. These methods include a reversal of movement at HOMESPEED2 until the required event occurs.

## 6.14 Disable Mode

The disabling of the drive may be the result of an explicit command from the motion controller or the drive's own response to a fault condition. When the drive becomes disabled, the Disable Mode function can be used in certain cases to bring the motor to a fast stop before power to the motor is shut off. This reduces the amount of motor coasting.

Use the Flexi SUITE **Disable Mode** screen to select the methods and parameters to be used for stopping the motor when the drive becomes disabled.

The Disable mode consists of two mechanisms: **Active Disabling** and **Dynamic Braking**.

VarCom	Description
DISMODE	Defines how the drive will respond when it becomes disabled.
DISMODE 0	No active disabling; no dynamic braking.

VarCom	Description
DISMODE 1	No active disabling; dynamic braking on fault only.
DISMODE 2	No active disabling; dynamic braking on any disable.
DISMODE 3	Active disabling on fault*; no dynamic braking.
DISMODE 4	Active disabling on fault*; dynamic braking on fault only.
DISMODE 5	Active disabling on fault*; dynamic braking on any disable.

\* **Note:** Faults that require immediate disable (to prevent drive damage) and feedback faults that might cause a commutation error (runaway motor condition) cannot issue Active Disabling.

Three parameters affect the behavior of the disabling and braking.

VarCom	Description
DISSPEED	Defines the velocity threshold below which the motor is considered stopped and the Active Disable timer starts the countdown to disable. The motor velocity must remain below this threshold for at least 50 ms for the motor to be considered stopped.
DISTIME	Defines the continuous time the motor must remain below DISSPEED before the drive is disabled. The DISTIME counter begins only after motor velocity has been below DISSPEED for at least 50 ms.
DECSTOP	Defines the deceleration rate of the ramp down.

### 6.14.1 Active Disable

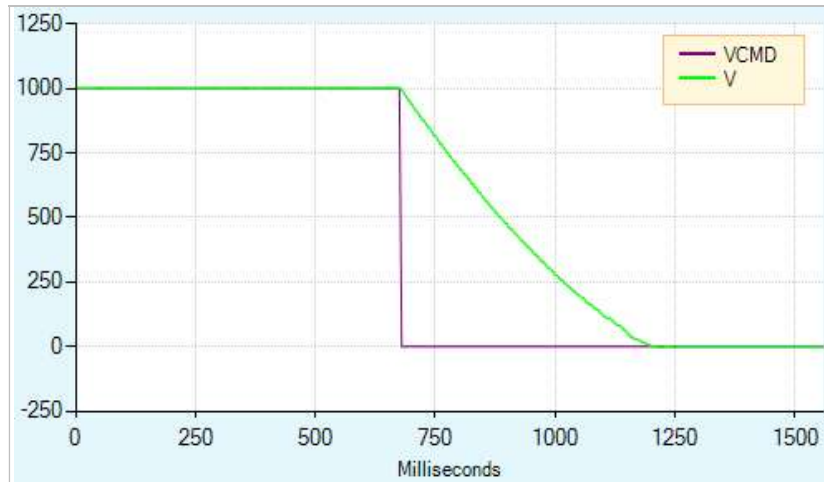
Active Disable prevents motor coasting while the axis is disabled.

The Active Disable mechanism brings the motor to a stop by means of a controlled ramp down to zero velocity, and then disables the drive.

**Note:** Active Disable cannot be applied when the drive is in a current control mode (OPMODE 2 or OPMODE 3); it works in all other operation modes.

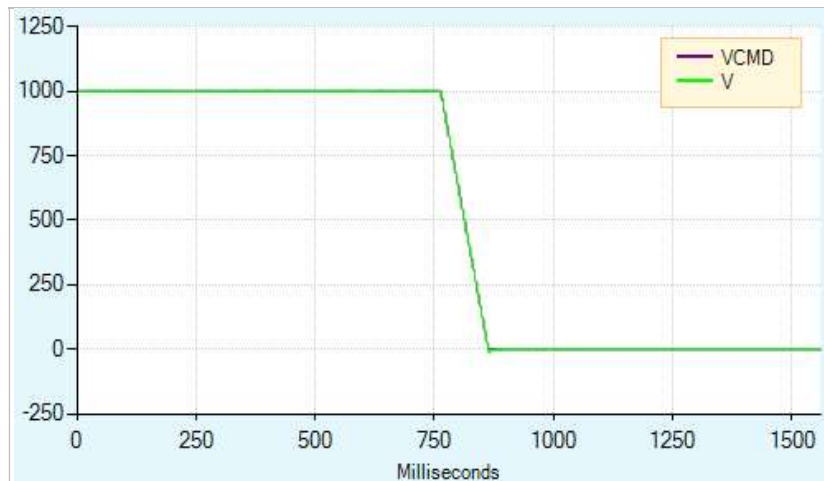
Figure 6-19 shows how motor coasting occurs when Active Disable is not used. As soon as the drive is disabled, the velocity command is set to zero. The actual velocity then decreases as a function of the inertia and friction.





**Figure 6-19. Disabling Without Active Disable**

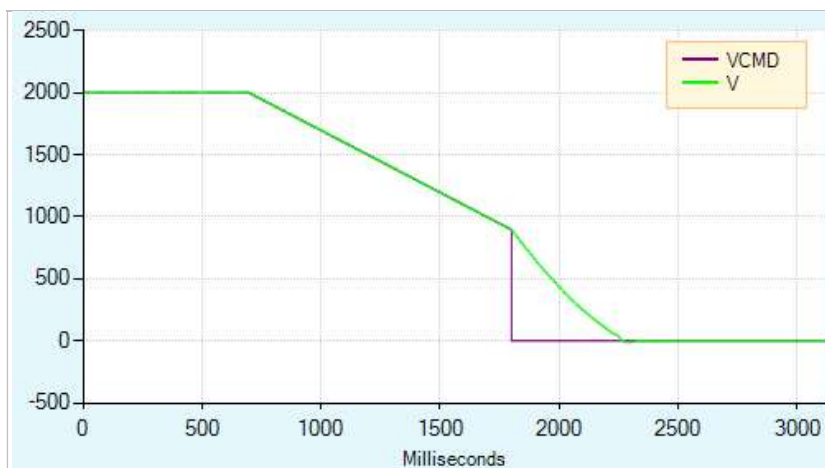
Figure 6-20 illustrates what happens when Active Disable is engaged. As soon as the drive receives the disable command, the velocity command is ramped down to zero, and only then is the drive disabled.



**Figure 6-20. Disabling With Active Disable**

Figure 6-21 shows the effect of DISSPEED and DISTIME. In this example, DISSPEED is set to 1000, and DISTIME is set to 1 ms. After the motor speed remains below 1000 for 100 consecutive background cycle, and the time defined by DISTIME elapses, the drive is disabled and the motor coasts to a stop.

In this example, approximately 110 ms elapse from the time the motor velocity goes below 1000 and the time the drive is disabled.

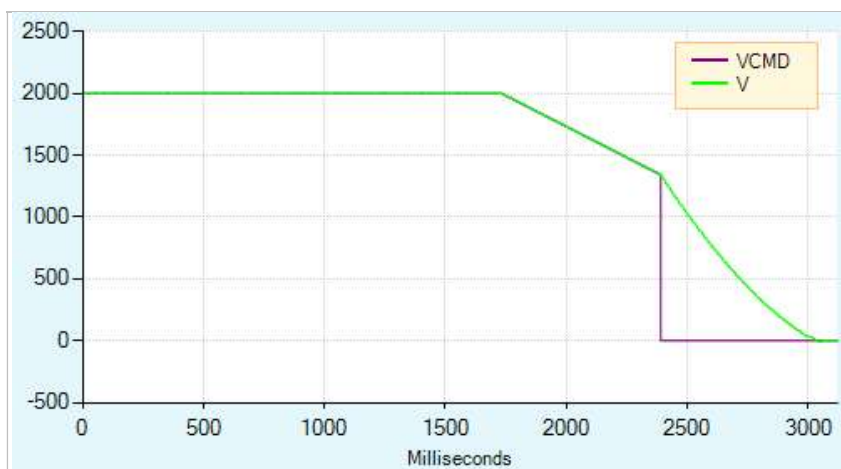


**Figure 6-21. Effect of DISSPEED and DISTIME on Active Disable**

During the Active Disable ramp down, the drive ignores any new motion commands.

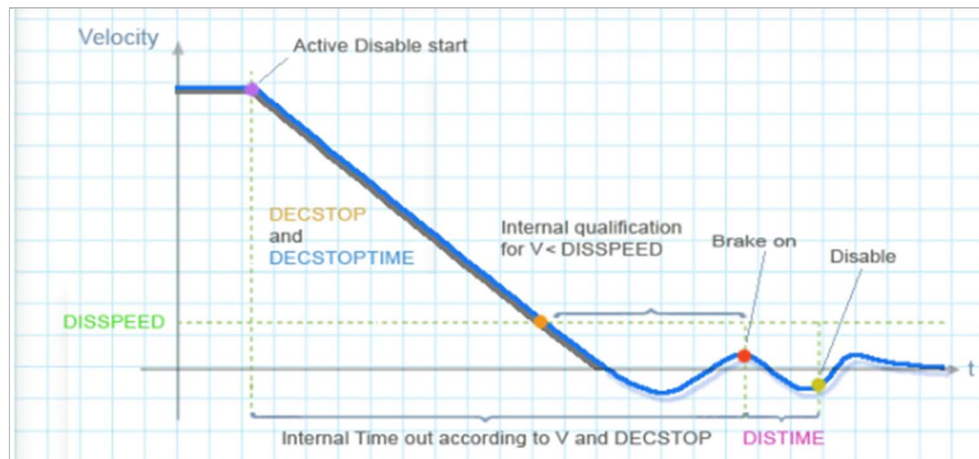
If an additional disable command (VarCom K) is issued during the ramp down, the ramp down process is aborted and the drive is immediately disabled.

Figure 6-22 shows the effect of a second disable command. In this example, DISSPEED is set to 1000, and a second disable command is issued before the motor speed has ramped down to that level.



**Figure 6-22. Effect of Second Disable Command on Active Disable**

The diagram in the Flexi SUITE Disable Mode screen illustrates the behavior of Active Disable.



**Figure 6-23. Disable Stop**

Notes:

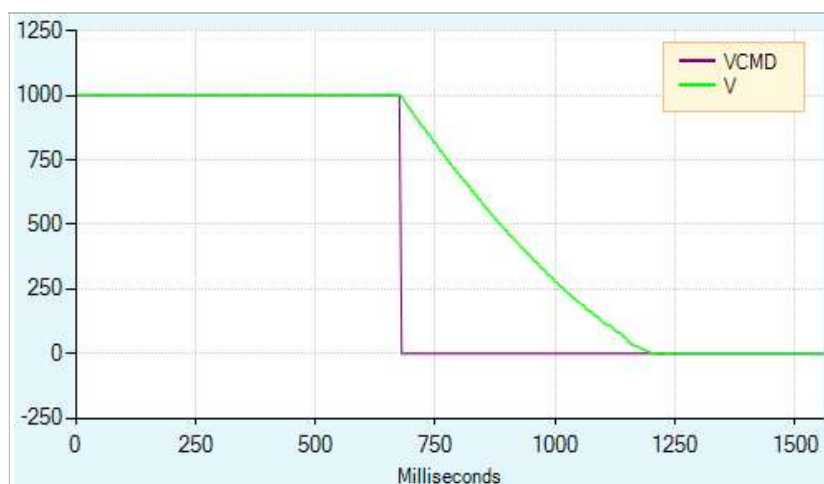
- If one of the digital outputs is configured for brake control, then the brake will be engaged as soon as the DISTIME timer begins counting.
- If the internal timeout (which is calculated according to the actual velocity and DECSTOP) expires, the ramp down mechanism will also abort, as indicated by **1** in the Disable Stop diagram.

### 6.14.2 Dynamic Brake

Dynamic braking is a mechanism that allows a disabled drive to hold the motor. Only the motor's back-EMF is used to apply the stopping current.

The variable ISTOP is used to set the maximum current allowed during the dynamic braking process.

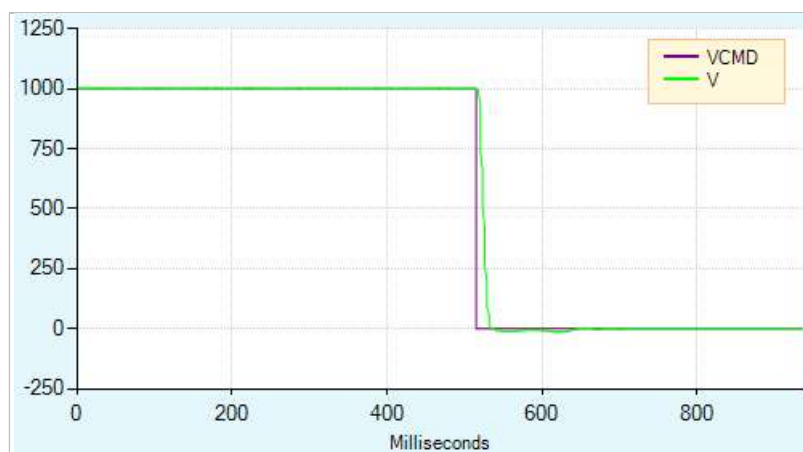
Figure 6-24 illustrates motor coasting, that is, no Dynamic Braking (and no Active Disable). The velocity command is set to 0 as soon as the drive is disabled. The actual velocity then decreases as a function of the system inertia and friction.



**Figure 6-24. Motor Coasting, Without Dynamic Braking**

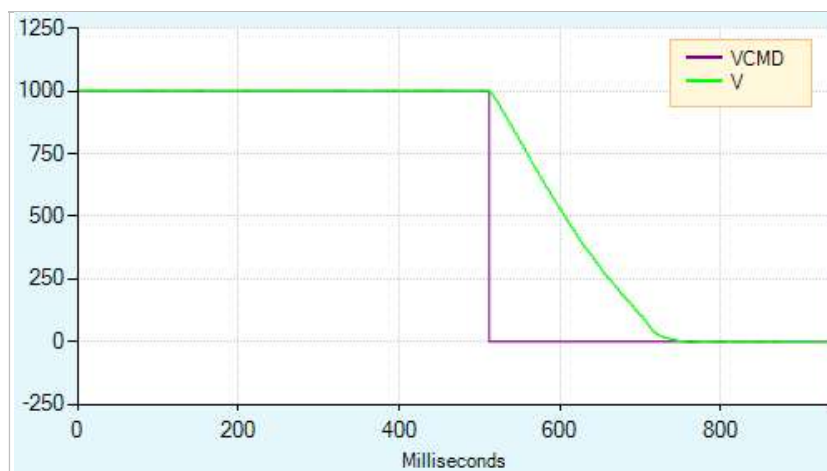
Figure 6-25 shows what happens when Dynamic Braking is engaged. As in the figure above, the velocity command is set to 0 as soon as the drive is disabled. However, the actual velocity ramps down as the braking is applied.

Unlike Active Disable, the velocity does not ramp down according to a motion profile. The ramp down rate is a function of the maximum current allowed (variable `ISTOP`) and the system inertia and friction.



**Figure 6-25. Dynamic Braking**

Figure 6-26 shows Dynamic Braking with a very low value of `ISTOP`. In this instance, it takes longer to bring the motor to a stop.



**Figure 6-26. Dynamic Braking with Low `ISTOP` Value**

In `DISMODE 4` and `DISMODE 5` both Active Disable and Dynamic Braking are supported. In these cases, Active Disable is used to bring the motor to a stop, and Dynamic Braking is activated after `DISTIME`.

## 6.15 Motor Brake Control via Relay

The FLEXI PRO 120/240 VAC models do not have sufficient amperage to activate a motor brake. The FLEXI PRO can be connected to a motor brake via a relay connected to digital output pins on either the Controller I/F interface or Machine I/F interface, and configured in Flexi SUITE.

Refer to [Motor Brake \(Optional\)](#) and to the procedure below.

**Note:** FLEXI PRO 400/480 VAC models can also be connected to a motor brake via a relay, and configured in the same manner as 120/240 VAC models. However, direct motor brake control on 400/480 VAC models can be more easily implemented through the dedicated connector (P4). When using the P4 connection, use the **Terminal** screen and VarCom instructions.

By default, the following conditions are in effect:

Output is <b>off</b>	Voltage to the brake is 0V	Brake coil is disengaged	Motor brake holds the motor shaft
Output is <b>on</b>	Voltage to the brake 24V	Brake coil is engaged	Motor brake releases the motor shaft

The polarity of the digital output can be altered to make the drive electronics match those of the motor control circuit.

The FLEXI PRO disable time is programmable by means of the DISTIME parameter. When the drive receives a Disable command, it first switches off the brake output and then waits for the brake disengage time before actually becoming disabled.

The brake engage time is not programmable. When the drive receives an Enable command, it simultaneously switches on the brake output and becomes enabled.

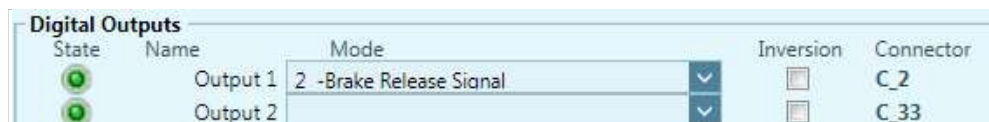
The drive needs a maximum of 1.5 milliseconds to become enabled, while a brake typically takes tens of milliseconds to disengage.

**Procedure - Configuring Digital Output to Control Brake**

To configure the digital output, perform the following procedure in Flexi SUITE.

1. Define the output.

Go to the **Digital I/Os** screen, and set an output (e.g., Output 1) to mode **2-Brake Release Signal**.



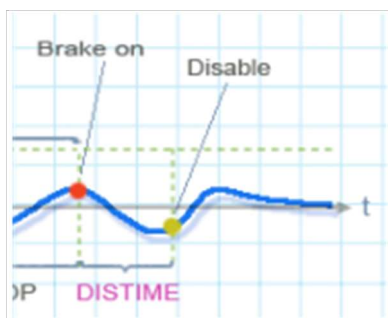
**Figure 6-27. Digital Output Settings for Motor Brake Control**

By default:

- When FLEXI PRO is enabled, the brake output is on.
- When FLEXI PRO is disabled, the brake output is off.

2. Go to the **Disable Mode** screen, and set the Active Disable Time (DISTIME). For example, set it to 30 ms.

DISTIME defines the period of time after the motor speed goes below the Active Disable Speed Threshold (DISSPEED) until the drive is disabled by the Active Disable function.



**Figure 6-28. Active Disable Time (DISTIME)**

Whenever a Disable command is executed, the FLEXI PRO immediately changes the brake output value, and waits the Active Disable Time (DISTIME) before disabling FLEXI PRO control.

Whenever a fault such as STO or Feedback Lost occurs, the drive immediately toggles the brake output value and disables FLEXI PRO control.

## 6.16 Motor Temperature Sensor

The FLEXI PRO supports both thermostat (on/off) and thermistor (temperature sensitive resistance) motor temperature sensors.

The following parameters are used to define the type of motor temperature sensor and the drive response to an over-temperature condition.

VarCom	Description
THERM	Indicates whether a motor over-temperature fault exists.
THERMODE	Defines how the drive responds to a motor over-temperature fault. If the motor does not have a temperature sensor, or if the sensor is not wired, set THERMODE to 3, so that the drive will ignore this fault.
THERMTYPE	Indicates whether the sensor is type PTC (positive temperature coefficient) or NTC (negative temperature coefficient). When using a thermostat (on/off motor temperature sensor), set THERMTYPE to 0 to define type PTC.
THERMREADOUT	Reads the resistance of the temperature sensor.

VarCom	Description
THERMTRIPLEVEL THERMCLEARLEVEL	<p>The motor over-temperature fault detection and clear mechanism is subject to a hysteresis mechanism. The fault will trip when the resistance passes a certain value, and can be cleared only when the resistance drops below a different value.</p> <ul style="list-style-type: none"><li>■ For a <b>PTC thermistor</b>, the motor over-temperature fault will trip when the resistance is equal to or greater than the THERMTRIPLEVEL. The fault can be cleared when the resistance is equal to or less than the THERMCLEARLEVEL.</li><li>■ For an <b>NTC thermistor</b>, the motor over-temperature fault will trip when the resistance is equal to or less than the THERMTRIPLEVEL. The fault can be cleared when the resistance is equal to or greater than the THERMCLEARLEVEL.</li><li>■ If the motor temperature sensor is a thermostat, the resistance is zero in normal state and infinite in fault state.</li></ul>

When the drive detects a motor over-temperature condition, the motor over-temperature fault is latched, and the 7-segment display flashes **H**.





# 7 Motor Setup

As of firmware version 1.40.0, the drive attempts to detect a motor feedback device and an electronic motor nameplate at power-up. If detected, certain motor and feedback parameters are transferred directly to the drive, and cannot be manipulated by the user.

If an electronic motor nameplate is not detected at power-up, the Motor screen allows you to select a motor from the Flexi SUITE databases (motor libraries). You can simply select the motor family and motor part number, and Flexi SUITE will prepare the appropriate motor and feedback parameters. The screen allows you to modify and send parameters to the drive, read parameters from the drive, and save parameters.

## 7.1 Motor Setup Wizard

The Flexi SUITE **Motor Setup Wizard** provides the quickest and easiest method for getting the drive and motor up and running. It configures the essential parameters and the current control loop for a motor without a load.

It is recommended that you use the Motor Setup wizard when connecting the host computer, drive and motor for the first time.

This chapter describes the functions and parameters that are configured during the setup and initialization of the motor.



**Disable the drive before manipulating motor and feedback parameters.**

Many parameters can be modified while the drive is enabled.

Exercise caution, however, as motor behavior will change.

If a parameter cannot be modified while the drive is enabled, Flexi SUITE will prompt you to disable the drive.

### Step 0 – Connection

Typically, the wizard begins at Step 0. If Flexi SUITE is already communicating with the drive, the wizard will begin at Step 1.

To connect to the drive, click **Search & Connect**.

Alternately, enter the port settings, and click **Connect**.

## Step 1 – Drive Identification

**Motor Setup**

---

**Step 1: Drive Information**

1. Review the drive information.
2. If necessary, click Restore Factory Default to restore the original drive parameters.
3. Optionally, enter a name for the drive. Press Enter after typing the name.

---

Drive Name

---

Drive Details		Drive Settings	
Drive Model	FPRO-0032AEC2-00	Drive Peak Current	12.7 A (9.0 Arms)
Serial Number	114M-0004746, December 2014	Drive Continuous Current	4.2 A (3.0 Arms)
Firmware Version	1.41.17	Feedback Device	sensAR Magnetic Encoder Single Turn
Control Board Version	DO		
Power Board Version	CT		
FPGA Version	EC5.90.01		

---

**Interface Mode**

Serial / Pulse / Analog  
 EtherCAT / CANopen

**Figure 7-1. Flexi SUITE – Motor Setup Wizard – Drive Information**

1. Review the drive information.
2. Enter a name for the drive, and press **Enter** after typing the name.  
The name field will change from blue to white, indicating the name has been sent to the drive.

This step also includes an option to restore the drive's factory settings: **Restore Factory Default**.

This step also shows and allows setting the **Command Interface Mode**:

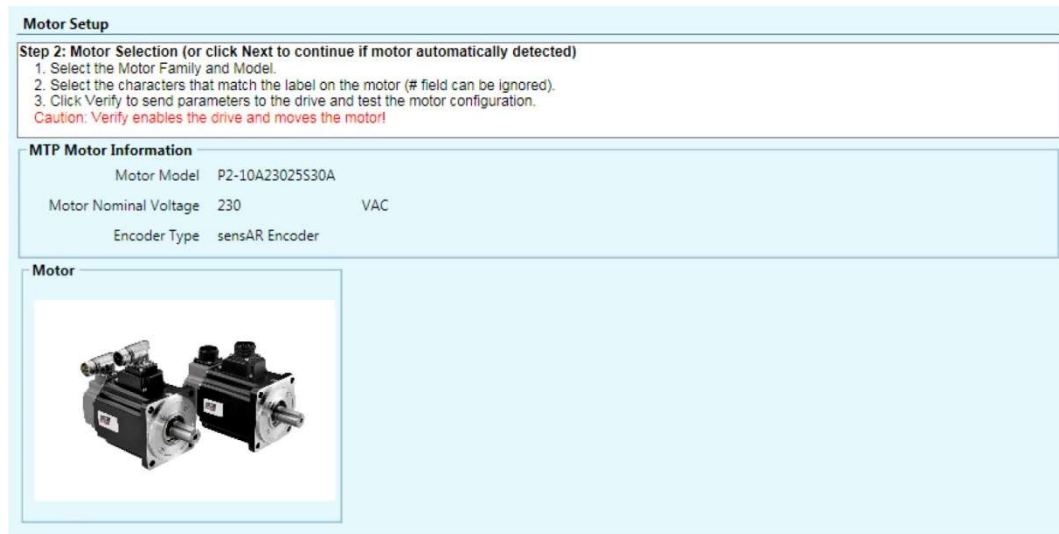
- **Serial/Pulse/Analog** indicates drive is active (Servo On) and motion commands are transmitted via a serial, pulse or analog interface. COMMODE 0.
- **EtherCAT/CANopen** indicates drive is active (Servo On) and motion commands are transmitted via an EtherCAT/CANopen interface. COMMODE 1.

For FLEXI PRO **AF**, **EC**, **EB** models, both interface options are available.

For FLEXI PRO **AP**, only EtherCAT/CANopen option is available.

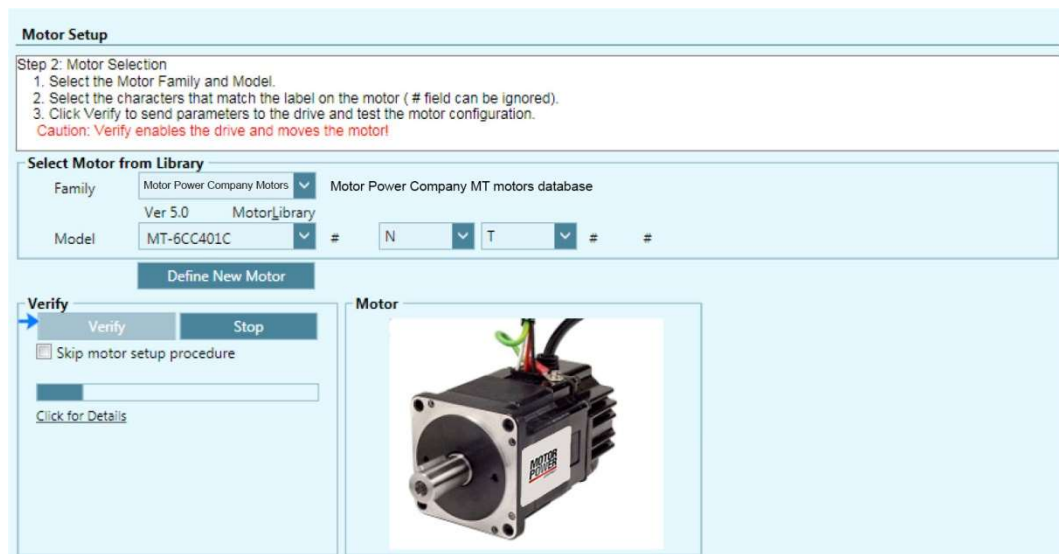
## Step 2 – Motor Identification and Initialization

If the drive detects an electronic motor nameplate, the parameters in this screen are set automatically and cannot be manipulated. Click **Next** to continue.



**Figure 7-2. Flexi SUITE – Motor Setup Wizard – Example 1**

If the drive does not detect an electronic nameplate, you need to select a motor from the Flexi SUITE database (library).



**Figure 7-3. Flexi SUITE – Motor Setup Wizard – Example 2**

1. Select the **Motor Family**
2. Select the **Motor Model**.
3. Select the characters that match the label on the motor (# means the field can be ignored).
4. Click **Verify** to send parameters to the drive and test the motor configuration.



**Verify** enables the drive and moves the motor!

If your motor is not listed in the default set of motor libraries, press **Define New Motor**, and use the [New Motor Wizard](#) to enter the parameters for your particular motor.

### Step 3 – Current, Velocity and Position Limits

Motor Setup Wizard suggests values for Low, Medium or High current and velocity limits, which are rounded to 25%, 50% and 75%, respectively, of the maximum range.

**Note:** If the limits are set too low, the Autotuning wizard might not produce the optimal result.

The wizard also allows you to set the position error threshold level, that is, the maximum value that will not produce a fault.

**Motor Setup**

**Step 3: Velocity and Current Limits and Maximum Position Error**

1. The suggested Low, Medium and High values are equal to 25%, 50% and 75% of the maximum range.  
 2. Select Low, Medium or High, or select User Defined and enter values.  
 3. Click Approve to send the values to the drive.

**Set Limits**

Low  Medium  High  User Defined

Current Limit (ILIM)	6.364 A	12.728 A	19.091 A	19.091 A
Velocity Limit (VLM)	1250.000 rpm	2500.000 rpm	3750.000 rpm	5000.000 rpm
Position Error Limit (PEMAX)	4194304 counts	2097152 counts	1048576 counts	1048576.0 counts

**Approve**

**Figure 7-4. Flexi SUITE – Motor Setup Wizard – Limits**

- Do either of the following to set velocity and current limits, and the position error limit:
  - Select the suggested **Low**, **Medium** or **High** values.
  - Select **User Defined**, and enter your preferred values.
- Click **Approve** to send the values to the drive.

If Current Limit or Velocity Limit is set to a user-defined value of 0, it will prevent motion from occurring.

If Position Error Limit is set to a user-defined value of 0, no position error limit is set, and no faults will be produced.

### Step 4 – Motor Direction

The Motor Setup wizard simplifies the process of defining the rotation direction for a positive command. Otherwise, VarCom instructions are required.

**Motor Setup**

**Step 4: Move and Set Direction**

1. To verify motor motion direction, click Negative or Positive.  
**Caution: Negative and Positive enable the drive and move the motor!**  
 2. To reverse the direction to match your system, select Inverse Direction.  
 3. To continue, click Approve Direction.

**Manual Move**

5 % of Motor Continuous Current

**Negative** **Positive**

Inverse Direction

**Approve Direction**

**Figure 7-5. Flexi SUITE – Motor Setup Wizard – Move and Direction**

1. To verify motor motion direction, click **Negative** or **Positive**.



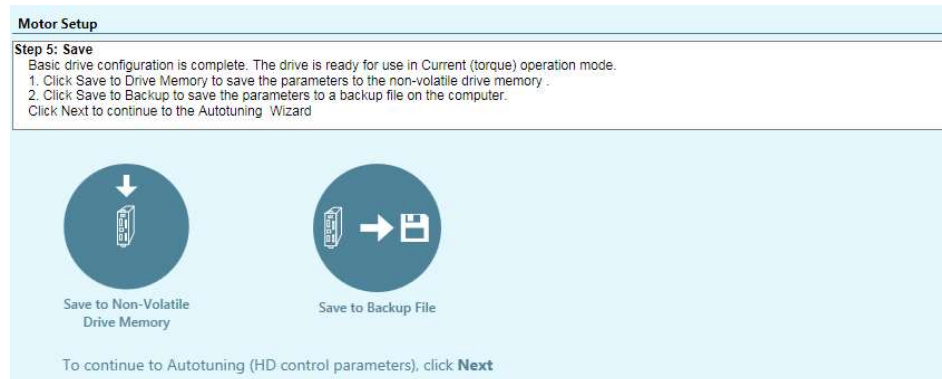
**Negative** and **Positive** enable the drive and move the motor!

2. To reverse the direction to match your system, click **Inverse Direction**.
3. To continue, click **Approve Direction**.

Refer to VarCom MPHASE and DIR.

### Step 5 – Save

It is recommended that you save parameters to the drive’s non-volatile memory and to a file on the host computer for backup.



**Figure 7-6. Flexi SUITE – Motor Setup Wizard –Save**

Do both of the following:

- **Save to non-volatile drive** memory to save the parameters from the drive’s RAM to the drive’s permanent memory.
- **Save to backup file** to save the parameters in drive RAM to a backup file on the computer. The parameters are saved in a text file with either TXT or SSV extension. The text file can be edited using Notepad or any other text editor.

### Next Step

Once the Motor Setup wizard is completed, the **Current** control loop is configured.

You are prompted to press **Next** to continue to the **Autotuning** wizard.

## 7.2 Drive Identification

Drive information is presented and confirmed in **Step 1** of the Motor Setup wizard.

The Flexi SUITE **Drive Info** task screen allows you to view drive properties and define the drive name.

The following parameters are used to view and configure drive information:

VarCom	Description
INFO	Hardware-defined. Returns the drive model and serial number, and version numbers of firmware, control board, power board and FPGA.

VarCom	Description
DRIVENAME	Optional, user-defined parameter. It is useful when an application has more than one drive. It is recommended that you provide a name for the drive that reflects the function it performs, such as Axis-1.

### 7.3 Motor Identification

Motor selection and properties are presented and confirmed in **Step 2** of the Motor Setup wizard.

The Flexi SUITE **Motor** task screen allows you to define and initialize the motor.

You can easily select the motor family and motor part number from the Flexi SUITE databases (motor libraries) and Flexi SUITE will prepare the appropriate motor and feedback parameters.

If your motor is not listed in the default set of motor libraries, use the **New Motor** wizard to define a new motor.

The following parameter is used to view and configure motor identity:

VarCom	Description
MOTORNAME	If the motor is selected from a library in the Flexi SUITE database, the name is automatically assigned. Motor names can also be assigned and modified by users.  The motor name always begins with a quotation mark ("). For example: "MT-6CC401C

### 7.4 Motor Initialization

Motor commutation is performed in **Step 2** of the Motor Setup wizard.

The command **MOTORSETUP** initiates a quick commissioning procedure for setting the parameters that define motor commutation.

In the Flexi SUITE **Motor** screen, use the **Verify** and **Stop** buttons to start and stop the MOTORSETUP process.

During the initialization process, the rotary motor moves forward/backward about two mechanical revolutions in forced commutation, which does not require feedback. MOTORSETUP detects the state of Hall switches, index position and polarity, the order of the electrical phases, the direction of motor movement, and the feedback resolution per electrical revolution.

Based on the data collected, the drive updates the parameters MFBDIR, MPHASE, MPOLES, MENCRES and MENCZPOS, making it possible to begin working with the motor and wiring that are connected to the drive.

If the procedure fails, the original values of MFBDIR, MPHASE, MPOLES, MENCRES and MENCZPOS will be restored.

#### Notes:

- Not all parameters are updated by the procedure. It depends which parameters are in use, as determined by MENCTYPE.
- The value of MICONT is very important, since this value sets the limit for the current used during the procedure.

### Procedure - MOTORSETUP

To execute the Motor Initialization procedure, do the following:

1. Disable the drive.
2. Clear any faults in the drive.
3. Enter the command **MOTORSETUP**.
4. Enable the drive.

The procedure will begin and perform several steps.

Once the Motor Initialization procedure is started (even when the drive is disabled) the 7-segment flashes **A t 1**.

When the setup finishes successfully, the display returns to its normal state; if the setup fails, the display shows **-5**.

To cancel the procedure, enter the command **MOTORSETUP 0**

Any parameters that were modified by the MOTORSETUP procedure will be restored to their previous values.

To view the status of the procedure, enter the command MOTORSETUPST.

## 7.5 Current Limits

Current limits are modified and/or confirmed in **Step 3** of the Motor Setup wizard.

The Flexi SUITE **Limits-Current** task screen allows you to define current limits.

The following parameters are used to define the maximum current for the system and to set the current limits for an application.

VarCom	Description
DIPEAK	The rated peak current of the drive. Hardware defined. Read only.
MIPEAK	The rated peak current of the motor. The value can be manipulated.
IMAX	This value is the maximum current for a drive and motor combination, as calculated by the software. Read only.
ILIM	The current limit for the application. This parameter lets you limit the drive's peak current to a value lower than DIPEAK.
ILIMACT	The actual drive current limit. Read only.

## 7.6 Velocity Limits

Velocity limits are modified and/or confirmed in **Step 3** of the Motor Setup wizard.

The maximum speed that the drive can compute is hardware defined.

The Flexi SUITE **Limits-Velocity** task screen allows you to define velocity limits.

The following parameters are used to define the maximum velocity for the system and to set the velocity limit for an application.

VarCom	Description
MSPEED	The maximum motor speed, as defined in the motor datasheet.

VarCom	Description
VMAX	This value is the maximum velocity for a drive and motor combination. VMAX is based on maximum motor speed. Read only.
VLIM	The maximum application velocity. This parameter lets you limit the motor's maximum velocity to a value lower than VMAX.

## 7.7 Position Limits

Position limits are modified and/or confirmed in **Step 3** of the Motor Setup wizard.

The Flexi SUITE **Limits-Position** task screen allows you to define position limits.

The following parameters are used to define positioning limit mechanisms and error tolerances.

VarCom	Description
PEMAX	The maximum position error allowed without producing a fault, in counts.
PEINPOS	The window of tolerance for declaring an "in position" state.
INMODE # 5	Defines digital input # as the signal that indicates whether the position limit has been reached in the positive direction.
INMODE # 6	Defines digital input # as the signal that indicates whether the position limit has been reached in the negative direction.
LIMSWITCHPOS LIMSWITCHNEG	Indicate the status of all positive and negative limit events. Read only.
POSLIMMODE	Enables and disables the use of software position limits and/or <b>transient</b> position limits and/or <b>homing</b> limits.
POSLIMPOS POSLIMNEG	The maximum and minimum values, in counts, for the software position limits.

## 7.8 Motor Direction

When the motion command is positive, the direction of motion can be explicitly reversed. The positive direction for a rotary motor, for example, can be either clockwise or counterclockwise, depending on the application requirements.

Motion direction is tested and/or reversed and/or confirmed in **Step 4** of the Motor Setup wizard.

The following parameters are used to define motor direction:

VarCom	Description
DIR	The feedback positive direction. When DIR=1, parameter V is inverted and the positive direction of PFB is inverted. Motor rotation is not changed.



VarCom	Description
MPHASE	The resolver/encoder phase relative to the standard commutation table. To reverse the direction of rotation, 180 degrees is added to the value of MPHASE.
MFBDIR	Defines several direction and polarity settings. MFBDIR values are set by the MOTORSETUP procedure.

**Caution!**

The values of DIR and MPHASE must be changed at the same time, before the drive is enabled, otherwise a commutation fault (motor runaway) may occur.

## 7.9 New Motor Wizard

**Note:** If the drive detects an electronic motor nameplate, the New Motor wizard is not available when operating Online.

If you are using a motor whose parameters are not available in the default sets of motor libraries in Flexi SUITE, you can use the **New Motor** wizard to define your motor. Once defined, the new motor is added to the set of **User Motors** in the motor library.

The wizard can be activated either from the Motor screen, or during the Motor Selection step in the Motor Setup wizard.

Click on **New Motor** to activate the wizard.

**Note:** It is recommended that you activate the **New Motor** wizard from the Motor screen, because parameters cannot be saved to the motor library when the wizard is activated from Motor Setup.

A series of dialog boxes prompts you to provide motor parameters, which you should be able to extract from the motor datasheet.

The New Motor wizard allows you to select units and enter values according to the information in your motor's datasheet. In addition, the wizard includes a unit conversion function. Once you have entered all data in the wizard, Flexi SUITE converts the units into the equivalent values used by the drive. These converted values are maintained in the motor library and in the drive.

## Step 1 – Motor Specification

**New Motor**

Rotary Motor     Linear Motor

Motor Name: Demo Motor

Motor Picture File (optional): [ ] ...

Motor Peak Current: 15.00    Ampere peak

Motor Continuous Current: 5.0    Ampere peak

Motor Maximum Speed: 4500    rpm

Motor Inductance: 4.2    mH

Motor Resistance: 1.87    Ohm

Motor Poles: 2

Torque Constant: 0.016    Nm / Ampere peak

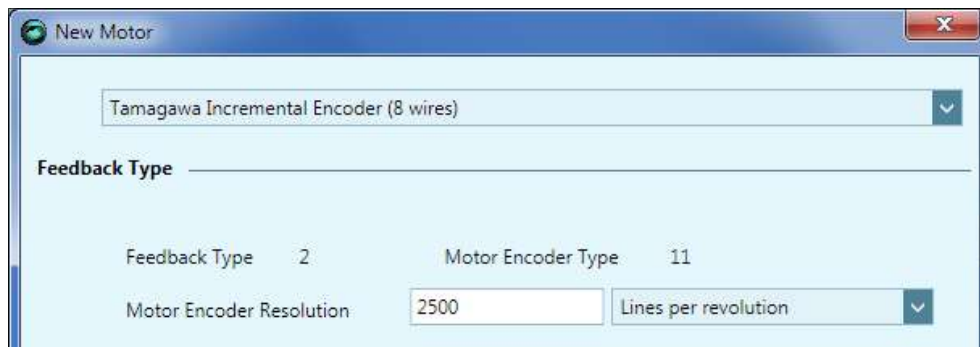
Rotor Inertia: 0.03    kg \* m<sup>2</sup> \* 10<sup>-3</sup>

<< Previous    Next >>

**Figure 7-7. Flexi SUITE – New Motor Definition**

Description	VarCom
MOTORTYPE	Rotary Motor / Linear Motor
MIPEAK	Motor Peak Current
MICONT	Motor Continuous Current
MSPEED	Motor Maximum Speed
ML	Motor Inductance
MR	Motor Resistance
MPOLES	Motor Poles
MKT	Torque Constant (Rotary Motor)
MJ	Rotor Inertia (Rotary Motor)
MKF	Torque Constant (Linear Motor)
MMASS	Mass of Motor Without Load (Linear Motor)
MPITCH	Motor Pitch (Linear Motor)

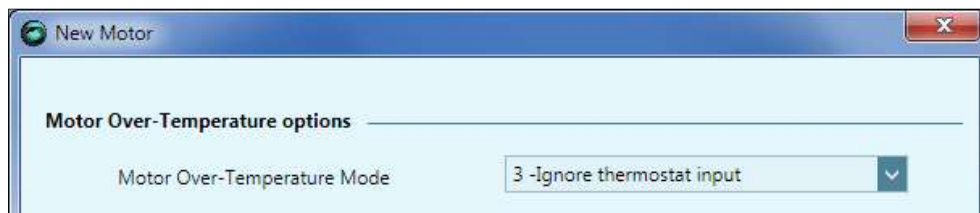
**Step 2 – Motor Feedback Selection**



**Figure 7-8. Flexi SUITE – New Motor - Feedback**

Description	VarCom
FEEDBACKTYPE	Feedback Type
MENCTYPE	Motor Encoder Type
MENCRES	Motor Encoder Resolution

**Step 3 – Thermal Protection Definition**



**Figure 7-9. Flexi SUITE – New Motor – Thermal Protection**

Description	VarCom
THERMODE	Motor Over-Temperature Mode

**Step 4 – Verify**



**Verify** enables the drive and moves the motor!

Do one of the following to complete the procedure, according to where the New Motor wizard was activated,

- If the New Motor wizard was activated from **Step 2 of the Motor Setup** wizard, press **Verify** to send parameters to the drive and test the motor configuration. Wait for the Motor Setup Successful message.

Parameters are not saved to the library when the wizard is activated from the Motor Setup.

- If the New Motor wizard was activated from the **Motor** screen, press these buttons in the following order:
  - a. **Save Library** to save the set of parameters to the database.
  - b. **Write to Drive** to send the parameters to the drive.
  - c. **Verify** to test the motor configuration.
  - d. Wait for the Motor Setup Successful message to appear.

**Motor**

---

**Select Motor from Library**

Family: User Motors User defined motors

Ver 1.5 UserLibrary

Model: Demo Motor

Define New Motor

---

**Motor**

Save Library
Load from Drive

Delete Model
Write to Drive

Copy to User Library

Name	Value	Units
Motor Name	Demo Motor	
Motor Type	0	
Motor Peak Current	15.000	A
Motor Continuous Current	5.000	A
Motor Maximum Speed	4500.000	rpm
Motor Inductance	4.200	mH
Motor Resistance	1.870	Ohm
Motor Poles	2	poles
Torque Constant	0.016	Nm/A
Rotor Inertia	0.030	Kgm2*10-3
Motor Encoder Resolution	2500	Lines per revolution
Feedback Type	2	
Motor Encoder Type	11	
Phase Find Mode	2	
Phase Find Current	0.848	A
Phase Find Duration	100	ms
Phase Find Gain	10.000	

---

**Verify**

Verify
Stop

Motor Setup Active  
Stage: 33/48

[Click for Details](#)

**Figure 7-10. Flexi SUITE – New Motor – Verify**

## 8 Operation

### 8.1 Drive Enable



**Caution!**

Enabling the drive might cause the motor to move.

The following elements provide visual indications of the drive's enabled or disabled status:

	<p>The <b>Enable Disable</b> button in the Flexi SUITE toolbar indicates the state of the drive.</p> <p>If lit, the drive is enabled (active). Power is being applied to the motor.</p> <p>If unlit, the drive is disabled.</p>
	<p>The decimal point (.) on the drive's 7-segment display indicates the drive's Enable/Disable state. If the point is displayed next to the OPMODE code, the drive is enabled.</p>

Three conditions are required for enabling the FLEXI PRO drive:

- No faults.
- Software Enable switch must be ON (SWEN=1)
- Remote Enable switch must be ON (REMOTE=1)

Use the Flexi SUITE **Enable & Faults** screen to view and control the conditions required for enabling the drive.














### 8.2 Operation Modes

The FLEXI PRO can work in a number of operation modes. Each operation mode has a primary control loop (current, velocity or position) and a source of the command being recognized (analog or serial input). Analog Velocity mode, for example, indicates that the primary control loop is velocity and the drive will respond to a  $\pm 10$  VDC analog command applied to the main analog input.

















OPMODE defines the operation mode.

The mode in effect is indicated on the 7-segment display by a steadily-lit single digit, as shown in the tables below.

**Table 8-1. Serial Communication – Operation Mode**

Display	VarCom	Description	Drive Enabled	Drive Disabled
.		Drive enabled		
0	OPMODE 0	Serial velocity control mode		
1	OPMODE 1	Analog velocity control mode		
2	OPMODE 2	Serial current control mode		
3	OPMODE 3	Analog current control mode		
4	OPMODE 4	Master/slave gearing control mode		
8	OPMODE 8	Position control mode		

**Table 8-2. CANopen Communication – Fieldbus Operation Modes**

Display	Description	Drive Enabled	Drive Disabled
0	No mode assigned.		
1	Profile position mode		
3	Profile velocity mode		
4	Profile torque mode		
6	Homing mode		
8	Cyclic synchronous position mode		
9	Cyclic synchronous velocity mode		
10	Cyclic synchronous torque mode <b>Note:</b> Digits 1 and 0 are displayed in succession		

## 8.3 Current Operation

### 8.3.1 Serial Current Operation Mode

In Serial Current mode ([OPMODE 2](#)), only the current loop is active, and the drive responds to instructions received via the USB or RS232 ports.

Other than tuning the current loop, no drive variables need to be set in order to operate the drive in this mode.

In the Flexi SUITE **Motion** task screen, select **Operation Mode 2 – Serial Current** to modify and test parameters.

### 8.3.2 Analog Current Operation Mode

When operating in Analog Current mode ([OPMODE 3](#)), only the current loop is active, and the drive responds to analog commands from the primary analog input, connected at pins 8 and 26 of the Controller I/F interface.

In the Flexi SUITE **Motion** task screen, select **Operation Mode 3 – Analog Current** to modify and test parameters.

### 8.3.3 Current Control Loop

**Note:** There is no need to manipulate values in the Current Loop screen, unless instructed to do so by Technical Support.

Current control loop tuning is derived from the motor properties and the bus voltage. The Flexi SUITE Motor Setup wizard tunes the current control loop.

## 8.4 Velocity Operation

### 8.4.1 Serial Velocity Operation Mode

In serial velocity mode ([OPMODE 0](#)), the drive's current and velocity loops are active, and the drive responds to instructions received via the USB or RS232 ports. The commanded velocity is subject to programmable acceleration and deceleration limits.

In the Flexi SUITE **Motion** task screen, select **Operation Mode 0 – Serial Velocity** to modify and test parameters.

### 8.4.2 Analog Velocity Operation Mode

When operating in Analog Velocity mode ([OPMODE 1](#)), the drive's current **and** velocity loops are active, and the drive responds to analog commands from the primary analog input, connected at pins 8 and 26 of the Controller I/F connector.

The commanded velocity is subject to a limit on the acceleration, defined by the variable ACC.

### 8.4.3 Velocity Control Loops

Refer to VarCom [VELCONTROLMODE](#).

- PI controller (uses KVP and KVI)

- PDFF controller(uses KVP, KVI, KVFR)
- Standard pole placement controller (uses MJ, MKT, BW, LMJR, TF )
- HD velocity loop with integrator (uses KNLD, KNLP)

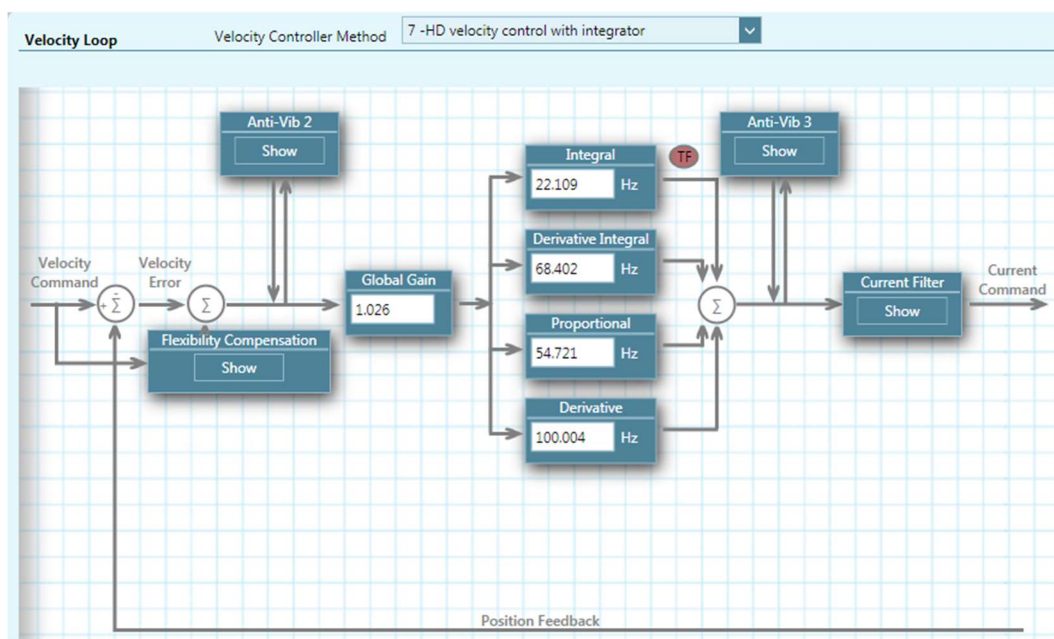
## HD Velocity Control with Integrator (Recommended)

Refer to VarCom [VELCONTROLMODE 7](#).

Before using the HD velocity controller, first execute the Flexi SUITE Autotuning wizard, and then manually adjust the tuning, if necessary.

You can then proceed to use the HD velocity controller.

VELCONTROLMODE 7 provides the advantages of the HD nonlinear controller for velocity control.



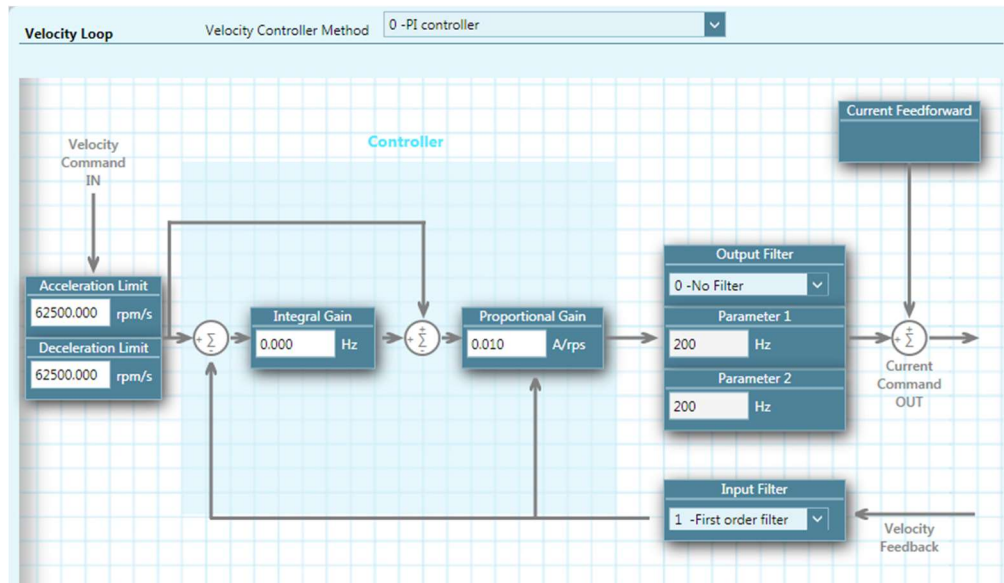
**Figure 8-1. Velocity Control – HD with Integrator**



## Proportional and Integral (PI) Controller

Refer to VarCom [VELCONTROLMODE 0](#).

The following figure shows a PI controller.



**Figure 8-2. Velocity Control – PI Controller**

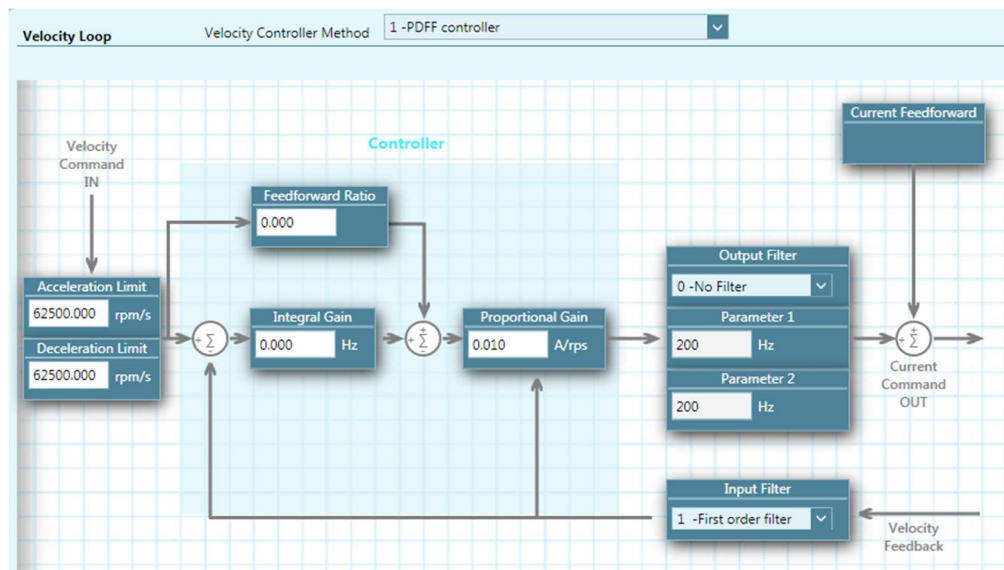
The PI controller is a unity feedback system with no pre-filter. The proportional gain (KVP) stabilizes the system. The integral gain (KVI) compensates for the steady state error.

The controller parameters KVP and KVI and KVFR are tuned by trial and error.

## Pseudo Derivative Feedback and Feedforward (PDFF) Controller

Refer to VarCom [VELCONTROLMODE 1](#).

The following figure shows a PDFF controller. Like the PI controller, it has an integral gain (KVI) and a proportional gain (KVP), with the addition of a feedforward, KVFR.



**Figure 8-3. Velocity Control – PDFF Controller**

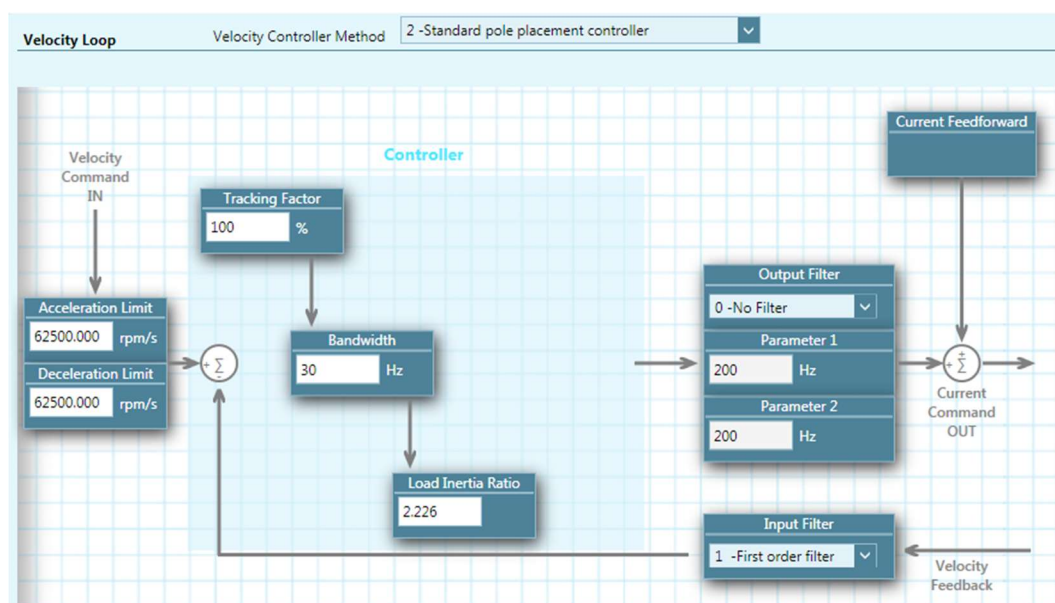
When an application requires maximum responsiveness, less integral gain is required, and KVFR can be set to a higher value. When an application requires maximum low-frequency stiffness, KVFR is set to a lower value, which allows much higher integral gain without inducing overshoot. This will also cause the system to be slower in responding to the command. A mid-range KVFR value is usually suitable for motion control applications.

PDFF is a generalized controller. The controller parameters KVP , KVI and KVFR are tuned by trial and error.

## Standard Pole Placement (PP) Controller

Refer to VarCom [VELCONTROLMODE 2](#).

For PP controller tuning, only two parameters are needed: load inertia ratio (LMJR) and closed-loop system bandwidth (BW).



**Figure 8-4. Velocity Control – Standard PP Controller**

For the controller design, it is not necessary to know the load inertia. The parameter can be easily tuned, as described in the following procedure.

Use the following procedure to manually tune the PP Velocity Controller.

### Procedure - Manual Tuning of the PP Velocity Controller

Manual tuning includes the initial steps of load inertia estimation, and the subsequent steps to design the optimum controller.

In Flexi SUITE, go to the **Terminal** screen or a Terminal tab, and execute the steps using standard ASCII protocol.

Alternately, use the Flexi SUITE **Scope** screen to execute and record motion, and evaluate and adjust the parameters.

1. Set the operation mode to serial velocity: **OPMODE 0**.
2. Set the velocity compensator to standard pole-placement: **VELCONTROMODE 2**.
3. Enable the drive: **EN**.

4. Set the desired bandwidth. It is recommended to begin with a low value (**10 Hz**), and gradually increase it.
5. Set the load inertia ratio to zero: **LMJR 0**.  
The load inertia value LMJR is expressed as a percentage of the rotor inertia.  
The range for LMJR is 0 to 10,000. It represents a range of load: rotor inertia ratios ranging from 0:1 to 100:1. For example, to set a 10:1 ratio between the load inertia and the motor inertia, use the command LMJR 1000. At this point the step response should have the maximum overshoot, but the control loop should be stable (low gains).
6. Activate the recording mechanism to record the velocity command, the current command, and the actual (feedback) velocity:  
**RECORD 1 1024 "VCMD ICMD V**
7. Jog the motor at a constant low speed: **J [value1]**  
For example, start with the command **J 150**
8. Activate the recording trigger: **RECTRIG VCMD [value2] 20 1**.  
*value2* should be greater than *value1* in the previous step; for example: RECTRIG VCMD 200 20 1.
9. Jog the motor at a value higher than specified in the RECTRIG command. This is actually the step command. The higher the step, the better the results. The step should not be less than 300 (rpm). For example: **J 500**.
10. The recording takes about half a second. After this period, reduce the motor speed.
11. Verify that the recording process is terminated: **RECDONE**
12. Display the recorded data by dumping to the serial port: **GET**
13. Analyze the results.  
If the current command is saturated (gets absolute values of ILIM) during the process, reduce the step or reduce the bandwidth, and return to Step 6.
14. Inspect the feedback velocity:
  - If there is an undershoot or oscillations, reduce **LMJR** to the mean value of the present LMJR and the last LMJR which had an overshoot, and return to step 6.
  - If there is an overshoot, increase LMJR by 100, and return to Step 6.
  - Repeat the process until the overshoot is reduced to a minimum (The estimated load inertia may be queried by LMJR.)

## 8.5 Position Operation

### 8.5.1 Serial Positioning Operation Mode

The FLEXI PRO has a dedicated mode of operation (**OPMODE 8**) for simple positioning applications over the serial port. Serial commands are transmitted from a host computer through the serial port. The command specifies the target position and the cruise velocity, while additional motion profile information (such as acceleration, deceleration and profile type) is set up using explicit variables.

In the Flexi SUITE **Motion** task screen, select **Operation Mode 8 – Positioning** to modify and test parameters.

VarCom	Description
ACC	Defines the acceleration.
DEC	Defines the deceleration.
PE	Position error (also called following error). PE is the absolute calculated difference between the values of PCMD and PFB. Read only.
PCMD	The position reference command. Read only.
PFB	The actual position according to the motor feedback. Read only.

## Incremental (Relative) Motion

Incremental, or relative, motion moves the motor relative to the current position. Relative motion is always in reference to the current position of the load (and motor shaft), and is useful in indexing applications, such as cut-to-length feeders and rotary tables.

The reference point is the parameter PFB, which is the actual position according to the motor feedback.

Movement can be in either direction, depending on the sign of the position value. For example, if the target position is one revolution, the motor will turn one revolution from the starting point.

VarCom	Description
MOVEINC	Command to execute an incremental position movement according to the acceleration settings in effect.

The value of PFB can be modified, or offset, using the parameter PFBOFFSET. This is useful for manual homing, or simply for testing incremental motion.

### Procedure – Setting the Current Position to 0

1. Disable the drive. (PFBOFFSET can be set only when the drive is disabled.)
2. Set PFBOFFSET to 0 (zero).
3. Read PFB
4. Set PFBOFFSET to the negative value of PFB

When using counts as the position units, PFBOFFSET can be set to an integer value only, even though the actual position, PFB, is displayed as a real number, with fractions of a count (as a result of internal interpolation being executed on the encoder signal).

## Absolute Motion

Absolute motion is always relative to an absolute reference point.

The reference point is the point at which PFB=0.

VarCom	Description
MOVEABS	Command to execute an absolute position movement according to the acceleration settings in effect.

## End of Motion

The following parameters are used to define and indicate the state of the motor at the end of motion.

VarCom	Description
PEMAX	The maximum position error allowed without producing a fault, in counts.
PEINPOS	The window of tolerance for declaring an "in position" state. The motor is considered to be <b>in position</b> when the value of PE (position error) is less than the value of PEINPOS (position-error tolerance). The motor is considered <b>settled</b> when PE (position error) has remained below PEINPOS for the time defined by PEINPOSTIME.
INPOS	Indicates Motor In Position state. Read only. When the motor is in position, INPOS=1, regardless of the state of the motion profile. As long as the motor is not in position, INPOS=0.
STOPPED	Indicates Motor Settled state. Read only. STOPPED=-1. Motion was interrupted. STOPPED=0. Motion profile in progress. STOPPED=1. Profile completed. STOPPED=2. Profile completed and INPOS=1.

### 8.5.2 Position Control Loop

The FLEXI PRO has two position control loop options – linear and HD (nonlinear).

The **Linear** position controller is a PID controller with feedforward, and with the option to limit the integral saturation (anti-windup).

The **HD** position controller is a proprietary algorithm that is designed to minimize position error during motion and to minimize settling time at the end of motion. This is the recommended controller. Refer to [Tuning](#).

## 8.6 Gearing Operation Mode

In Gearing operation mode, the drive's current, velocity and position loops are active, and the drive responds to incremental position pulses received from the controller or PLC.

In the Flexi SUITE **Motion** task screen, select **Operation Mode 4 – Position Gear Mode** to modify and test parameters.

The FLEXI PRO supports various types of gearing modes.

The parameter [GEARMODE](#) defines the gearing source and method.

VarCom	Description
GEARMODE 0	<p><b>Encoder Follower.</b> Signals are received on the Controller interface at pins 28 and 11 (Quadrature A), and pins 9 and 27 (Quadrature B). Alternately, if inputs 5 and 6 are set to INMODE 17 and 18, signals are received from Fast Inputs 5 and 6 on the Controller interface at pins 32 and 15.</p>
GEARMODE 1	<p><b>Pulse and Direction.</b> Signals are received on the Controller interface at pins 28 and 11 (Pulse), and pins 9 and 27 (Direction). Alternately, if inputs 5 and 6 are set to INMODE 17 and 18, signals are received from Fast Inputs 5 and 6 on the Controller interface at pins 32 and 15.</p>
GEARMODE 2	<p><b>Up/Down Counting.</b> Signals are received on the Controller interface at pins 28 and 11 (Up) and pins 9 and 27 (Down). Alternately, if inputs 5 and 6 are set to INMODE 17 and 18, signals are received from Fast Inputs 5 and 6 on the Controller interface at pins 32 and 15.</p>
GEARMODE 3	<p><b>Encoder follower (secondary encoder).</b> Signals are received on the Machine interface at pins 1 and 11 (Quadrature A) and pins 2 and 12 (Quadrature B).</p>
GEARMODE 4	<p><b>Pulse and direction (secondary encoder).</b> Signals are received on the Machine interface at pins 1 and 11 (Pulse), and pins 2 and 12 (Direction).</p>

Regardless of the gearing mode used, the input signal is subject to gearing calculations that allow you to set the ratio of input pulses to encoder counts. Gearing sets up a relationship between the number of input pulses (HWPEXT counts) and the position increments of the motor shaft (or actual motor position, PFB). The rate at which position increments of the motor shaft (motor speed) occur is determined by the gearing relationship and the line frequency of the pulse train. The gearing relationship is as follows:

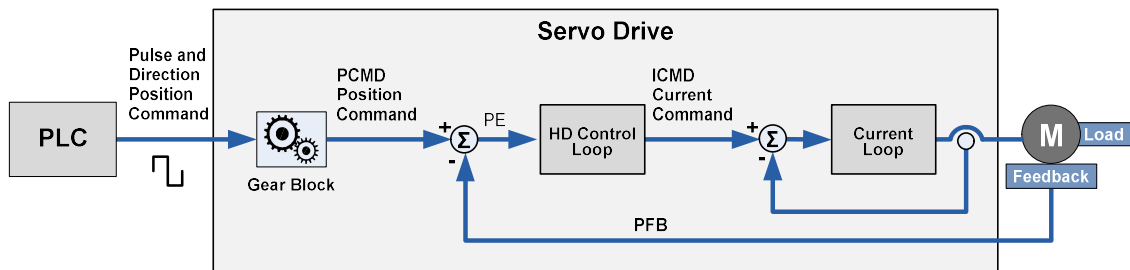
$$\frac{GEARIN}{GEAROUT} \times \frac{1}{XENCRES}$$

In addition to tuning the current, velocity and position loops, the following are some of the parameters used to configure and monitor the gearing.

VarCom	Description
GEAR	Activates the gearing function.
GEARIN	Numerator of the gearbox equation. The sign of the GEARIN determines the direction of rotation.
GEAROUT	Denominator of the gearbox equation.
XENCRES	Resolution of the external pulse source.
HWPEXT	The position measured by an external feedback device.

## 8.6.1 Pulse and Direction Mode

In Pulse and Direction position control, the drive is synchronized to a master input command signal in the form of a pulse train.



**Figure 8-5. Pulse and Direction Position Control**

The drive accepts an input pulse train in which the rising edge of each pulse increments (or decrements, depending on the direction) the external input position counter (HWPEXT) of the drive by one position count. This counter value is passed through a gearing block and becomes the position command for the motor.

The position command is compared to the actual motor position (PFB) to determine the position error (PE). The drive corrects the position error by incrementing the motor to the commanded position.

Gearing sets up a relationship between the number of input pulses (HWPEXT counts) and the position increments of the motor shaft (or actual motor position, PFB). The rate at which position increments of the motor shaft (motor speed) occur is determined by the gearing relationship and the line frequency of the pulse train.

In Pulse and Direction mode, if the absolute value of GEARIN is equal to GEAROUT, and if XENCRES is equal to  $4 \times \text{MENCRES}$  (that is, the motor encoder resolution after quadrature), then one pulse on the input is equivalent to one count of the motor feedback.

For example, assume that the motor encoder has a resolution of 2500 lines per revolution. Setting GEARIN=1, GEAROUT=1 and XENCRES=10000 will result in the motor making one revolution for every 10000 pulses (assuming the direction is fixed during this time).

**Note:** The drive's homing capabilities remain available in this configuration.

### Pulse and Direction Commands Using a Differential Signal

For differential signaling, the pulse and direction signals can be connected to either the Controller I/F interface (C2) or to the Machine I/F interface (C3).

If using the FLEXI PRO Controller I/F connector:

- The Pulse signals are received from the controller or PLC on pins 28 and 11.
- The Directions signals are received from the controller or PLC on pins 9 and 27.

If using the FLEXI PRO Machine I/F connector:

- The Pulse signals are received from the controller or PLC on pins 1 and 11
- The Direction signals are received from the controller or PLC on pins 2 and 12

The variable GEARMODE indicates to the drive where the signals are connected.

- GEARMODE 1 if connected through the Controller I/F connector (C2)
- GEARMODE 4 if connected through the Machine I/F connector (C3).

### Pulse and Direction Commands Using a Single-Ended Signal

The FLEXI PRO enables the connection of PLCs with a 24 VDC single-end signal to the drive. This type of signaling requires the use of the fast digital inputs on the FLEXI PRO Controller I/F connector (C2).

- The Pulse signal is connected to fast digital input 5 on pin 32.
- The Direction signal is connected to fast digital input 6 on pin 15.

Refer to Figure 8-6 below. The diagram shows how to connect the PLC to the FLEXI PRO Controller I/F (C2) connector.

- Connect the cable shield on the PLC side to any available shield connector.
- Connect the cable shield on the FLEXI PRO side to the shell of the 36-pin connector.

**Notes:** The 24 VDC power supply must be provided by the user.

Refer also to Table 3-10. I/O Specifications.

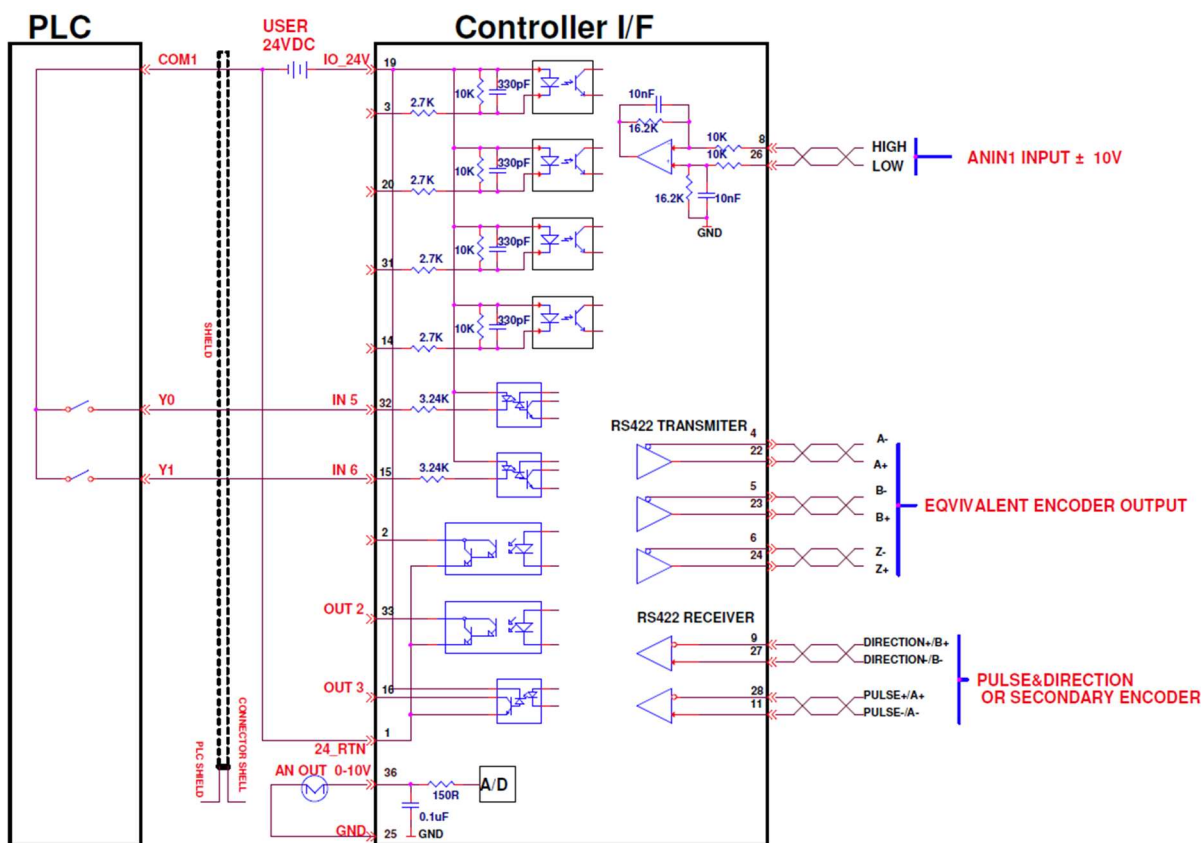


Figure 8-6. Wiring for Pulse and Direction Using Single-Ended Signal

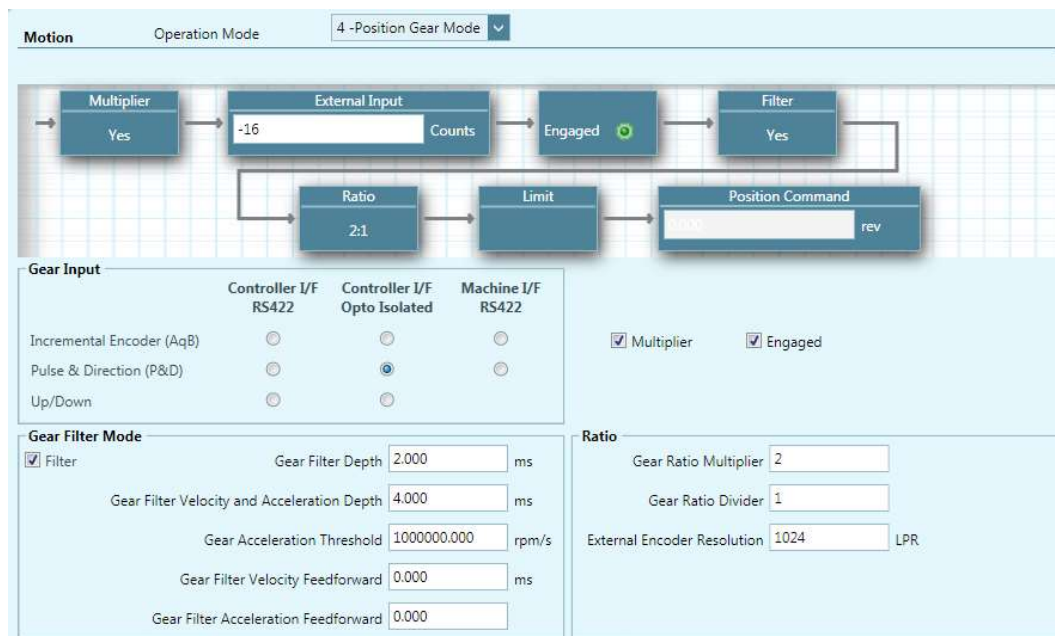
### Pulse and Direction Operation

For Pulse and Direction operation, the settings in the Flexi SUITE **Motion** screen are similar to those shown in the following figure. Actual values may differ. Refer to this figure when performing the following steps.



Using Flexi SUITE, the Pulse signal can be defined on digital input 5 (INMODE 5 17) and the Direction signal can be defined on digital input 6 (INMODE 6 18).

Selecting the option **Pulse & Direction (P&D)** and either **Controller I/F Opto-Isolated** or **Machine I/F Opto-Isolated** in the **Motion-Position Gear Mode** screen automatically sets the definitions for digital inputs 5 and 6.



**Figure 8-7. Motion Screen Settings for Pulse and Direction Commands Using a Single-Ended Signal**

### Step 1 – Setup and Tuning

1. Run the Flexi SUITE **Motor Setup Wizard**, and make sure motor setup is successfully completed.
2. Run the Flexi SUITE **Autotuning Wizard**, and make sure autotuning is successfully completed.

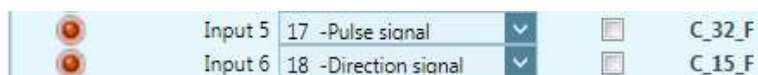
### Step 2 – Select Pulse and Direction

1. In Flexi SUITE, go to Tuning > **Motion** screen.
2. Select Operation Mode **4-Position Gear Mode**.
3. In the Gear Input pane:
  - **If using Differential Signal:**  
Select the option **Controller I/F RS422** and Pulse & Direction (P&D).
  - **If using Single-Ended Signal:**  
Select the option **Controller I/F Opto-Isolated** and Pulse & Direction (P&D). Alternately, select **Machine I/F Opto-Isolated** and Pulse & Direction (P&D). Either of these options automatically sets the definitions for digital inputs 5 and 6.

### Step 3 – Digital Inputs 5 and 6 Settings (Single-Ended Signal only)

1. Go to Drive Configuration > **Digital IOs** screen.
2. Make sure digital input 5 is set to **17-Pulse signal**.

3. Make sure digital input 6 is set to **18-Direction signal**.



**Figure 8-8. Digital Inputs for Pulse and Direction Signals**

#### Step 4 – Set Pulse and Direction Parameters

1. In the **Motion** screen, select **Multiplier**.

It is strongly recommended that you enable **Multiplier**. This internal FLEXI PRO feature is functional in pulse and direction operation, and improves the Pulse and Direction reading.

2. Make sure the Gear mode is **Engaged**.

3. In the Ratio pane, set the **External Encoder Resolution** and **Ratios**.

The relationship between the number of incoming pulses and the motor shaft movement is determined by the External Encoder Resolution, and the Gear Ratio Multiplier and Divider (GEARI/GEARO).

**For example:** A PLC controller is programmed to provide 1024 line pulses as an input command to a FLEXI PRO system in order to make the motor rotate two revolutions. The settings are therefore:

External Encoder Resolution = 1024

Gear Ratio Multiplier = 2

Gear Ratio Divider = 1

### 8.6.2 Master/Slave – Encoder Follower

In Master/Slave mode, the drive follows a quadrature encoder signal generated by a master device. The direction of motion is governed by the phase of the quadrature signals (A-lead-B or B-lead-A).

The master device can be, for example, a handwheel, a machine master encoder that is connected to the main camshaft, or the equivalent encoder output of another servo drive.

If the master device is a handwheel or a master encoder, then setting XENCRES equal to the resolution of the encoder (before quadrature) and setting the gear ratio to 1 will result in the motor making one revolution for each revolution on the input.

As an example, assume the handwheel resolution is 120 lines per revolution (that is, 480 counts after quadrature). Setting GEARIN=1, GEAROUT=1 and XENCRES=120 will result in one motor revolution for each turn of the handwheel.

The quadrature signals can be connected to either the Controller I/F connector or to the Machine I/F connector. The GEARMODE variable indicates to the drive where the signals are connected to.

**Note:** The Controller I/F connector cannot supply voltage to the handwheel or the machine master encoder. Only the Machine I/F connector can supply this voltage (pins 4 and 14 on connector C3).

- Set GEARMODE to 0 to indicate to the drive that the signals are received on the Pulse and Direction inputs on the Controller I/F connector (C2) at pins 28 and 11 (Quadrature A), and pins 9 and 27 (Quadrature B).

- Set GEARMODE to 3 to indicate to the drive that the signals are received on the Secondary Encoder inputs on the Machine I/F connector (C3) at pins 1 and 11 (Quadrature A) and pins 2 and 12 (Quadrature B).

### 8.6.3 Up/Down Counting

In an up/down counting system, pulses on one signal increment the motor position while pulses on the other signal decrement the motor position. The signals must be connected to the Controller I/F connector.

When the pulse signal is applied to the A channel, the external position counter (PEXT) increments and rotates the motor in a positive direction.

The pulse signal applied to the B channel decrements the external position counter (PEXT) and rotates the motor in a negative direction.

The line frequency and the gearing relationship determine the speed and amount of the shaft movement.

- Set GEARMODE to 2 to indicate to the drive that the signals received on the Pulse and Direction inputs on the Controller I/F connector (C2) at pins 28 and 11 (Up) and pins 9 and 27 (Down).

In the Flexi SUITE **Motion** task screen, select **Operation Mode 1 – Analog Velocity** to modify and test parameters.

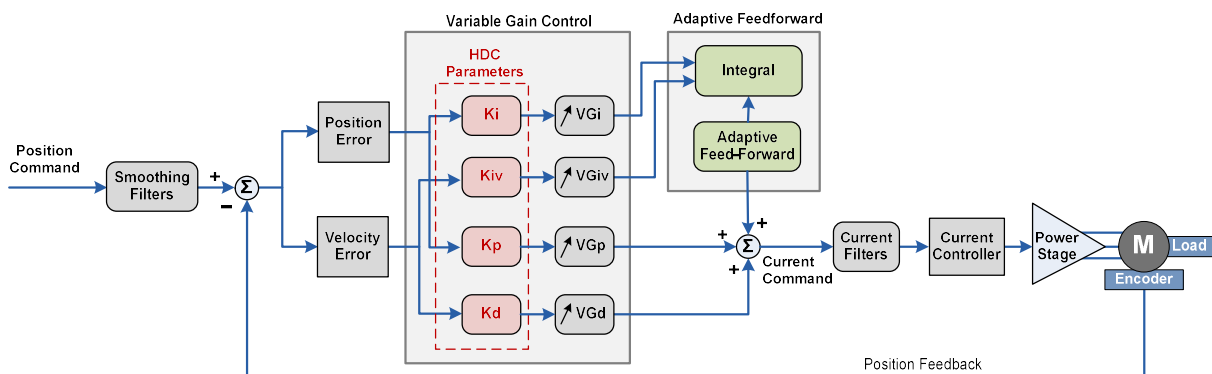


# 9 Tuning

## 9.1 FLEXI PRO HD Controller

The FLEXI PRO has two user-selectable position control loops – linear and HD (nonlinear).

The HD control loop is a proprietary algorithm that is designed to minimize position error during motion and to minimize settling time at the end of motion.



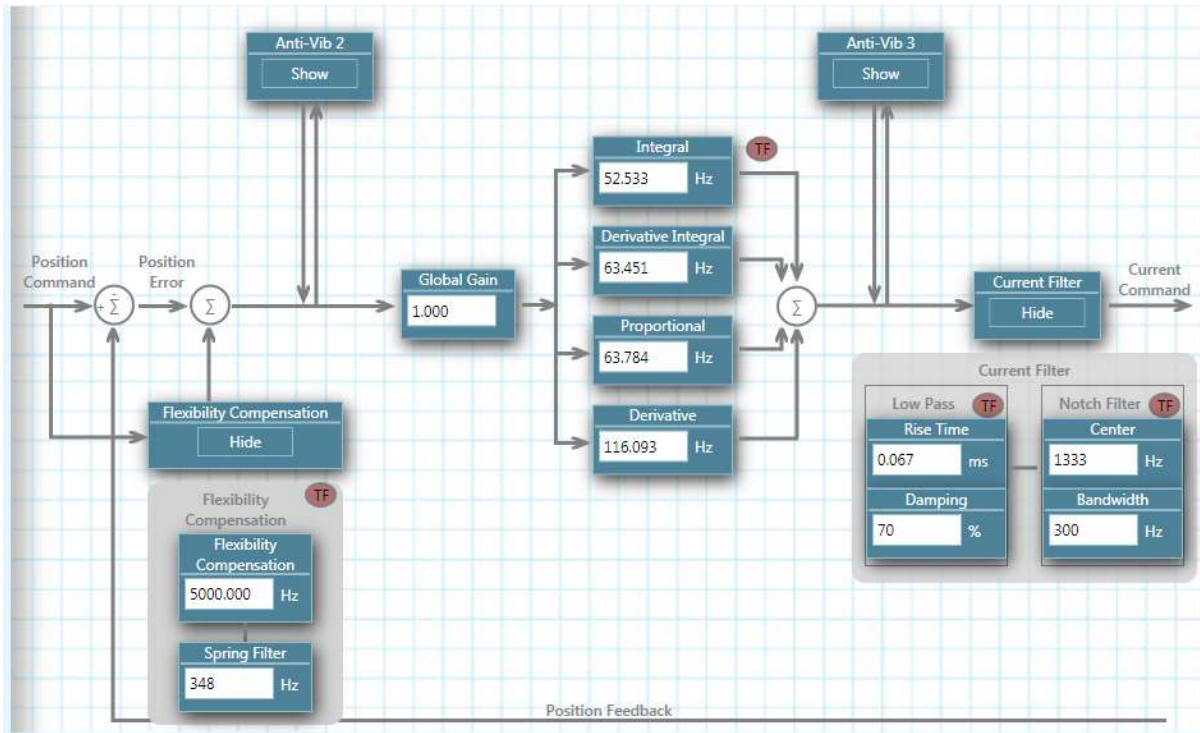
**Figure 9-1. FLEXI PRO HD Controller**

The HD algorithm uses a parallel configuration in which all branches are on the same level and executed during the same sampling period. On each branch a variable gain is introduced and automatically optimized for high gain and stability.

The HD controller also includes an adaptive feedforward function that is applied at the end of movement in order to achieve a zero or minimum settling time.

Furthermore, the HD controller provides low pass, notch and other filters to handle flexible and resonant systems.

The Flexi SUITE Position Control Loop screen provides access to the HD control loop parameters that can be modified by users.



**Figure 9-2. FLEXI PRO HD Control Loop**

## 9.2 FLEXI PRO HD Controller Autotuning



### Caution!

Tuning is potentially dangerous. Before starting any tuning routines, make sure no one is within the motion envelope, and the emergency button is within your reach.

Autotuning is performed on the FLEXI PRO's HD control loop. There is no autotuning procedure for the linear control loop.

The HD control loop parameters are initially set using the Autotuning wizard. Drive tuning performed by the wizards is usually sufficient. However, you may need to tune the control parameters manually to optimize them for particular applications. The parameters can be viewed and modified in the Flexi SUITE Position Loop HD Controller screen.

Automatic and manual tuning use similar methods. During autotuning, the quality of the movement is measured and evaluated by the drive or the software. During manual tuning, the quality of movement is evaluated by the user. In both cases, the servo control parameters are modified progressively and the value that achieves the best performance is selected.

The Autotuning wizard can also be used to optimize drive parameters to produce the most effective motion for a particular task or application.

## 9.3 PC-Based Autotuning

As of firmware version 1.40.0, autotuning may be either drive-based or PC-based.

Flexi SUITE will activate the wizard for PC-based autotuning if an electronic motor nameplate is not detected at power-up.

**Note:** The PC-based Autotuning wizard overrides the user's unit settings and works in the following units:

- Position: counts
- Velocity: rpm/s for rotary motors, and mm/s for linear motors
- Acceleration/deceleration: rpm/s<sup>2</sup> for rotary motors, mm/s<sup>2</sup> for linear motors

### Step 1 – LMJR Estimation

**Autotuning**

**Step 1: Load to Motor Inertia Ratio Estimation**

1. Do either of the following:
  - Let the drive estimate load inertia.
  - Enter a specific value for load inertia.
2. Modify the motion distance if needed
3. Press Start.

**Caution: Start enables the drive and moves the motor!**

**Estimation Mode:**

Move and estimate load inertia

Use known load inertia:  kg\*m<sup>2</sup>\*10<sup>-3</sup>

Motion distance (0.2 - 3):  rev

**Start Load Estimation**

Load Gain Test Save BACK Step 1 of 4 NEXT

**Figure 9-3. Autotuning Wizard – LMJR Estimation**

1. For automatic estimation, select **Move and estimate load inertia**.  
or  
If you know the inertia of the load connected to the motor, select **Use known load inertia**, and enter the value.
2. Optionally, modify the number of motor revolutions to be used as the motion distance during the load estimation.
3. Click **Start Load Estimation**.

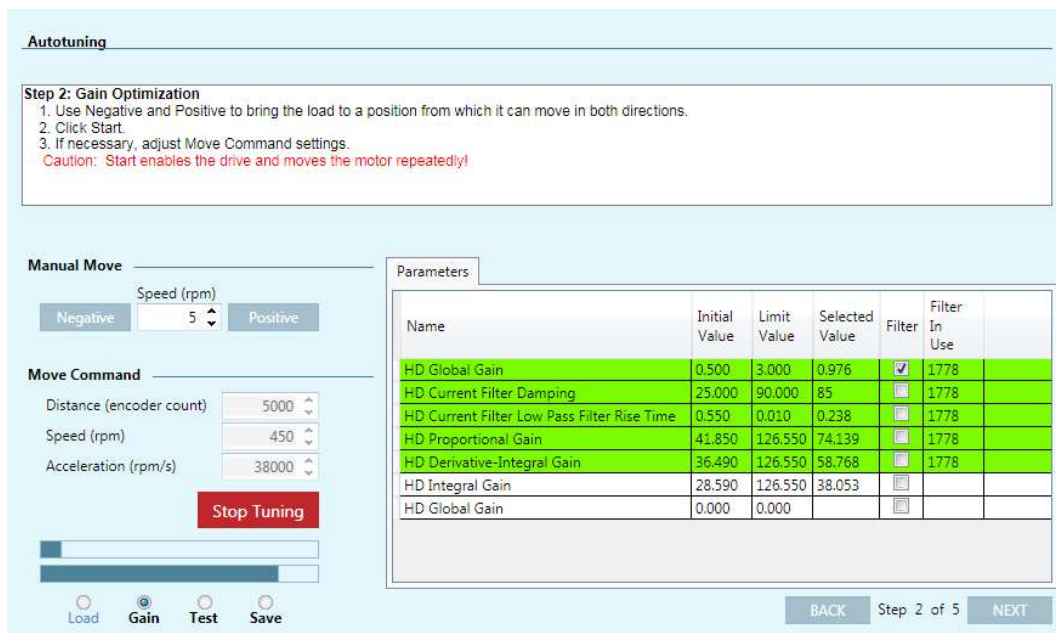


**Start** enables the drive and moves the motor!

Flexi SUITE estimates the load currently on the motor, and displays the results.

4. Click **OK** to send the calculated parameters to the drive.
5. Click **Next** to continue.

### Step 2 – Gain Optimization



**Figure 9-4. Autotuning Wizard – Gain Optimization**

1. The displayed **Move Command** values are recommended values; they have been determined according to the motor you defined in the setup. Use the **Negative** and **Positive** buttons to bring the load to a position at which the motor can safely make a full rotation in each direction.
2. If necessary, adjust the Manual Move **Speed** setting.
3. Click **Start**.



**Start** enables the drive and moves the motor repeatedly!

The motor moves back and forth continuously, while Flexi SUITE tests values at intervals throughout the range for each of the control loop parameters. Once it achieves the best result, it displays the optimal value in the parameter table.

The top bar shows the progress of the parameter currently being tested.

The lower bar shows the progress of the entire process.

4. If necessary, adjust the **Move Command** settings, and click **Start** to repeat the test.



### Step 3 – Test Quality of Motion



**Figure 9-5. Autotuning Wizard – Test Quality of Motion**

1. Click **Move and Plot** to send a Move command to the drive and plot the step response.



**Move and Plot** enables the drive and moves the motor!

2. A plot appears. The graph shows the velocity command generated by the point-to-point position profile (PTPVCMD), and the position error (PE).

The wizard also displays the **Settling Time** and the **Position Error Window** values calculated by the system.

**Note:** The velocity and the position error graphs are scaled so that both fit into the frame. The Y-axis is marked in units of position error (counts).

The screen includes three buttons that let you examine the graph more closely, and another button for exporting results to a spreadsheet. The functions are also provided in the Flexi SUITE Scope screen.

3. Optionally, modify the motion settings and/or the gain setting, and repeat the test under different conditions:
  - Target Position
  - Cruise Velocity
  - Acceleration (and Deceleration)
  - HD Global Gain (KNLUSERGAIN); this is the global gain parameter for the HD (nonlinear position) control loop. A higher gain value results in stiffer control, and a lower value results in softer control.

## Step 4 – Save

Do all of the following:

- **Save to non-volatile drive** memory to save the parameters from the drive's RAM to the drive's permanent memory.
- **Save to backup file** to save the parameters in drive RAM to a backup file on the computer. The parameters are saved in a text file with either TXT or SSV extension. The text file can be edited using Notepad or any other text editor.
- **Generate Report** to create a record of system settings that can be sent to Technical Support should the need arise.

It is recommended that you create a report whenever you complete configuration of your application, even when the system is functioning properly.

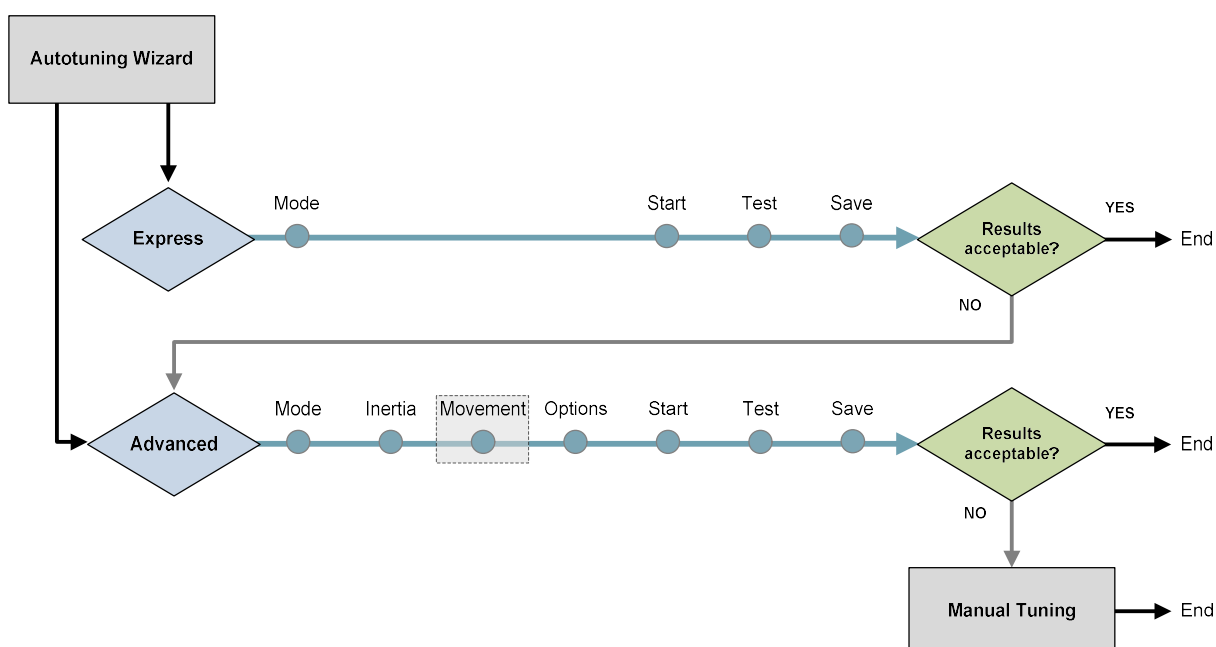
## 9.4 Drive-Based Autotuning

As of firmware version 1.40.0, autotuning may be either drive-based or PC-based.

### 9.4.1 Drive-Based Autotuning – Overview

Flexi SUITE will activate the wizard for Drive-based Autotuning if an electronic motor nameplate with a servo parameter bundle (e.g., PRO2 motor with sensAR magnetic encoder) is detected at power-up. In addition, the Drive-based Autotuning wizard will be activated if the software is operating offline.

The wizard has two possible routines: **Express** and **Advanced**.



**Figure 9-6. Autotuning Wizard for Drive for Motor with Load**

## 9.4.2 Drive-Based Autotuning – Express

The **Express** autotuning procedure requires no user input except to activate each step.

**Express** Autotuning consists of the following steps:

1. Set the motion generator: **Drive**  
Optional: Manually move the axis to the start position.
2. Run Autotuning.
3. Test the result.
4. Save the parameters.

For details on each of the steps, refer to the section [Drive-Based Autotuning – Advanced](#).

**Table 9-1. Steps in Autotuning Process**

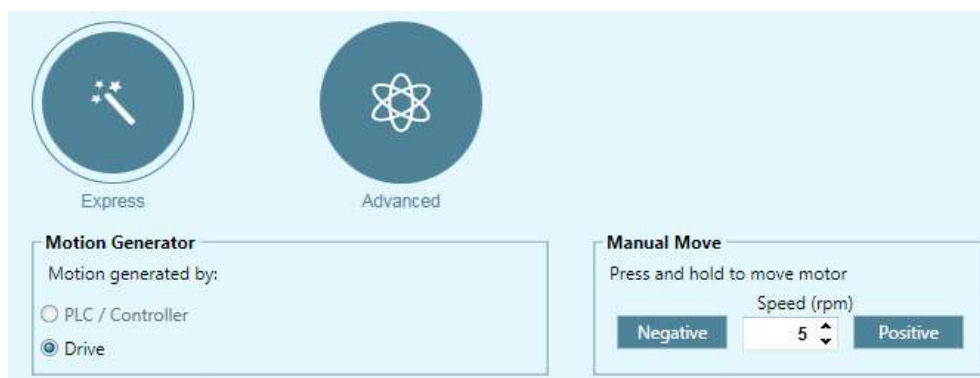
	<b>Express</b>	<b>Advanced</b>
<b>Mode</b>	x	x
Inertia		x
Movement		x
Options		x
<b>Start</b>	x	x
<b>Test</b>	x	x
<b>Save</b>	x	x

## 9.4.3 Drive-Based Autotuning – Advanced

The **Advanced** autotuning procedure consists of the following steps:

1. Set the motion generator: **Drive**  
Optional: Manually move the axis to the start position (available when drive generates the motion).
2. Load/motor inertia ratio estimation.
3. Set motion profile.
4. Set options for parameter optimization.
5. Run autotuning.
6. Test the result.
7. Save the parameters.

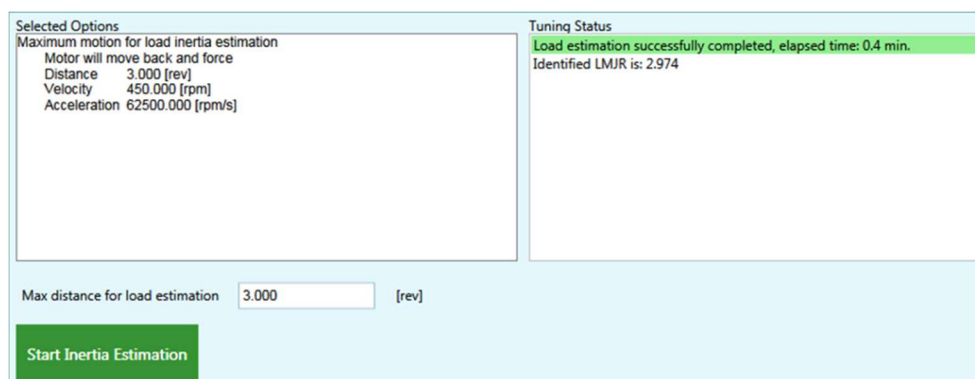
## Step 1 – Tuning Mode



**Figure 9-7. Autotuning – Tuning Mode**

1. Select the Tuning Mode: **Advanced** (or **Express**).
2. Set the motion generator: **Drive**
3. Motion testing normally starts at the midpoint of the movement stroke. If a different start position is required by the application, use **Manual Move**.  
Use the **Negative** and **Positive** buttons to bring the load to a position at which the motor can safely make three rotations in each direction. Press and hold the buttons for continuous motion.
4. Click **Next** to continue.

## Step 2 – Load/Motor Inertia Ratio



**Figure 9-8. Autotuning – Inertia Ratio Estimation**

Normally, you should allow the servo drive to estimate the load/motor inertia ratio (**LMJR**).

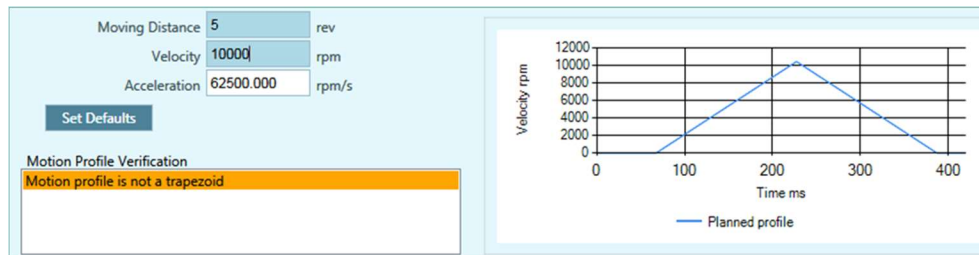
You may need to set the moment of inertia manually (see [Step 4 – Options: LMJR Values](#)) to achieve better performance, in instances such as:

- If the load/motor ratio is very big.
- If you know the exact value of the inertia of the load connected to the motor.
- If the inertia of the load varies.
- If using a multi-axis robot.

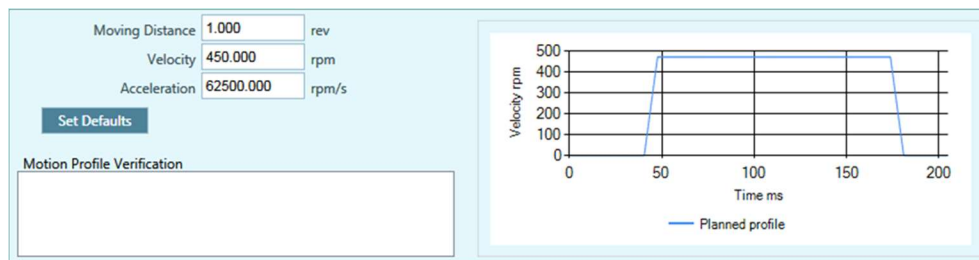
Click **Next** to continue.

### Step 3 – Movement

**Note:** Movement step is available only when the drive is the motion generator.



**Figure 9-9. Autotuning – Motion Profile. Not Suitable**



**Figure 9-10. Autotuning – Motion Profile. Suitable**

Autotuning must be performed using a motion profile that replicates the actual mechanical characteristics of the movement to be performed in the application.

Use values that produce a trapezoidal profile on the graph. The software will indicate whether or not the profile is suitable for the autotuning procedure.

- Highlighted orange: profile is possible, but not recommended
- Highlighted red: profile cannot be used.

Click **Next** to continue.

### Step 4 – Options: Vibration Suppression

Select **Vibration Suppression** for automatic tuning of the parameter sets Antivibration2 and Antivibration3.

Clear this option if you want to set vibration suppression parameters manually, or if the application does not require vibration suppression.

Enhanced anti-vibration will have the following effect on performance:

- Will damp oscillations, thereby improving settling time.
- May allow a higher gain of the HD loop.
- May increase the position error of the motor, but reduce the position error and oscillation of the end effector.

Click **Next** to continue.

### Step 4 – Options: Vertical Application

*Not yet supported.*

### Step 4 – Options: Acceleration Feedforward

Select this option to reduce tracking error during motion.

If selected, the autotuning sets the value of parameter **KNLFARC**.

Clear this option if overshoot is too large.

Click **Next** to continue.

#### Step 4 – Options: Smoothing

*Not yet supported.*

#### Step 4 – Options: LMJR Values

**Figure 9-11. Autotuning – LMJR Values**

Typically the autotuning can use the LMJR value calculated in Step 2.

For some systems you may need to set LMJR manually. In such instances, clear the option to use the Estimated LMJR value, and enter inertia values.

Refer to [Step 2 – Load/Motor Inertia Ratio](#).

#### Step 5 – Start

1. Press **Start Tuning** to begin the autotuning process.



**Start** enables the drive and moves the motor repeatedly!

**Figure 9-12. Autotuning – Start**

The motor moves back and forth continuously while testing values at intervals throughout the range for each of the control loop parameters.

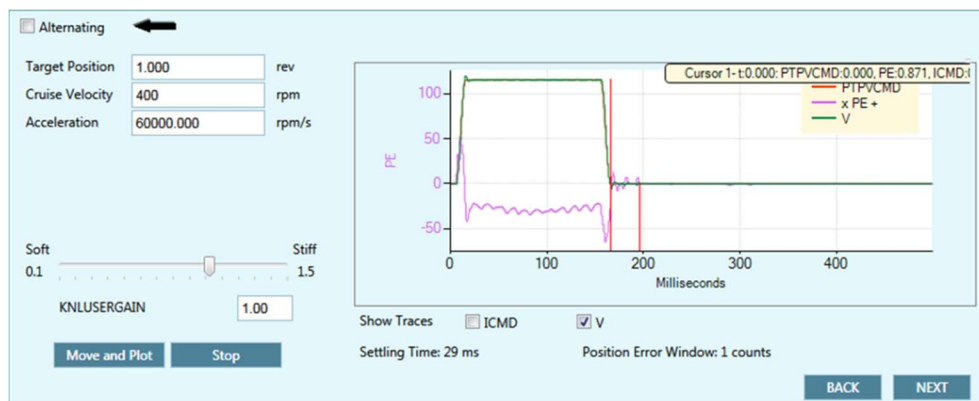
When the autotuning is completed, press **Modified Parameters** to view the new settings.

Name	Before	After	Description
KNLD	80.000	87.703	HD Derivative Gain
KNLI	10.000	19.014	HD Integral Gain
KNLIV	40.000	28.671	HD Derivative-Integral Gain
KNLP	30.000	36.699	HD Proportional Gain
KNLUSERGAIN	0.500	1.000	HD Global Gain
KNLUSERVCMDCMDGAIN	1.000	0.000	HD Adaptive VCMD Gain
NLAFFLPFHZ	7000	5000	HD Spring Filter
NLANTIVIBSHARP2	0.500	0.050	HD AV 2 Filter Sharpness
NLANTIVIBSHARP3	0.200	0.035	HD AV 3 Filter Sharpness
NLFILTDAMPING	60	10	HD Current Filter Damping
NLFILT1	3.000	0.100	HD Current Filt Low Pass Rise Time
NLNOTCHBW	0	300	HD Current Filter Notch Bandwidth
NLNOTCHCENTER	100	1333	HD Current Filter Notch Center
GEARFILT1	2.000	1.375	Gear Filter Depth
GEARFILT2	4.000	2.000	Gear Filter Vel and Acc Depth
LMJR	1.000	0.080	Load to Motor Inertia Ratio
MOVESMOOTHAVG	4.000	5.000	Position Command Moving Avg Filter
MOVESMOOTHLPFHZ	5000	87	Position Command Move LoPass Filter

**Figure 9-13. Autotuning – Modified Parameters**

Click **Next** to continue.

## Step 6 – Test



**Figure 9-14. Autotuning – Test**

1. Press **Move and Plot** to send a current command to the drive and plot the response.



**Move and Plot** enables the drive and moves the motor!

The resulting graph shows the position command profile in velocity units (PTPVCMD), and the position error (PE). Optionally, it can also display the velocity of the motor measured by the feedback device (V) and/or the current command (ICMD).

The wizard also displays the **Settling Time** and the **Position Error Window** values calculated by the system.

**Note:** The velocity and the position error graphs are scaled so that both fit into the frame. The Y-axis is marked in units of position error (counts).

2. If necessary, adjust the global gain parameter (KNLUSERGAIN):
  - A higher gain value produces a stiffer response

- A lower value results in a smoother response

Click **Next** to continue.

### Step 7 – Save



**Figure 9-15. Autotuning – Save**

When Autotuning is completed, do **all** of the following:

- Click **Save to Drive** to save the parameters in drive RAM to the drive’s non-volatile memory.
- Click **Save to File** to save the parameters in drive RAM to a backup file on the computer. The parameters are saved in a text file with either TXT or SSV extension. The text file can be edited using Notepad or any other text editor.
- Click **Generate Report** to create a record of system settings that can be used for future reference and/or sent to Technical Support should the need arise.

It is recommended that you create a report whenever you complete configuration of your application, even when the system is functioning properly.

## 9.5 Autotuning Parameters Summary

The following table lists the parameters that may be optimized and set during the Autotuning procedure.

Not all parameters are modified during the process. The final values of the parameters are determined by the specific options selected by user in the autotuning wizard.

√ Autotuning optimizes the parameter value

Y/N Autotuning sets the parameter, or user can set the value manually

**Table 9-2. Parameters Set During the Autotuning Process**

Function	Description	Parameter	Express	Advanced
<b>Gearing Filters</b>	Automatically optimized during the Autotuning process.	GEARFILTMODE	√	√
		GEARFILTT1	√	√
	Applicable for Position Gearing operation mode. The gearing filter interpolates the pulse and direction command.	GEARFILTT2	√	√
		GEARFILTVELFF	√	√
		GEARFILTAFF	√	√
<b>Move Smoothing Filter</b>	Use Autotuning to optimize parameters for smoothing the input profile command. Do not use Autotuning if the	MOVESMOOTHSRC	√	Y/N
		MOVESMOOTHMODE	√	Y/N
		MOVESMOOTHLPFHZ	√	Y/N



Function	Description	Parameter	Express	Advanced
	application is multi-axis and smoothing must be the same for all axes. Instead, use MOVESMOOTHAVG with a value between 1-15 ms.	MOVESMOOTHAVG	√	Y/N
HD Control Loop	Automatically optimized during the Autotuning process.	NLPEAFF	√	√
		NLAFFLPFHZ	√	√
		KNLD	√	√
		KNLI	√	√
		KNLIV	√	√
		KNLP	√	√
Current Control <b>Notch Filters</b>	<i>HD control loop parameters.</i>	NLNOTCHBW	√	√
		NLNOTCHCENTER	√	√
		NLNOTCH2BW	√	√
		NLNOTCH2CENTER	√	√
Current Control <b>Low Pass Filter</b>	<i>HD control loop parameters.</i>	NLFILT1	√	√
		NLFILTDAMPING	√	√
Acceleration Feedforward	<i>HD control loop parameter.</i> Use Autotuning to optimize parameters for achieving minimal tracking error during motion.  Do not use Autotuning if overshoot is too large.	KNLAFRC	√	Y/N
Global Gain	<i>HD control loop parameter.</i> Can be modified at <b>Test</b> stage of Autotuning process.	KNLUSERGAIN	Y/N	Y/N
<b>Anti-Vibration Filters</b>	Use Autotuning to optimize parameters for suppressing vibration.  Do not use Autotuning if you want to set vibration suppression parameters manually, or if the application does not require vibration suppression.	NLANTIVIBGAIN2		Y/N
		NLANTIVIBSHARP2		Y/N
		NLANTIVIBHZ2		Y/N
		NLANTIVIBGAIN3		Y/N
		NLANTIVIBSHARP3		Y/N
		NLANTIVIBHZ3		Y/N
Moment of Inertia	Use Autotuning to determine the load's moment of inertia.  Do not use Autotuning if the moment of inertia of the load varies (e.g., a multi-axis robot), or if you know the exact inertia. You can enter a value for either Load Inertia or Load Inertia Ratio; the software sets the other parameter accordingly.	LMJR	√	Y/N
Vertical Application	Use Autotuning to compensate for the effect of gravity when axis motion is vertical.  Do not use Autotuning if axis motion is balanced (non-vertical) in both directions.	IGRAV		Y/N

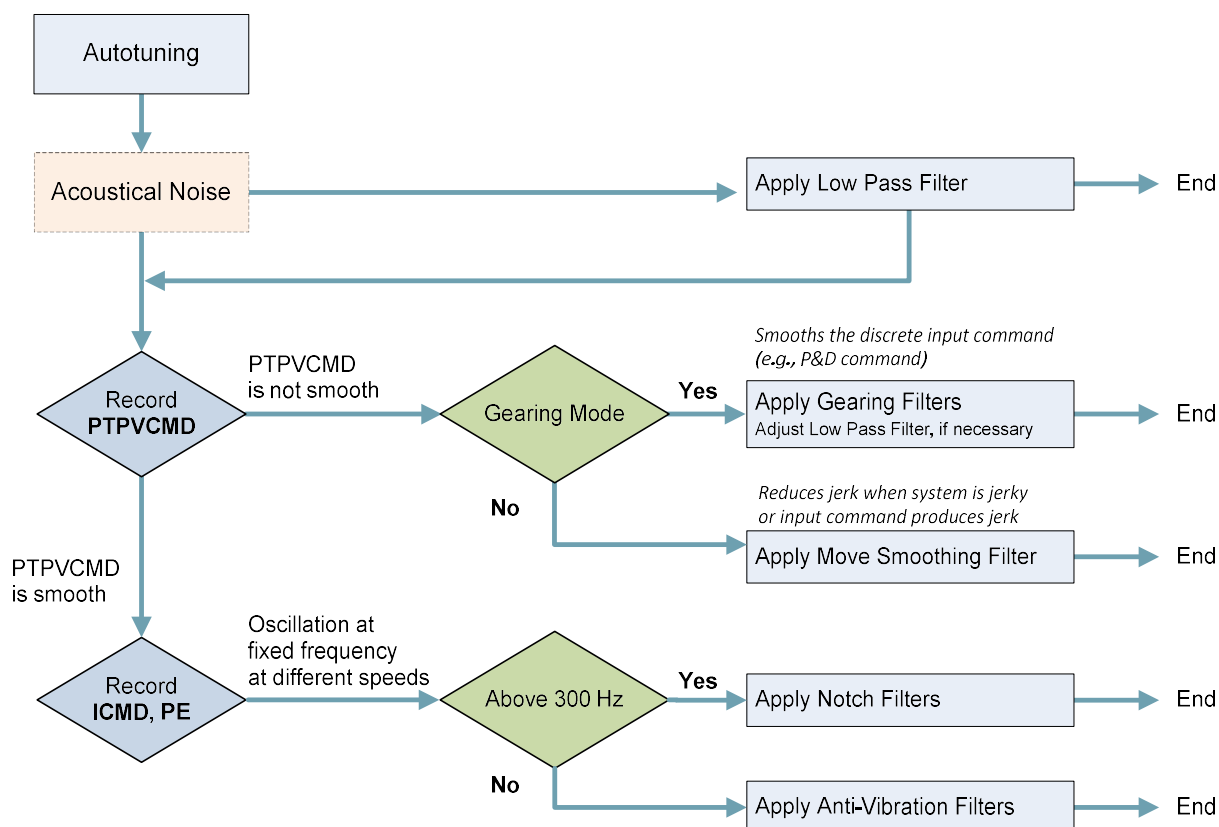
## 9.6 Recording and Evaluating Performance

### 9.6.1 Diagnostics

After autotuning has been completed, the system may display behavior that is less than optimal, such as:

- Servo motor is audibly noisy.
- Servo motor is very hot.
- Performance is not consistent.
- Foldback occurs; that is, the motor demands a level of current that drive cannot handle continuously.
- Jerk in system.
- Jerky movements.
- Excessive overshoot results in hitting application mechanical limits.

The following diagram outlines the procedures for diagnosing system behavior and applying filters to improve performance.



**Figure 9-16. Performance Diagnostics**

The FLEXI PRO recording function is used for performance verification, tuning and debugging. Flexi SUITE provides a full-featured graphic interface for recording, plotting and measuring data. Refer to the Flexi SUITE Reference Manual for details.

To improve or change performance of the FLEXI PRO system, refer to the Performance Diagnostics diagram, and manually modify and evaluate the parameters.

### Procedure – Modifying and Testing a Parameter

After each modification of a parameter, do the following:

1. Make sure Operation Mode is **8-Position**.
2. Execute a back/forth motion, and record **PE**, **ICMD** and **PTPVCMD**
3. Use the Flexi SUITE **Scope** screen to plot and evaluate the recorded values.
4. Check the **settling time of PE**.

## 9.6.2 Recording Data in Flexi SUITE

### Procedure – Recording Data in Flexi SUITE – Example (MT-6CC401C Motor)

1. In the Flexi SUITE **Scope** screen, select the **Motion** tab.
  - Make sure Operation Mode is **8-Position**.
  - Set the value of the **Target Position** to **20,000** counts.
  - Set the values of the motion parameters to produce a movement at 50% of the motor's maximum speed, and 75% of the maximum acceleration required by the application. Thus, in this example:

Maximum speed (**Cruise Velocity**) is set to 1000

**Acceleration** (and **Deceleration**) is set to 50,000

- If you need a back and forth motion, select the option **Alternating**.

The aim is to achieve a motion profile that has substantial durations for the acceleration, plateau, and deceleration phases.

2. In the **Recorder Setup** panel, select the following **Record Variables**:
  - **PTPVCMD** (Position command velocity)
  - **ICMD** (Current command)
  - **PE** (Position error). Also enter a trace scaling factor of **50** for the PE variable.
3. In the **Recorder Setup** panel, enter the sampling values and trigger variable:
  - Samples: **1000**
  - Time Interval: **16**
  - Trigger: **IMM**

Make sure the drive is enabled, and then click the **Move Record and Plot** button in the Scope toolbar.



Note that the trace of the Position Error variable shown here is scaled by a factor of 50.

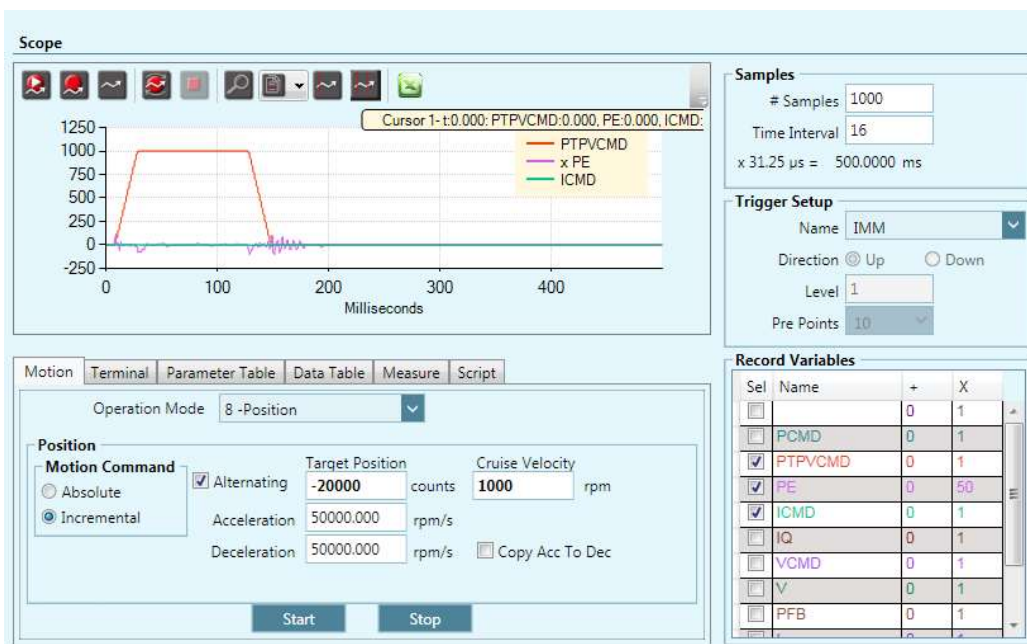


Figure 9-17. Motion Obtained with Default Parameter Values

4. Select the **Parameter Table** tab.

The screenshot shows the "Parameter Table" tab in the software. It contains a table with the following data:

Command	Value	Unit
HD Global Gain	1.000	
HD Derivative Gain	177.129	Hz
HD Proportional Gain	69.100	Hz
HD Derivative-Integral Gain	79.109	Hz
HD Integral Gain	31.477	Hz
HD Flexibility Compensation	5000.000	Hz
HD Spring Filter	5000	Hz
HD Maximum Adaptive Gain	2.763	
HD Current Filter Damping	15	%
HD Current Filter Low Pass Filter Rise Time	0.404	ms

Figure 9-18. Example of Parameters

Parameter KNLUSERGAIN (HD Global Gain) is set to 1.000 during autotuning. For additional, manual tuning, you can often begin with this setting. If the gain is too high – as evidenced by vibrations and noise – decreasing the value of KNLUSERGAIN can help achieve a smoother movement.

5. View position error and settling time  
Right-click in the recording chart pane, and select **Show Settling Time**.

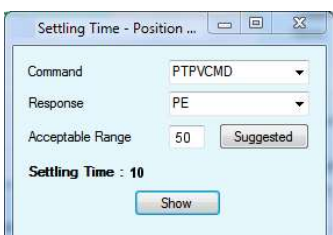


Figure 9-19. Position Error (counts) and Setting Time (ms)

The acceptable range of the response (position error) is the movement (in counts) at the endpoint.

$$\text{Acceptable range: } \frac{2 \times \pi \times \text{length}}{\text{resolution} \times \text{gear}}$$

**Example:**

Mechanical dimension (joint length) = 0.5 m

Motor resolution: 1 rev = 17 bit = 131072 counts

Gear ratio = 1:100

$$\text{Acceptable range: } \frac{2 \times \pi \times 0.5}{131072 \times 100}$$

If motor moves 100 counts, movement at endpoint is  $0.2 \times 10^{-6}$  meter.  
Acceptable range: 50-100.

### 9.6.3 Recording Data in Terminal

#### Procedure – Recording Data (Terminal)

1. Use the command RECORD to define the variables to be recorded, the recording interval, and the number of points to record.

The syntax for the recording instruction is:

```
RECORD {sample time} {num points} {var1} [var2] [var3]
```

For example: RECORD 32 100 "VCMD "V "ICMD

Records 100 points for VCMD, V, and ICMD every 1 milliseconds

Note that variables must be preceded by a quotation mark (").

2. Use the command RECTRIG to define the variable and conditions that triggers the recording.

The syntax for the recording trigger instruction is:

```
RECTRIG {var} [level] [pre-trig] [above|below]
```

**Note:** If the specified number of pre-trigger points is greater than the number of points actually recorded prior to the trigger, the pre-trigger segment of the recording will include the value of the variable before motion began.

For example, record a Jog (J) that goes to 1000 rpm starting from zero with an acceleration of 10000 rps/s; specify the record level at 1 rpm, the direction as Up, 128 pre-trigger points and a time interval of 1. Since there will not be 128 points of pre-trigger motion, the record data will be packed with zeros (zero velocity command before the motion).

3. Use the variable RECDONE (recording finished) and/or RECING (recording in progress) to determine whether recorded data is available.
4. Set variable GETMODE to 0. Then use the command GET to retrieve the recorded data in a comma-separated variable (CSV) ASCII format.

Function	VarCom	Description
<b>Recording Activation Commands</b>	RECORD	Defines the variables to be recorded and the recording time span and sample time.
	RECTRIG	Defines the triggering condition for starting a recording, and also pre-trigger duration.

Function	VarCom	Description
	RECOFF	Turns active recording off.
<b>Recording Utility Information</b>	RECLIST	Lists all the variables that can be recorded by the record function.
	RECTRIGLIST	Lists all the options for triggering the recording.
<b>Status Flags</b>	RECRDY	Indicates that a recording is armed and ready.
	RECING	Indicates that a trigger condition has occurred and that a recording is active.
	RECDONE	Indicates that the recording is completed
<b>Data Retrieval</b>	GETMODE	Defines the format for the recorded data (binary/ASCII)
	GET	Retrieves the recorded data

### 9.6.4 Evaluating PTPVCMD

Parameter PTPVCMD (position command generator velocity) reports the derivative of the position command profile in velocity units. PTPVCMD is useful for recording and viewing the actual velocity and the velocity command, which is available only as a derivative of the position profile.

PTPVCMD is the trajectory velocity command applicable to all position loops.

**Note:** VCMD is the output velocity command of the linear controller.  
VCMD is not used in HD (nonlinear) control.

The following figure shows an example of a PTPVCMD recording that indicates poor performance.

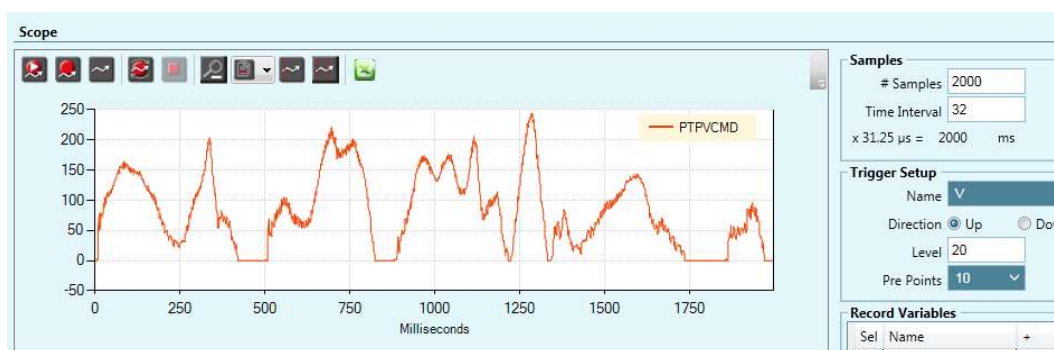
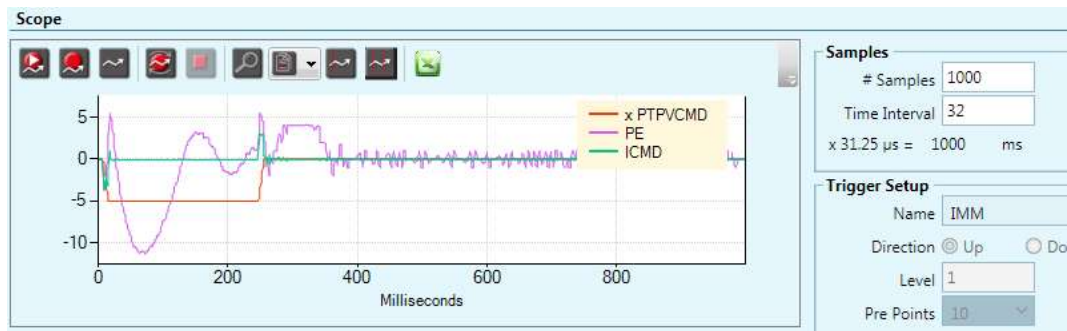


Figure 9-20. PTPVCMD Poor Result

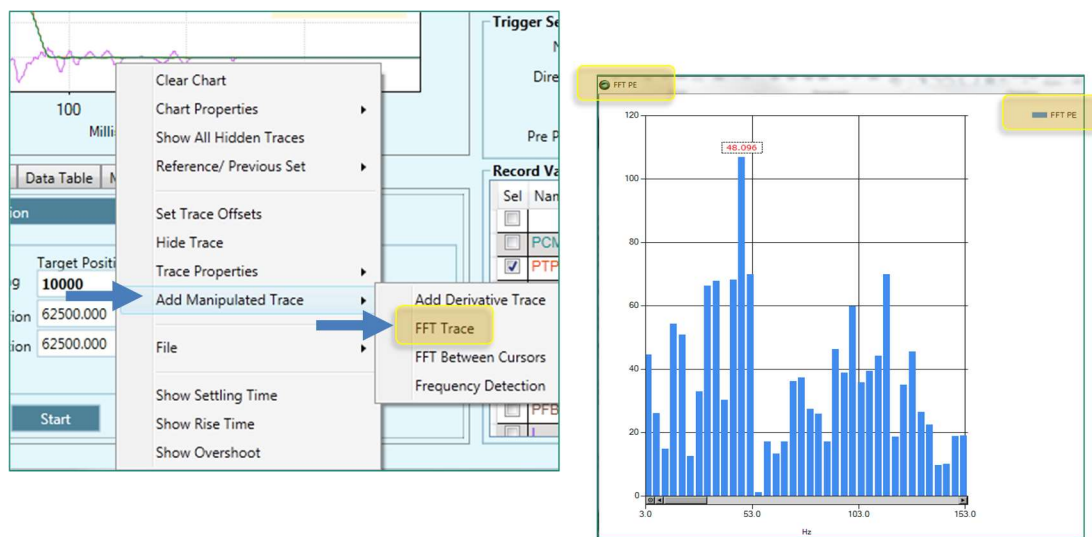
### 9.6.5 Evaluating ICMD and/or PE Oscillations

The following figure shows an example of oscillations in ICMD (current command) and PE (position error) that indicate poor performance.



**Figure 9-21. ICMD and PE Poor Result**

To determine whether the oscillations are greater than 300 Hz, use the Flexi SUITE FFT function on the PE or ICMD recording:



**Figure 9-22. FFT Trace Evaluation**

## 9.7 Low Pass Filter on Current Command

The output of the HD control loop is a current command. This current command is low pass filtered before it is transferred to the current controller.

The Autotuning procedure sets the optimal values for the low pass filter parameters during the Load Estimation routine.

- **NLFILTDAMPING** (HD Current Filter Damping), defined as a percentage, maintains the bandwidth of the filter up to the cutoff frequency.
- **NLFILTT1** (HD Current Filter Low Pass Rise Time), defined in milliseconds, defines the inverse of the cutoff frequency.

If acoustical noise occurs, it may be necessary to fine-tune the low pass filter. Increase NLFILTT1 in incremental steps of 10% until the acoustical noise reaches an acceptable level.

If the system becomes unstable, it may be necessary to reduce global gain (KNLUSERGAIN).

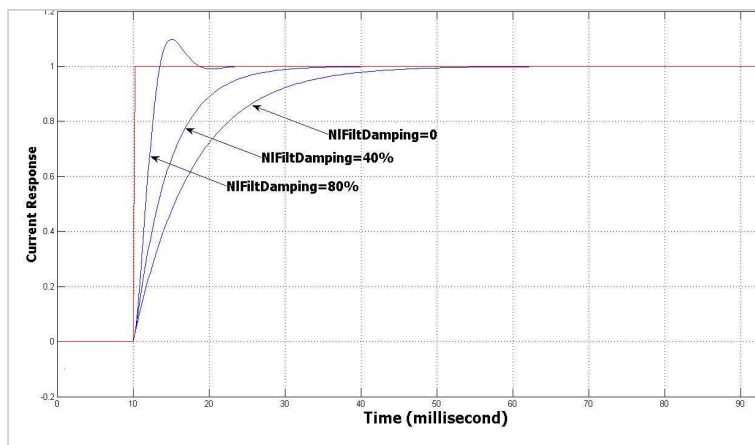
After KNLD is tuned, NLFILTDAMPING and/or NLFILTT1 can undergo further tuning. Refer to KNLD - Derivative Gain

To achieve the fastest response time of the HD control loop, the low pass filter can be adjusted manually. The goal is to use the maximum value for NLFILTDAMPING and the minimum value for NLFILTT1.

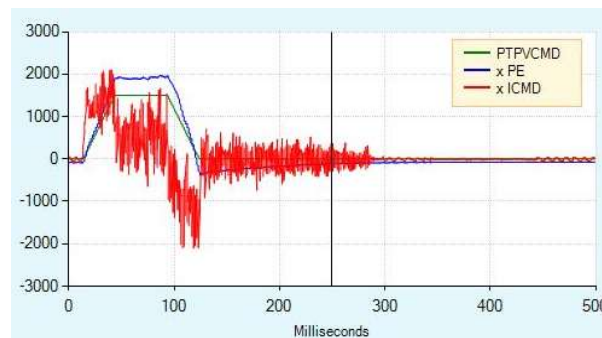
1. Increase NLFILTDAMPING until noise and/or oscillations of ICMD are observed, then reduce by 10%.
2. Decrease NLFILTT1 until noise and/or oscillations of ICMD are observed, then increase by 20% and at least 0.05 ms.

If the plant to be controlled has resonances at relatively high frequencies, NLFILTT1 can be applied on the current output. NLFILTT1 efficiently reduces acoustical noise, but also reduces control bandwidth and the potential stiffness of the system.

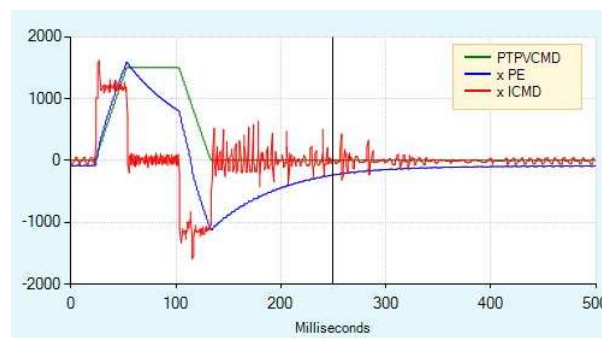
NLFILTDAMPING minimizes the negative effects of the low pass. NLFILTDAMPING may be set independently of NLFILTT1 to provide an overshoot response. Combined with the low pass characteristic of the mechanical system, it helps in achieving a higher bandwidth of the control.



NLFILTDAMPING at 0% 40% 80%



NLFITT1 value too low



NLFITT1 selected value

**Figure 9-23. Low Pass Filters**



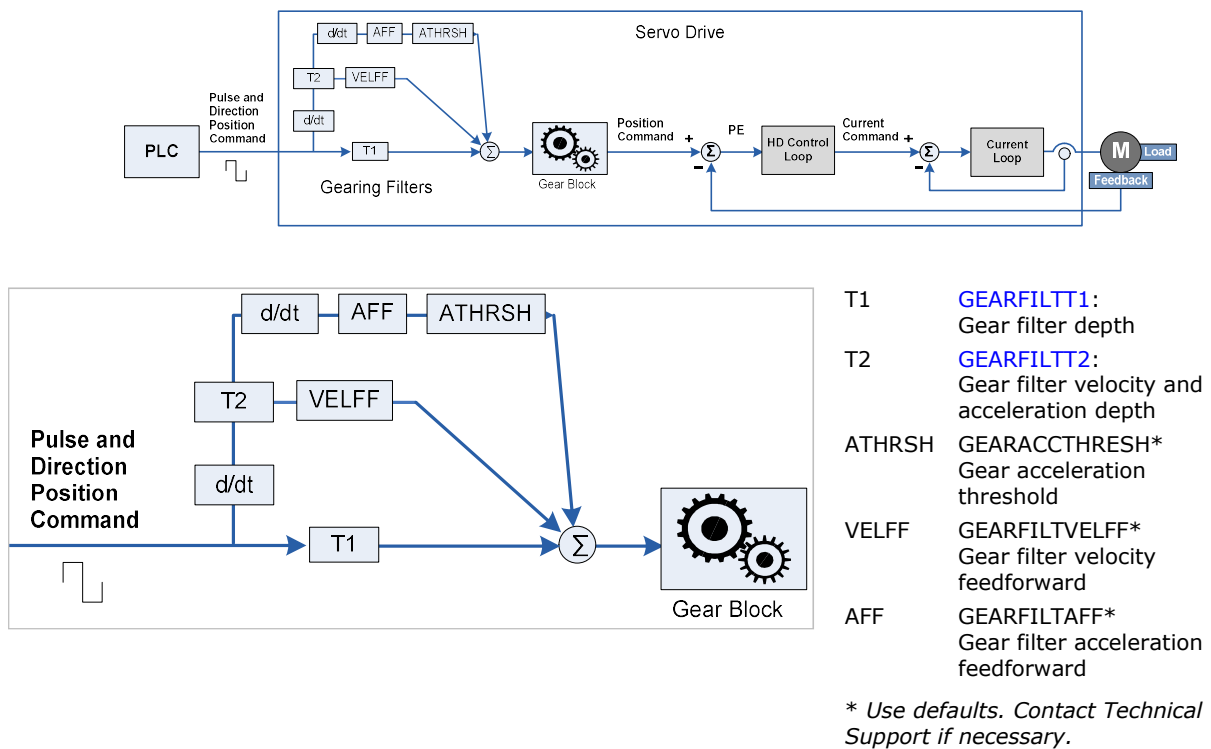
## 9.8 Gearing Filters

Gearing filters may be useful if the system displays characteristics such as:

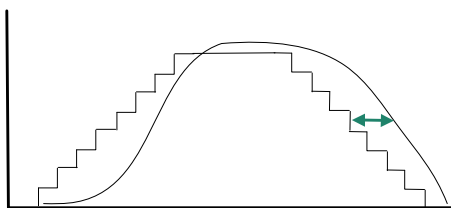
- Pulse and direction command has a low resolution
- Coupling between motor and load is not stiff
- Movement is too short
- Motor is noisy after tuning
- Current is very choppy during settling
- Motor temperature is unusually high

Before applying gearing filters, make sure GEARINMODE = 1

When a system has multiple axes, gear filter values must be the same for all axes.



**Figure 9-24. Gearing Filters**



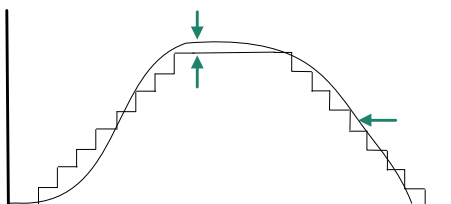
### Gearing Filter – Example 1

Increasing GEARFILTT1 smooths the input command PTPVCMD, but adds a delay.

Recommended values:

$$\text{GEARFILTT1} = \sim 2 \times \text{input step width}$$

$$\text{GEARFILTT2} = 2 \times \text{GEARFILTT1}$$



### Gearing Filter – Example 2

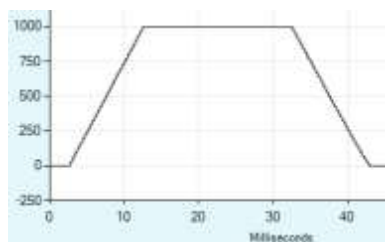
Increasing GEARFILTT2 and VELFF compensates for the delay, but adds overshoots.

If  $\text{GEARFILTVELFF} = \text{GEARFILTT2}$ , there is no delay.

**Figure 9-25. Tuning Gearing Filters**

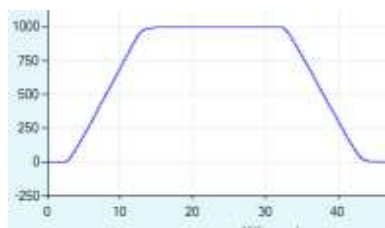
## 9.9 Move Smoothing Filter

HD control provides three options for smoothing the position command, as defined by the parameter [MOVESMOOTHMODE](#).



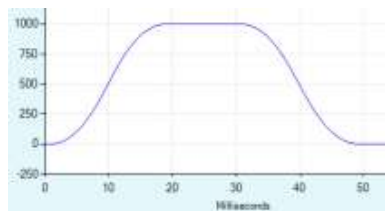
MOVESMOOTH 0:

No smoothing of the position command profile.



MOVESMOOTH 1:

Low pass smoothing of profile (in hertz) based on [MOVESMOOTHLPFHZ](#). The lower the value, the greater the smoothing.



MOVESMOOTH 2:

S-curve by averaging (in ms) based on [MOVESMOOTHAVG](#). Time extends the average. Binary values (2, 4, 8, 32, 64, 128, 256)

**Figure 9-26. Smoothing Filters**

To apply a smoothing filter to an external reference command, such as a pulse train or EtherCAT/CANopen, certain bits in [MOVESMOOTHSRC](#) must first be set.

## 9.10 Notch Filters

Notch filters can be used to eliminate high frequency oscillations that may occur in systems having a flexible link between motor and load, such as:

- Ballscrew linear slide with coupling
- Belt drive
- Harmonic drive

Oscillations usually occur during the first steps in tuning (feedback gain). Tuning is done by checking the frequency of the oscillation, and setting the notch accordingly. Once notch parameters are set, the tuning procedure can continue.

HD control notch filters are used at any time during tuning to damp oscillations at a fixed frequency greater than 300 Hz:

- [NLNOTCHCENTER](#) (HD Current Filter – Notch Filter Center)
- [NLNOTCHBW](#) (HD Current Filter – Notch Filter Bandwidth)

A second set of HD control notch filters ([NOTCH2CENTER](#) and [NLNOTCH2BW](#)) is available through Terminal, but does not appear in the Flexi SUITE control loop screen.

## 9.11 Anti-Vibration Filters

### Anti-Vibration Overview

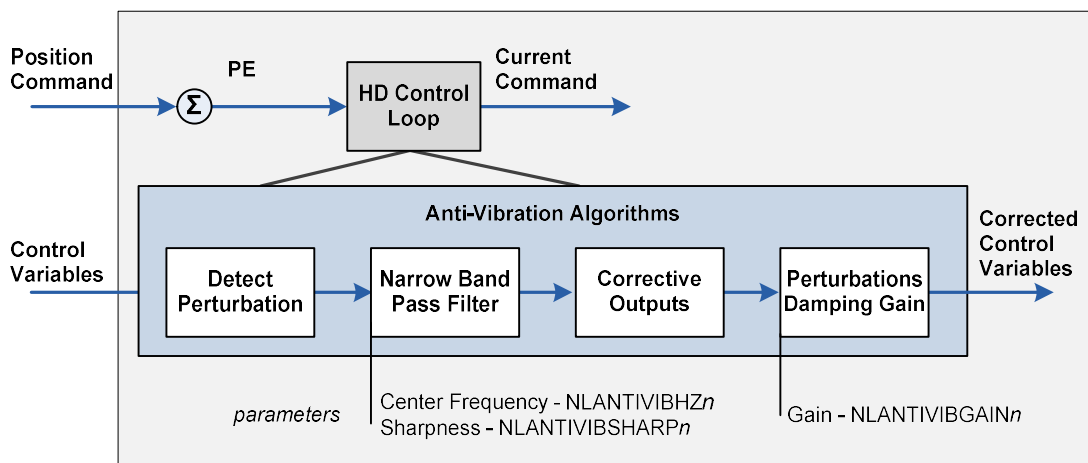
The HD control anti-vibration function is based on proprietary control algorithms and serves to suppress vibrations at constant frequencies.

The vibration suppression function runs in a closed loop, detecting oscillations as they occur, and damping them immediately. Actively damping load oscillations significantly reduces the time it takes for a heavy load or an end effector to settle at the target position. Although the position error at the encoder level may be higher, the overall performance of the system, as evaluated at load position, is significantly improved.

A typical example is a load fixed to a servo controlled motor by means of a shaft that has a certain amount of flexibility. If the servo control of the motor is set for near-zero position error during movement, then the load will oscillate strongly. Every change in the acceleration (jerk) will apply a perturbation, resulting in oscillations of the load. While the stiff HD control loop will overcome these oscillations at motor position level, the load will still oscillate strongly.

The anti-vibration function can handle systems with an oscillation frequency of up to 100 Hz.

The following diagram shows the four phases of the vibration suppression process.



**Figure 9-27. Anti-Vibration Filters**

**Phase 1:** The perturbations induced to the system are detected using various control variables, such as position error and current, as input. A perturbation value is calculated for use in the next phase.

**Phase 2:** The perturbation value is passed through a narrow band pass filter in order to select the perturbations that are induced by the system oscillations. The center frequency and the width of the band pass filter are set, respectively, by the parameters **NLANTIVIBHZ<sub>n</sub>** and **NLANTIVIBSHARP<sub>n</sub>**.

**Phase 3:** Corrective outputs to be added to the control variables are calculated.

**Phase 4:** Corrective outputs are added to control variables using a damping gain (parameter **NLANTIVIBGAIN<sub>n</sub>**).

### Anti-Vibration Tuning Procedure

After autotuning, more anti-vibration tuning may be required.

If an additional vibration frequency needs to be suppressed, the turning process can be repeated using the second set of anti-vibration filters.

The following table shows the parameters whose values are modified by the HD tuning procedures.

HD Anti-Vibration Filter	Parameter	Default	Range
<b>Center Frequency 2</b>	<b>NLANTIVIBHZ2</b>	<b>100</b>	<b>5 to 800 [Hz]</b>
Center Frequency 3	NLANTIVIBHZ3	400	5 to 800 [Hz]
<b>Sharpness 2</b>	<b>NLANTIVIBSHARP2</b>	<b>0.5</b>	<b>0.01 to 10</b>
Sharpness 3	NLANTIVIBSHARP3	0.2	0.01 to 10
<b>Damping Gain 2</b>	<b>NLANTIVIBGAIN2</b>	<b>0</b>	<b>0 to 99</b>
Damping Gain 3	NLANTIVIBGAIN3	0	0 to 6

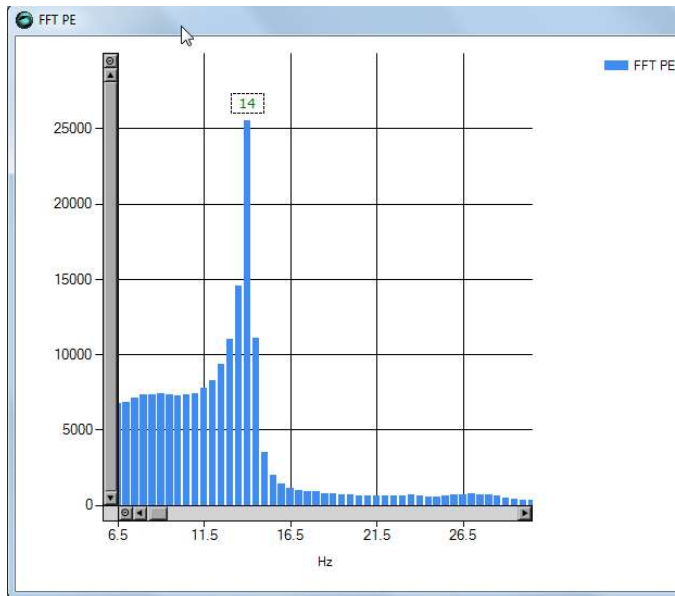
**Note:** Although parameters NLANTIVIBHZ, NLANTIVIBSHARP and NLANTIVIBGAIN are still available, they are not recommended for use.

## Step 1 – Setting the Narrow Band Filter (NBF)

### 1. Set the narrow band center frequency.

- Execute a movement and measure the resonance (oscillation frequency) of the current command (ICMD):
  - In the **Scope** screen, right-click on the ICMD plot.
  - Select **FFT and Derivative**.
  - Select **FFT Trace**.

The FFT trace will look like this, for example:

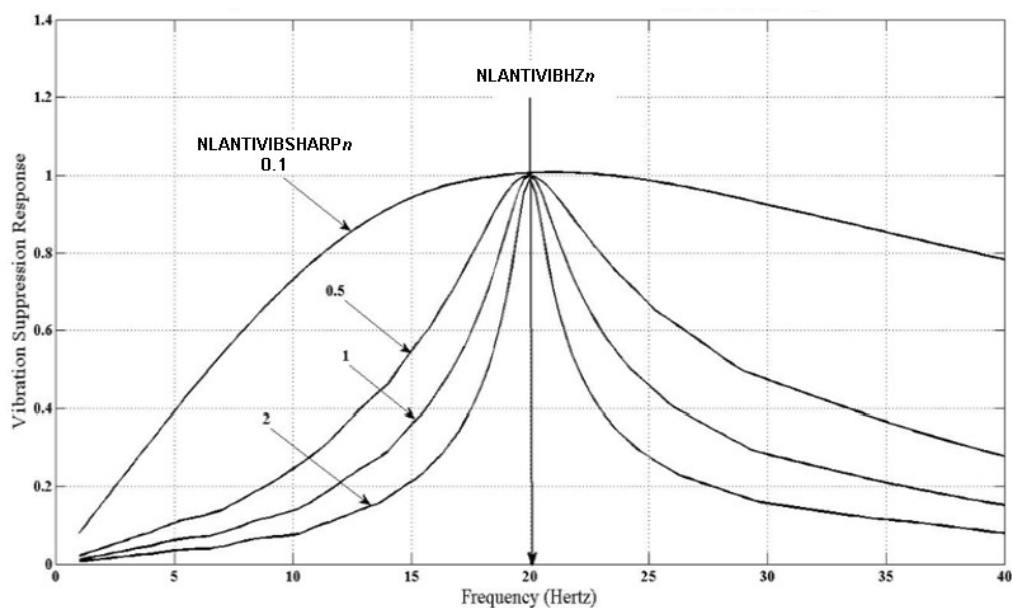


**Figure 9-28. FFT Trace**

- Set the value of parameter  $NLANTIVIBHZn$  to the peak, or dominant, resonance, in Hertz. In the example shown here, the value is 14 Hz.
- ### 2. Set the narrow band center sharpness (width).
- Set the value of parameter  $NLANTIVIBSHARPn$  according to the resonance sharpness (width) of the narrow band filter.

Estimate the width by visually comparing the graph in the FF Trace dialog box to the graph below, which shows the frequency response of the NBF as a function of the value of  $NLANTIVIBSHARPn$ . Typical setting values range from 0.1 to 1.0.

The following diagram shows the narrow band filter frequency response.



**Figure 9-29. Frequency response as a function of NLANTIVIBSHARP $n$  for 20 Hz center frequency**

### Step 2 – Tuning the Damping Gain

Increase parameter NLANTIVIBGAIN $n$  until optimal damping is achieved.

- At each increment, record the current command (ICMD) and check the oscillation damping.

Optimal damping of the system is obtained for the best damped current oscillations.

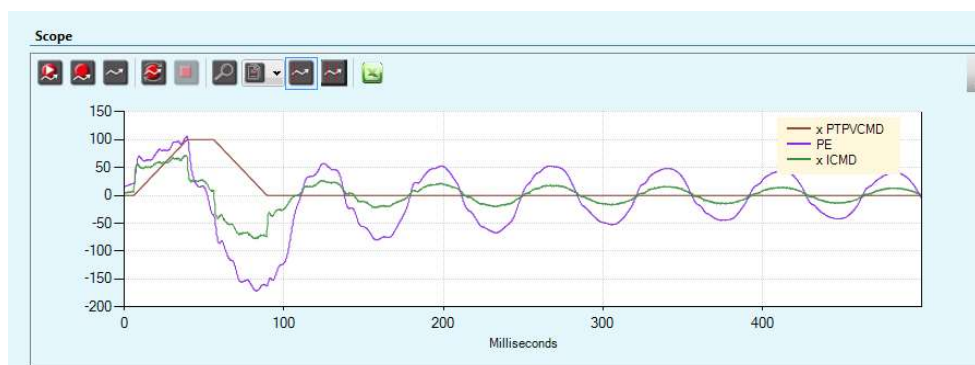
**Note:** When performing this step, the position error plot is not a good indicator, as it may still be oscillating while the current, and thus the load, are smoothly settling down.

- If, while increasing this parameter, a high frequency vibration appears, slightly reduce the adaptive global gain (KNLUSERGAIN).

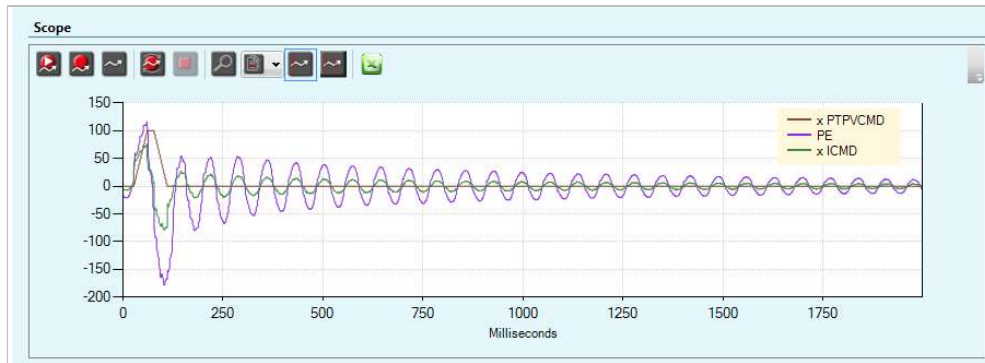
### Anti-Vibration Tuning Example

**Note:** Plots of some variables are scaled (indicated by "x").

Without the vibration suppression tuning, position error and current oscillate, and settling time is very long.



**Figure 9-30. Without vibration suppression, oscillation of position error and current**



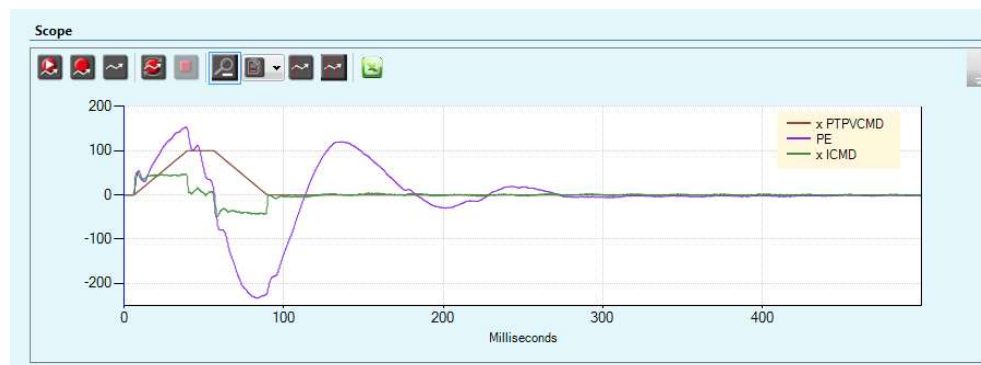
**Figure 9-31. Without vibration suppression, long settling time**



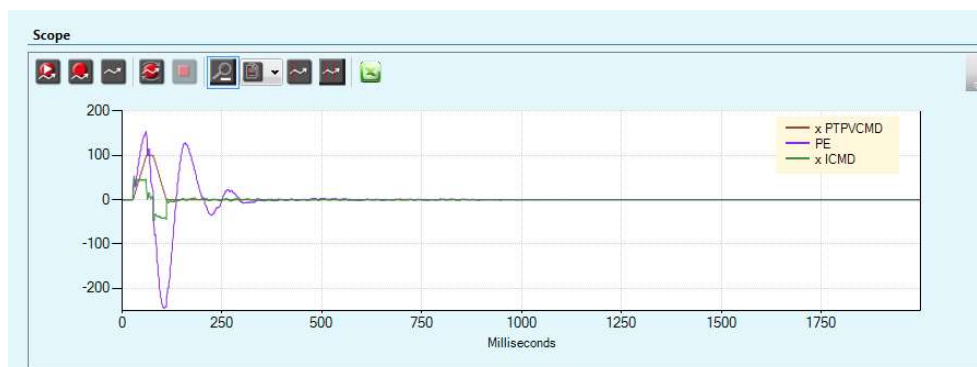
**Figure 9-32. Settling time – no anti-vibration tuning**

To damp the oscillations and reduce settling time, the following parameters are set:

- NLANTIVIBHZ2 = 14 Hz, frequency of the measured resonance.
- NLANTIVIBSHARP2 = 0.5, width estimated according to the sharpness displayed in the FFT trace.
- NLANTIVIBGAIN2 = 8, determined by manually increasing the value from 0, until best settling time is achieved.



**Figure 9-33. Tuning for vibration suppression, less oscillation of position error and current**



**Figure 9-34. Tuning for vibration suppression, faster settling time**



**Figure 9-35. Settling time – with anti-vibration tuning**

## 9.12 Gains – Manual Tuning

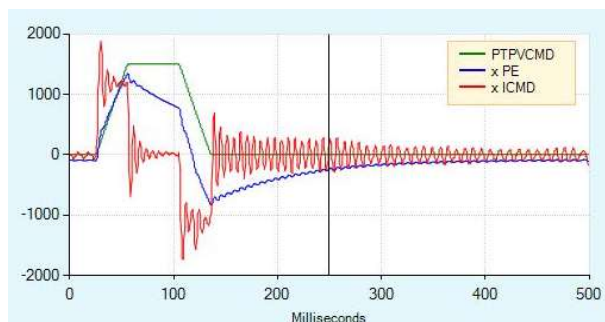
### KNLD - Derivative Gain

1. Set KNLP to half the value that was set by default.
2. Set KNLI and KNLIV to zero.
3. Increase KNLD until oscillations of ICMD are observed.

The acceptable level of ICMD ripple depends on the system, primarily the load. It can often be judged by the acoustical noise.

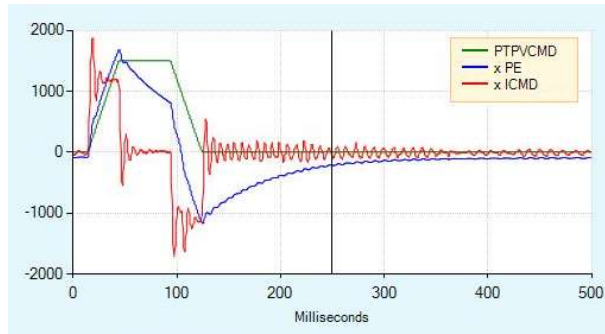
Light loads (LMJR < 2): 5% of rated current may be normal.

Higher loads (LMJR > 2): 10% of rated current may result in acceptable ripple.



KNLD value too high





KNLD selected value

**Figure 9-36. Derivative Gain Tuning**

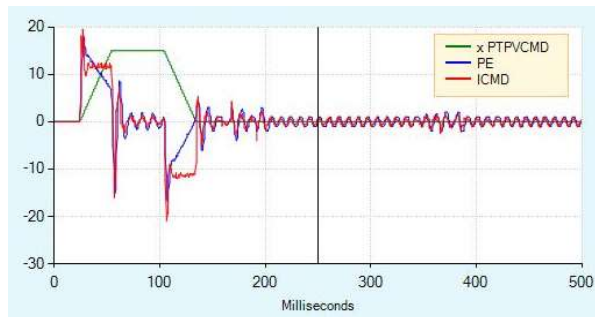
**KNLIV - Derivative-Integral Gain**

Increase KNLIV until position error (PE) begins to oscillate.

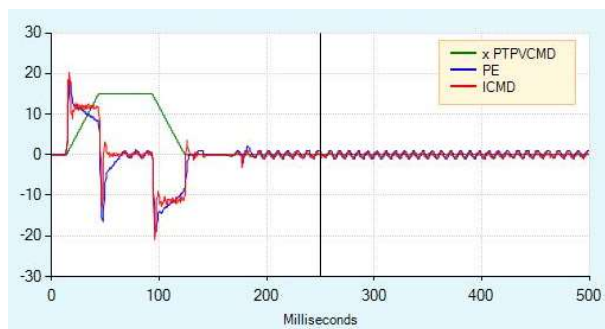
Increasing KNLIV reduces the position error, reduces sensitivity to external perturbations, and reduces the steady state position error at stop (if exists).

**Best tuning:** Position error decreases as fast as possible after each movement phase transition (jerk), without oscillations during transition between phases; no overshoot of position error; oscillations at stop are acceptable ( $\pm 1$  encoder count).

**Best settling time:** If possible, increase KNLIV until position error returns to 0 before the end of the deceleration phase.



KNLIV value is too high; vibrations at stop are too strong; overshoot of position error



KNLIV selected value; good settling time

**Figure 9-37. Derivative-Integral Gain Tuning**

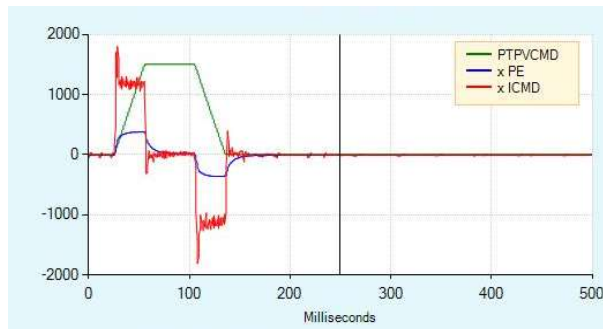
## KNLP - Proportional Gain

Increase KNLP until position error (PE) begins to oscillate.

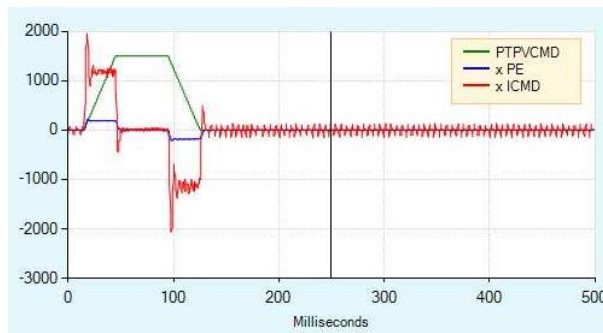
As the value of KNLP increases, the shape of the position error become square, reflecting the constant values during acceleration and deceleration.

As the KNLP proportional gain gets higher, the position error reaches a steady value during each phase of the movement (acceleration, plateau, deceleration).

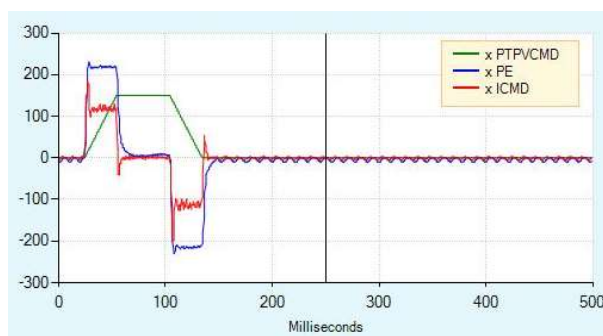
**Best tuning:** Graph is as square as possible, indicating the position error is constant during each phase of movement, and there are no oscillations during the transition between phases (acceleration to plateau, plateau to deceleration, deceleration to stop).



PE gets flatter during acceleration and deceleration



KNLP value too high; vibrations at stop



KNLP selected value

**Figure 9-38. Proportional Gain Tuning**

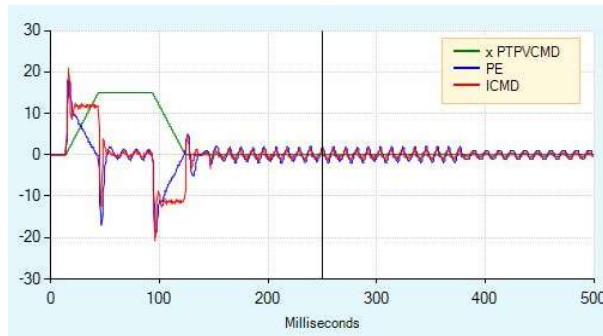
## KNLI - Integral Gain

KNLI is used to reduce the position error during movement and at stop.

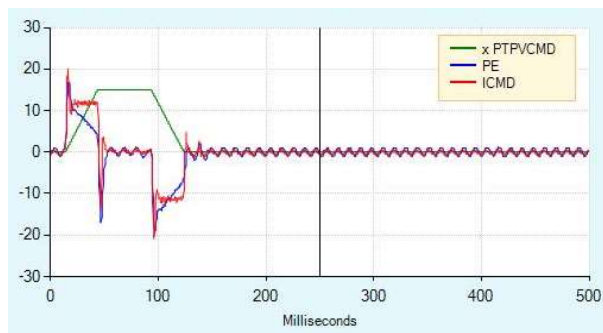
**Best tuning:** Maximum value that does not create overshoot or oscillations.

**Best settling time:** If possible, increase KNLI until position error returns to 0 before the end of the deceleration phase.

**Result:** Position error is slightly reduced; oscillations at stop are acceptable ( $\pm 1$  encoder count); no overshoot of position error at end of deceleration phase (stopping point).



KNLI value too high; position error oscillations at stop; overshoot of position error



KNLI selected value

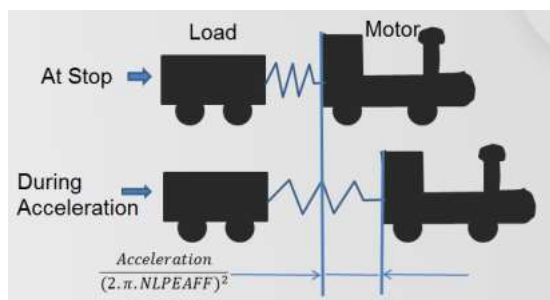
**Figure 9-39. KNL Tuning**

## 9.13 Flexibility Compensation Tuning

The flexibility compensation parameters reduce the vibrations induced to the load by abrupt changes in acceleration (jerk), and reduce tracking error. They also serve to minimize overshoot and settling time.

- **NLPEAFF** (HD Flexibility Compensation), defined in Hertz, is set according to the rigidity of the system. Rigid systems require a high value. Systems with high load inertia and flexible couplings require lower values; the normal range is 400 to 30 Hz). If not used, set to 5000 Hz.
- **NLAFFLPFHZ** (HD Spring Filter), defined in Hertz, applies a low pass filter on the acceleration of the command position used to perform the compensation. This acceleration is calculated from the input command position, and may be noisy if the input command position has a relatively low resolution, as for example a pulse train input. Application of the low pass filter NLAFFLPFHZ smoothes the calculated acceleration of the command position, and should be used whenever noisy operation is observed while applying the parameter NLPEAFF.

**Best tuning:** Typically, the highest frequency is 400 Hz. Thus, for heavily loaded and flexible systems, typical range for NLPEAFF is 400 to 30 Hz.



**Figure 9-40. Plant Flexibility**

### Procedure – Flexibility Compensation Tuning

1. Set **NLAFFLPFHZ** =  $3 \times \text{KNLD}$
2. Start with highest value of **NLPEAFF**, and reduce until the best result for the application is achieved. Criteria may be either settling time or position error.

## 9.14 Tuning Issues – Q&A

*When should a notch filter be used?*

If your plant has a high frequency vibrations, and produces shrieking or honking sounds when you raise the gain.

*Although system performance is good, the system produces a lot of acoustical noise at low speeds. What should be done?*

Tune the system at a high speed, reduce global gain **KNLUSERGAIN**, increase low pass filter rise time **NLFILTT1**, and then increase **NLMAXGAIN**.

*The system has flexibility, and overshoots at the end of the movement. How can overshoot be eliminated?*

Use a low value of acceleration filter **NLAFFLPFHZ** and decrease **NLPEAFF**. This will create an undershoot before the stop and eliminate the overshoot.

# 10 Diagnostics and Troubleshooting

## 10.1 Report Generator

Before contacting Technical Support, create a report of application settings by means of the Report Generator in Flexi SUITE. The information contained in the report files will enable Technical Support to troubleshoot your problem and provide assistance.

In general, it is strongly recommended that you create a report whenever you complete configuration of your application, even when the system is functioning properly.

The Report Generator option can be accessed in Flexi SUITE in two locations:

- Autotuning wizard (final step)
- Backup & Restore screen

## 10.2 Faults and Warnings

If the FLEXI PRO is connected to a host computer via a serial connection, it communicates fault codes to the computer by means of a text message. This message is saved in a fault history log (FLTHIST) in the drive's non-volatile memory, so that the fault history is not lost when power is removed from the drive.

- **Warnings** are not considered faults and do not disable operation. The system automatically clears the warning state when the condition that generated the warning no longer exists.
- **Faults** occur when settings or conditions may cause improper operation of the drive/motor and/or equipment damage. Faults automatically disable the drive, and a fault status is indicated on the drive's display and in the software interface.

The drive fault status is generally latched, and the drive cannot be enabled until the fault status is explicitly cleared. Only if the fault condition no longer exists can the fault status be cleared. It is done by either of the following:

- Toggling the drive enable. This is done either by executing a drive disable command (K) followed by the enabled (EN) command or by toggling the Remote Enable line (REMOTE).
- In some systems, a specific drive input is defined as Alarm Clear. In this case, toggling the input will clear the fault.

When the fault condition no longer exists, the drive is reenabled.

- Some faults are referred to as **fatal faults** since they disable almost all drive functions (including communications) and prevent the drive from being enabled. This condition is typical of faults due to internal failures, such as a watchdog event or a failure of an internal power source. Fatal faults require intervention by Technical Support.

VarCom	Description
<a href="#">CLEARFAULTS</a>	Clears all latched faults.
<a href="#">FLT</a>	Returns a list of faults latched by the drive.
<a href="#">FLTHIST</a>	Returns the contents of the fault buffer.
<a href="#">K   EN</a>	Disable drive   Enable drive
<a href="#">READY</a>	Indicates whether drive is ready to be enabled.
<a href="#">REMOTE</a>	Indicates the state of the external hardware enable input.
<a href="#">ST</a>	Returns detailed drive status messages.

## 10.3 Fault, Warning and Error Codes and Messages

The following tables present the fault, warning and error codes that may be displayed when working in Terminal.

All faults, and many warnings, are also indicated by the drive's 7-segment display. Certain conditions generate on-screen warning messages only.

### 10.3.1 Warnings

WRN #	Warning Message <i>(click description for more info)</i>
WRN 1	<a href="#">STO Warning</a>
WRN 2	<a href="#">Drive Foldback Warning</a>
WRN 3	<a href="#">Motor Foldback Warning</a>
WRN 4	<a href="#">Under-Voltage</a>
WRN 5	<a href="#">Power Stage Over-Temperature</a>
WRN 6	<a href="#">Motor Over-Temperature</a>
WRN 9	<a href="#">Control Board Over-Temperature</a>
WRN 10	Phase Find Required Phase difference is required to initialize the commutation angle.
WRN 11	PLL Not Synchronized Phase locked loop (PLL) has not been synchronized (SYNCSOURCE>0).
WRN 15	<a href="#">Hardware Positive Limit Switch is Open</a>
WRN 16	<a href="#">Hardware Negative Limit Switch is Open</a>
WRN 17	<a href="#">Hardware Positive and Negative Limit Switches are Open</a>
WRN 18	<a href="#">Software Positive Limit Switch is Tripped</a>
WRN 19	<a href="#">Software Negative Limit Switch is Tripped</a>
WRN 20	<a href="#">Software Limit Switches are Tripped</a>
WRN 21	HIPERFACE Encoder Resolution Mismatch Encoder resolution determined from the detected HIPERFACE device is not the same as the MENCRES settings currently in effect.
WRN 22	<a href="#">Multi-turn Encoder Battery Low Voltage</a>

<b>WRN #</b>	<b>Warning Message</b> <i>(click description for more info)</i>
WRN 24	EnDat Encoder Resolution Mismatch Mismatch between MENCRES and encoder resolution as read during initialization process.
WRN 25	PFB Backup Not Read PFBBACKUP data has not yet been received.
WRN 27	<a href="#">Offset and/or Gain Adjustment Values Detected After SININIT</a>
WRN 32	<a href="#">Bus AC Supply Line Disconnected</a>
WRN 34	<a href="#">Regen Resistor Overload</a>
WRN 35	SensAR: Encoder Warning Drive detected a warning on SensAR.
WRN 36	<a href="#">Realtime Overload Warning</a>
WRN 37	<a href="#">Cannot Use SFBTYPE 1 with Analog OPMODE</a>
WRN 38	<a href="#">Integrated Power Module Over-Temperature</a>
WRN 40	Online LMJR Estimation Active Online LMJR estimation active.
WRN 41	PDO Packet is Not the Expected Length (too long) PDO packet is not the expected length according to PDO mapping. It is too long.
WRN 42	Data in RPDO is Out of Range Data in RPDO is out of range or exceeds minimum/maximum limits.
WRN 43	Data Cannot Be Written When Drive is Enabled RPDO data cannot be written when drive is enabled.
WRN 44	Command is Toward Positive Software Limit Command is toward negative software limit.
WRN 45	Command is Toward Negative Software Limit Command is toward positive software limit.
WRN 47	CAN Communication Entered Passive State CAN communication error on bus
WRN 48	Default drive configuration The drive configuration is the default factory setting
WRN 49	Fieldbus target command lost The fieldbus controller has not sent a target command in 3 consecutive instances.
WRN 50	I2C Failed To Read Temp Sensor
WRN 51	BiSS-C Encoder Indicates an Internal Warning
WRN 52	Motor Compatibility Warning.
WRN 53	Conflicting Digital Inputs On

### 10.3.2 Faults

<b>FLT #</b>	<b>Fault Message</b> <i>(click description for more info)</i>
FLT 1	<a href="#">Drive Locked</a>
FLT 2	<a href="#">Parameter Memory Checksum Failure</a>
FLT 3	<a href="#">Over-Current</a>
FLT 4	<a href="#">STO Fault</a>
FLT 5	<a href="#">FPGA Config Failed</a>
FLT 6	<a href="#">Control EEPROM Fault</a>
FLT 7	<a href="#">Power EEPROM Fault</a>
FLT 8	<a href="#">Vbus Measure Circuit Failed</a>
FLT 9	<a href="#">Over-Voltage</a>
FLT 10	<a href="#">Power Stage Over-Temperature</a>
FLT 11	<a href="#">Under-Voltage</a>
FLT 12	<a href="#">Not Configured</a>
FLT 13	<a href="#">Failure Writing to Flash Memory</a>
FLT 14	<a href="#">Velocity Over-Speed Exceeded</a>
FLT 15	<a href="#">Encoder Simulation Frequency Too High</a>
FLT 16	<a href="#">Drive Foldback</a>
FLT 17	<a href="#">Motor Foldback</a>
FLT 18	<a href="#">A/B Line Break</a>
FLT 19	<a href="#">Invalid Halls</a>
FLT 20	<a href="#">Index Line Break</a>
FLT 21	<a href="#">Sine Feedback Communication Fail</a>
FLT 22	<a href="#">A/B Out of Range</a>
FLT 23	<a href="#">Motor Over-Temperature</a>
FLT 24	<a href="#">Sine Encoder Quadrature Fault</a>
FLT 25	<a href="#">Sin/Cos Calibration Invalid</a>
FLT 26	<a href="#">Feedback 5V Over-Current</a>
FLT 27	<a href="#">Secondary Feedback Index Break</a>
FLT 28	<a href="#">Secondary Feedback A/B Line Break</a>
FLT 29	<a href="#">Regen Over-Current</a>
FLT 30	<a href="#">Fieldbus Velocity Limit Exceeded</a>
FLT 31	<a href="#">Secondary Encoder 5V Over-Current</a>
FLT 32	<a href="#">CAN Supply Fault</a>
FLT 33	<a href="#">Self Test Failed</a>
FLT 34	<a href="#">Feedback Communication Error</a>



---

<b>FLT #</b>	<b>Fault Message</b> <i>(click description for more info)</i>
FLT 35	<a href="#">Nikon Encoder Operational Fault</a>
FLT 36	<a href="#">Plus 15V Out of Range</a>
FLT 37	<a href="#">Minus 15V Out of Range</a>
FLT 38	<a href="#">Watchdog Fault</a>
FLT 39	<a href="#">Integrated Power Module Over-Temperature</a>
FLT 40	<a href="#">Control Board Over-Temperature</a>
FLT 41	<a href="#">Phase Find Failed</a>
FLT 42	<a href="#">Tamagawa Init Failed</a>
FLT 43	<a href="#">Current-Sensors Offset Invalid</a>
FLT 44	<a href="#">Motor Setup Failed</a>
FLT 45	<a href="#">Exceeded Maximum Position Error</a>
FLT 46	<a href="#">Pulse and Direction Input Line Break</a>
FLT 47	<a href="#">FPGA Version Mismatch</a>
FLT 48	<a href="#">PLL Synchronization Failed</a>
FLT 49	<a href="#">Tamagawa Abs Operational Fault</a>
FLT 50	<a href="#">CAN Heartbeat Lost</a>
FLT 51	<a href="#">Motor Phases Disconnected</a>
FLT 52	<a href="#">5V Out of Range</a>
FLT 55	<a href="#">Resolver Initialization Failed</a>
FLT 56	<a href="#">Multi-turn Encoder Battery Low Voltage</a>
FLT 57	<a href="#">Emergency Stop Issued</a>
FLT 58	<a href="#">Endat2X Feedback Fault</a>
FLT 59	<a href="#">Stall Fault</a>
FLT 60	<a href="#">PFB Off Checksum Invalid</a>
FLT 61	<a href="#">PFB Off Data Mismatch</a>
FLT 62	<a href="#">No PFB Off Data</a>
FLT 65	<a href="#">Fieldbus Cable Disconnected</a>
FLT 66	<a href="#">Command Exceeds Acc/Dec Limits</a>
FLT 67	<a href="#">Exceeded Maximum Velocity Error</a>
FLT 68	<a href="#">Encoder Phase Error</a>
FLT 69	<a href="#">Fieldbus Target Command Lost</a>
FLT 70	<a href="#">Internal Error</a>
FLT 71	<a href="#">Differential Halls Line Break</a>
FLT 72	<a href="#">Logic AC Power Failure</a>
FLT 73	<a href="#">Temperature Sensor Failure</a>
FLT 76	<a href="#">Pulse Train Frequency Too High</a>
FLT 77	<a href="#">Commutation Error (Motor Runaway) Condition Detected</a>

<b>FLT #</b>	<b>Fault Message</b> <i>(click description for more info)</i>
FLT 78	<a href="#">Bus AC Supply Line Disconnect</a>
FLT 80	<a href="#">AqB Commutation Fault</a>
FLT 82	<a href="#">SensAR Encoder Fault</a>
FLT 83	<a href="#">Regen Resistor Overload</a>
FLT 85	<a href="#">Motor Plate Read Failed</a>
FLT 86	<a href="#">SAVE and Power Cycle Required</a>
FLT 87	<a href="#">Excessive PE Value</a>
FLT 88	<a href="#">CAN is in Bus-Off State</a>
FLT 89	<a href="#">Realtime Overload Fault</a>
FLT 90	<a href="#">Secondary Feedback Position Mismatch</a>
FLT 91	<a href="#">EtherCAT Packet Loss</a>
FLT 92	<a href="#">CAN/EtherCAT State Not Operational</a>
FLT 93	<a href="#">Fieldbus Version Mismatch</a>
FLT 94	<a href="#">ESI Version Mismatch</a>
FLT 95	<a href="#">Custom Absolute Encoder Operational Fault</a>
FLT 96	<a href="#">Digital Output Over-Current Fault</a>
FLT 98	<a href="#">Power Brake Fault</a>
FLT 99	<a href="#">Sankyo Absolute Encoder Fault</a>
FLT 100	<a href="#">Unstable Current Loop</a>
FLT 102	<a href="#">BiSS-C Encoder Indicates an Internal Fault</a>
FLT 103	<a href="#">HIPERFACE Data Error.</a>
FLT 104	<a href="#">High IQ Current Detected</a>
FLT 105	<a href="#">Digital Output Over-Current Fault</a>
FLT 106	<a href="#">Feedback Type Auto-Detect Failed</a>
FLT 107	<a href="#">EnDat Excessive Resolution Fault</a>
FLT 108	<a href="#">MOTORNAME/MTP Data Mismatch</a>
FLT 109	<a href="#">Firmware Version is Not Supported by this Drive</a>
FLT 110	<a href="#">ESI Vendor Mismatch</a>
FLT 111	<a href="#">MENCZPOS Mismatch with Halls</a>

### 10.3.3 Errors

<b>ERR #</b>	<b>Error Message</b>
ERR 0	No error
ERR 20	Unknown command
ERR 21	Unknown variable
ERR 22	Checksum error
ERR 23	Drive active
ERR 24	Drive inactive
ERR 25	Value out of range
ERR 26	Value too low
ERR 27	OPMODE invalid
ERR 28	Syntax error
ERR 29	Value too high
ERR 36	Not programmable
ERR 37	Not Configured
ERR 38	N/A
ERR 42	Flash invalid
ERR 43	Recording active
ERR 44	Recorded data not available
ERR 45	NVRAM empty
ERR 46	Value must be an even number
ERR 49	Value must be a multiple of 0.25
ERR 50	SAVE to flash failed
ERR 51	Not available
ERR 54	Command towards limit switch
ERR 55	Zeroing mode active
ERR 60	Motor in motion
ERR 62	Communication error
ERR 63	EnDat not ready
ERR 64	EnDdat CRC error
ERR 65	EnDat busy
ERR 66	Password protected
ERR 67	TM Write to EEPROM Failed
ERR 68	TM communication CRC failed
ERR 71	Homing type not in use
ERR 72	Homing type invalid

<b>ERR #</b>	<b>Error Message</b>
ERR 73	Homing trigger input not set
ERR 74	Homing already in progress
ERR 75	Homing direction input not set
ERR 82	Functionality already defined
ERR 94	Command exceeds software limits
ERR 95	Feedback invalid
ERR 96	Variable is not recordable
ERR 97	Value must be an integer
ERR 98	I/O not supported
ERR 99	Active Disable in progress
ERR 100	I2C bus is busy
ERR 102	Another procedure is running
ERR 103	Clear faults before procedure
ERR 104	Motion pending
ERR 105	Invalid PTP mode
ERR 106	Checksum invalid
ERR 107	Analog output mode invalid
ERR 108	Hold mode active
ERR 109	Motor commutation type invalid
ERR 112	HCICMD value out of range
ERR 113	HC actual velocity out of range
ERR 114	Not supported on this hardware
ERR 115	Value must be a multiple of 0.125
ERR 116	Fieldbus mode (COMMODE=1) active
ERR 201	Current loop design failed
ERR 202	MENCRES out of range
ERR 204	MSPEED out of range
ERR 206	MVANGLF out of range
ERR 210	VLIM out of range
ERR 212	MVANGLH out of range
ERR 213	DICONT greater than DIPEAK
ERR 214	MENCTYPE Mismatch
ERR 215	DIPEAK out of range
ERR 216	MIPEAK out of range
ERR 217	MICONT greater than MIPEAK
ERR 218	VBUS out of range

<b>ERR #</b>	<b>Error Message</b>
ERR 219	ML out of range
ERR 220	MPOLES out of range
ERR 221	Velocity loop design failed
ERR 222	Internal dual gain present
ERR 223	PHASEFIND required
ERR 224	Value is not allowed
ERR 225	Internal dual gain not present
ERR 226	MENCTYPE invalid for linear motor
ERR 227	ENCOUTRES too high
ERR 228	Function invalid for this input
ERR 229	MJ out of range
ERR 230	MMASS out of range
ERR 232	Autotuning active
ERR 233	Internal config failed
ERR 234	Feedback type mismatch
ERR 250	Velocity config failed
ERR 254	Cycle identification active
ERR 255	Phase find mode invalid
ERR 256	Feedback device disconnected
ERR 257	Feedback device initializing
ERR 260	No input assigned to touch probe
ERR 261	COMMERRVTHRESH exceeds VLIM
ERR 262	Other HDTUNEREFERENCE is active
ERR 263	SensAR: The device is busy
ERR 264	SensAR: Request timeout
ERR 265	SensAR: Flash save failed
ERR 266	SensAR: Protocol error
ERR 267	SensAR: Illegal request
ERR 268	SensAR: Address not aligned
ERR 269	Cannot read motor nameplate data
ERR 270	Cannot be set when MTPMODE>0
ERR 271	Cannot be set when COMMODE>0
ERR 272	POSCONTROLMODE not supported
ERR 274	Cannot be issued when SFBMODE>0
ERR 275	Trajectory distances not equal
ERR 276	Not supported on this feedback
ERR 277	Feedback returned too much data

<b>ERR #</b>	<b>Error Message</b>
ERR 278	HDTUNEAVMODE invalid
ERR 279	SensAR: Internal request error
ERR 280	SensAR driver is occupied
ERR 281	SensAR driver failed
ERR 282	SensAR driver acquire timeout
ERR 283	Drive is not homed
ERR 284	SensAR address is out of range
ERR 285	SensAR CRC error occurred
ERR 286	Autotune activation failed
ERR 287	Zero failed. Cannot zero if ILIM=0
ERR 288	Comm feedback defaults undefined
ERR 289	Feedback memory not partitioned
ERR 290	Cannot change in modulo mode
ERR 291	Mismatch in EnDat stamp value
ERR 292	EnDat 2.X not supported
ERR 293	MENCRES too high for this drive
ERR 294	HDTUNE Vcruise too low
ERR 295	HDTUNE distances not equal
ERR 296	Failed to store data on flash
ERR 297	Failed to read data from flash
ERR 298	CANopen internal error
ERR 299	CANopen: object index not found
ERR 300	CANopen: object sub index not found
ERR 301	CANopen: object size incorrect
ERR 302	CANopen: drive in wrong NMT state
ERR 303	SFBMODE unsupported in nonlinear
ERR 304	Use different sign for Pos and Neg
ERR 305	Use same sign for Pos and Neg
ERR 306	PHASEFINDMODE=4 with old KCMODE
ERR 307	CANopen: Cannot transfer data
ERR 308	Positive limit switch is active
ERR 309	Negative limit switch is active
ERR 310	Home switch in opposite state
ERR 311	Motion stopped abruptly
ERR 312	BiSS-C: address out of range
ERR 313	BiSS-C: the device is busy

<b>ERR #</b>	<b>Error Message</b>
ERR 314	BiSS-C: Illegal request
ERR 315	BiSS-C: EEPROM save failed
ERR 316	BiSS-C: busy timeout
ERR 317	BiSS-C: internal error
ERR 318	BiSS-C: protocol error
ERR 319	BiSS-C: driver error
ERR 320	BiSS-C: driver acquisition timeout
ERR 321	BiSS-C: driver is occupied
ERR 322	BiSS-C: request CRC error
ERR 324	HIPERFACE data error. Use HSAVE 1.
ERR 325	Predefined and set automatically
ERR 326	Not allowed in DDHD
ERR 328	No serial Enable in COMMODE=1

## 10.4 Fieldbus Status – LEDs

### 10.4.1 CANopen

Interfaces C5 and C6 (on **AF** models) share a LED that indicates the fieldbus status when communicating on a CANopen network:

- **Green:**
  - **Steadily lit** – Operational (OP) state
  - **Fast flashing** – Pre-Operational (PREOP) state
  - **Slow flashing** – Stopped state
- **Red:**
  - **Flashing** – Error

### 10.4.2 EtherCAT

Interfaces C5 and C6 (on **EB** and **EC** models) each have two LEDs that indicate the fieldbus status when communicating on an EtherCAT network:

- **Green:**
  - **Flashing** – Communication activity
  - **Not lit** – No communication activity
- **Orange:**
  - **Steadily lit** – Operational (OP) state
  - **Slow flashing** – Safe-Operation (SAFEOP) state
  - **Fast flashing** – Pre-Operational (PREOP) state
  - **Very fast flashing** – Bootstrap (BOOT) state
  - **Not lit** – Initial (INIT) state

## 10.5 Drive Status – 7-Segment Display

The 7-segment display provides various indications of drive status, such as operation modes, drive enable status, and fault conditions.

In general, the display uses the following conventions:

- **Decimal point** – Indicates the drive's Enable/Disable status; if displayed, the drive is enabled.
- **Steadily lit digit** – Indicates the operation mode (OPMODE) currently in effect.
- **Steadily lit letter** – Indicates a warning.
- **Flashing** – Indicates a fault.
- **Sequential display of letters and digits** – Indicates a fault, with some exceptions:
  - **A t 1** indicates motor phasing (MOTORSETUP) is in progress.
  - **L1, L2, L3, L4** indicate the state of software and hardware limit switches.
  - **S1** is a warning.
  - A digit flashing at half-second intervals during encoder initialization, indicates the operation mode (OPMODE) currently in effect.

In the event of concurrent faults, only one fault code is displayed on the 7-segment display. The display shows the code of the fault with the highest priority.

The functionality of the 7-segment display can be changed by means of the VarCom parameter DISPLAYMODE.

DISPLAYMODE=0	Serial communication operation modes are displayed. Default setting.
DISPLAYMODE=1	Fieldbus operation modes are displayed
DISPLAYMODE=2	Node IDs are displayed.



## 10.6 7-Segment Code Descriptions

The 7-segment code descriptions are presented here in alphanumerical order, in the following format:

<i>picture of code</i>	code in text	How displayed (e.g., flashing)
	<b>Definition</b>	Short name. Used in Flexi SUITE.
	<b>Type</b>	Specifies the type of status or fault indicated by the code: <b>Mode, Warning, Fault</b> or <b>Fatal fault</b> .
	<b>Active disable</b>	Indicates whether the Active Disable function (part of Disable mode) can be triggered by the fault.
	<b>Message #</b>	Fault/Warning/Error code displayed in Terminal.
	<b>Description</b>	Describes the status or fault indicated by the code.
	<b>Action required</b>	Describes the recommended steps for correcting the fault.

### -5 Motor Setup Failed



-5                      Displayed in sequence

<b>Definition</b>	Motor Setup Failed
<b>Type</b>	Fault
<b>Active disable</b>	No
<b>Message #</b>	FLT 44
<b>Description</b>	Motor Setup procedure failed. MOTORSETUPST will show the cause. This fault disables the drive.
<b>Action required</b>	Check phase and motor wiring. Make sure the correct feedback type is selected. Check MOTORSETUPST for hints.

**-1 Not Configured**

-1                      Displayed in sequence

<b>Definition</b>	Not Configured
<b>Type</b>	Fault
<b>Active disable</b>	Not applicable
<b>Message #</b>	FLT 12
<b>Description</b>	Drive configuration required. CONFIG is required after the value of any of certain parameters is modified. CONFIG is also required after certain parameters are sent to the drive, even if their value has not been changed.
<b>Action required</b>	Set drive parameters and/or and execute CONFIG.

**– Realtime Overload Warning**

–                      Lit steadily

<b>Definition</b>	Realtime Overload Warning
<b>Type</b>	Warning
<b>Active disable</b>	Not Applicable
<b>Message #</b>	WRN 36
<b>Description</b>	Drive has detected that CPU is close to its computational limit.
<b>Action required</b>	

**– Realtime Overload Fault**

–                      Flashing

<b>Definition</b>	Realtime Overload Fault
<b>Type</b>	Fault
<b>Active disable</b>	No
<b>Message #</b>	FLT 89
<b>Description</b>	CPU has exceeded its computational limit. Realtime execution takes longer than 31.25 $\mu$ s. This fault disables the drive.
<b>Action required</b>	Contact Technical Support

≡ [3 bars] **Watchdog Fault**



≡ [3 bars]      Flashing

<b>Definition</b>	Watchdog Fault
<b>Type</b>	Fault
<b>Active disable</b>	No
<b>Message #</b>	FLT 38
<b>Description</b>	Generally occurs due to an unforeseen circumstance. The drive is inoperable until power is cycled.
<b>Action required</b>	Switch the drive off and on again. If the detected error persists, contact Technical Support.

**0 Serial Velocity Mode**



0      Lit steadily

<b>Definition</b>	Serial Velocity Mode 0 = drive disabled; 0. = drive enabled
<b>Type</b>	Mode
<b>Active disable</b>	Not applicable
<b>Message #</b>	Not applicable
<b>Description</b>	Not applicable
<b>Action required</b>	Not applicable

**1 Analog Velocity Mode**



1      Lit steadily

<b>Definition</b>	***
<b>Type</b>	Mode
<b>Active disable</b>	Not applicable
<b>Message #</b>	Not applicable
<b>Description</b>	Not applicable
<b>Action required</b>	Not applicable

## 2 Serial Current Mode



2 Lit steadily

<b>Definition</b>	Serial Current Mode 2 = drive disabled; 2. = drive enabled
<b>Type</b>	Mode
<b>Active disable</b>	Not applicable
<b>Message #</b>	Not applicable
<b>Description</b>	Not applicable
<b>Action required</b>	Not applicable

## 3 Analog Current Mode



3 Lit steadily

<b>Definition</b>	Analog Current Mode 3 = drive disabled; 3. = drive enabled
<b>Type</b>	Mode
<b>Active disable</b>	Not applicable
<b>Message #</b>	Not applicable
<b>Description</b>	Not applicable
<b>Action required</b>	Not applicable

## 4 Gearing Mode



4 Lit steadily

<b>Definition</b>	Gearing Mode 4 = drive disabled; 4. = drive enabled
<b>Type</b>	Mode
<b>Active disable</b>	Not applicable
<b>Message #</b>	Not applicable
<b>Description</b>	Not applicable
<b>Action required</b>	Not applicable

## 8 Profile Position Mode



8 Lit steadily

<b>Definition</b>	Profile Position Mode 8 = drive disabled; 8. = drive enabled
<b>Type</b>	Mode
<b>Active disable</b>	Not applicable
<b>Message #</b>	Not applicable
<b>Description</b>	Not applicable
<b>Action required</b>	Not applicable

## 8. Hardware Ember Switch Activated



8. All segments of the LED display light up momentarily

<b>Definition</b>	Hardware Ember Switch Activated
<b>Type</b>	Not applicable
<b>Active disable</b>	Not applicable
<b>Message #</b>	Not applicable
<b>Description</b>	All segments of the LED display light up when the Hardware Ember switch is activated. Pressing the switch sets the drive to serial communication Boot-Up Mode.
<b>Action required</b>	Not applicable

## A4 CAN Supply Fault



A4 Displayed in sequence

<b>Definition</b>	CAN Supply Fault
<b>Type</b>	Fault
<b>Active disable</b>	Yes
<b>Message #</b>	FLT 32
<b>Description</b>	A problem with the internal voltage supply for the CAN bus. This fault disables the drive.
<b>Action required</b>	The drive probably needs repair. Contact Technical Support.

**At1 Motor Setup in Progress**

At1 Displayed in sequence

<b>Definition</b>	Motor Setup in Progress
<b>Type</b>	Mode
<b>Active disable</b>	Not applicable
<b>Message #</b>	Not Applicable
<b>Description</b>	The Motor Initialization procedure is in progress. If the procedure fails, the display will show "-5".
<b>Action required</b>	Not applicable

**b Multi-turn Encoder Battery Low Voltage**

b Lit steadily

<b>Definition</b>	Absolute Multi-turn Encoder Battery Low Voltage Warning
<b>Type</b>	Warning
<b>Active disable</b>	Not applicable
<b>Message #</b>	WRN 22
<b>Description</b>	The voltage level of the absolute multi-turn encoder backup battery has dropped below 3.15V.
<b>Action required</b>	Replace the battery as soon as possible. If the battery is replaced while drive power is on, encoder position information is retained. If power to the battery is shut off before the battery is replaced, issue the command MTTURNRESET to reset the multi-turn position after battery power is restored.

**b Drive Locked**

b Flashing

<b>Definition</b>	Drive Locked
<b>Type</b>	Fatal fault
<b>Active disable</b>	Not applicable
<b>Message #</b>	FLT 1
<b>Description</b>	Security code and key do not match. Drive cannot be enabled.
<b>Action required</b>	Contact Technical Support.

**b1 PLL Synchronization Failed**

b1                      Displayed in sequence

<b>Definition</b>	PLL (Phase-Locked Loop) Synchronization Failed
<b>Type</b>	Fault
<b>Active disable</b>	No
<b>Message #</b>	FLT 48
<b>Description</b>	Controller synchronization signal is missing or not stable. The fault is detected only when synchronization is enabled by SYNCSOURCE command. This fault disables the drive.
<b>Action required</b>	Check for controller synchronization signal. Check the cable connection and wiring.

**c Regen Resistor Overload**

c                              Lit steadily

<b>Definition</b>	Regen Resistor Overload
<b>Type</b>	Warning
<b>Active disable</b>	Not Applicable
<b>Message #</b>	WRN 34
<b>Description</b>	Regeneration resistor is overloaded.
<b>Action required</b>	

**C1 CAN Heartbeat Lost**

C1                              Displayed in sequence

<b>Definition</b>	CAN Heartbeat Lost
<b>Type</b>	Fault
<b>Active disable</b>	Yes
<b>Message #</b>	FLT 50
<b>Description</b>	Drive detected disconnection between CAN master and drive. This fault disables the drive.
<b>Action required</b>	Reconnect master and slave, and power cycle the drive.

**e Parameter Memory Checksum Failure**

e Flashing

<b>Definition</b>	Parameter Memory Checksum Failure
<b>Type</b>	Fault
<b>Active disable</b>	Not applicable
<b>Message #</b>	FLT 2
<b>Description</b>	The non-volatile memory used to store drive parameters is empty or the data is corrupted. May occur during power off if SAVE operation has not completed.
<b>Action required</b>	Reconfigure the drive, or download the parameter set, and save the parameters. If problem persists, contact Technical Support.

**E Ember Mode**

E Lit steadily

<b>Definition</b>	Ember Mode
<b>Type</b>	Mode
<b>Active disable</b>	Not applicable
<b>Message #</b>	Not Applicable
<b>Description</b>	Firmware is being updated in the drive.
<b>Action required</b>	Not applicable

**E Failure Writing to Flash Memory**

E Flashing

<b>Definition</b>	Failure Writing to Flash Memory
<b>Type</b>	Fatal fault
<b>Active disable</b>	Not applicable
<b>Message #</b>	FLT 13
<b>Description</b>	An internal problem accessing the flash memory. Drive cannot be enabled.
<b>Action required</b>	Contact Technical Support.



**e101 FPGA Config Failed**

e101                      Displayed in sequence

<b>Definition</b>	FPGA Config Failed
<b>Type</b>	Fatal fault
<b>Active disable</b>	Not applicable
<b>Message #</b>	FLT 5
<b>Description</b>	The code for the FPGA did not load. Drive cannot be enabled.
<b>Action required</b>	Contact Technical Support.

**e105 Self Test Failed**

e105                      Displayed in sequence

<b>Definition</b>	Self Test Failed
<b>Type</b>	Fatal fault
<b>Active disable</b>	Not applicable
<b>Message #</b>	FLT 33
<b>Description</b>	The power-up self test failed. Drive cannot be enabled.
<b>Action required</b>	Contact Technical Support.

**e106 Control EEPROM Fault**

e106                      Displayed in sequence

<b>Definition</b>	Control EEPROM Fault
<b>Type</b>	Fatal fault
<b>Active disable</b>	Not applicable
<b>Message #</b>	FLT 6
<b>Description</b>	A problem accessing the EEPROM on the control board. Drive cannot be enabled.
<b>Action required</b>	Contact Technical Support.

**e107 Power EEPROM Fault**

e107                      Displayed in sequence

<b>Definition</b>	Power EEPROM Fault
<b>Type</b>	Fatal fault
<b>Active disable</b>	Not applicable
<b>Message #</b>	FLT 7
<b>Description</b>	A problem accessing the EEPROM on the power board. Drive cannot be enabled.
<b>Action required</b>	Contact Technical Support.

**e108 Vbus Measure Circuit Failed**

e108                      Displayed in sequence

<b>Definition</b>	Vbus Measure Circuit Failed
<b>Type</b>	Fault
<b>Active disable</b>	Yes
<b>Message #</b>	FLT 8
<b>Description</b>	A failure occurred in the circuit that measures bus voltage. This fault disables the drive.
<b>Action required</b>	Reset faults. If the fault persists, the drive probably needs repair. Contact Technical Support.

**e109 Current-Sensors Offset Invalid**

e109                      Displayed in sequence

<b>Definition</b>	Current-Sensors Offset Invalid
<b>Type</b>	Fault
<b>Active disable</b>	No
<b>Message #</b>	FLT 43
<b>Description</b>	The calculated offsets for the current sensors are out of range. This fault disables the drive.
<b>Action required</b>	Reset faults. If the fault persists, the drive probably needs repair. Contact Technical Support.

**e120 FPGA Version Mismatch**

e120                      Displayed in sequence

<b>Definition</b>	FPGA Version Mismatch
<b>Type</b>	Fault
<b>Active disable</b>	Yes
<b>Message #</b>	FLT 47
<b>Description</b>	FPGA version does not match the firmware version. This fault disables the drive.
<b>Action required</b>	Update either FPGA version or drive version.

**e121 Internal Error**

e121                      Displayed in sequence

<b>Definition</b>	Internal Error
<b>Type</b>	Fault
<b>Active disable</b>	No
<b>Message #</b>	FLT 70
<b>Description</b>	Internal error due to an endless while loop or a numerical issue. This fault disables the drive.
<b>Action required</b>	Contact Technical Support.

**e123 Motor Plate Read Failed**

e123                      Displayed in sequence

<b>Definition</b>	Motor Plate Read Failed
<b>Type</b>	Fault
<b>Active disable</b>	Yes
<b>Message #</b>	FLT 85
<b>Description</b>	Motor type nameplate data cannot be read. This fault disables the drive.
<b>Action required</b>	Reconnect the feedback device. Make sure the motor type nameplate data is present.

**e124 SAVE and Power Cycle Required**

e124                      Displayed in sequence

<b>Definition</b>	SAVE and Power Cycle Required
<b>Type</b>	Fault
<b>Active disable</b>	Yes
<b>Message #</b>	FLT 86
<b>Description</b>	Parameter was changed, and requires SAVE and power cycle to take effect. This fault disables the drive.
<b>Action required</b>	SAVE and then cycle power to the drive.

**e125 Fieldbus Version Mismatch**

e125                      Displayed in sequence

<b>Definition</b>	Fieldbus Version Mismatch
<b>Type</b>	Fault
<b>Active disable</b>	Yes
<b>Message #</b>	FLT 93
<b>Description</b>	EtherCAT - the Microblaze version does not match the version specified by drive. This fault disables the drive.
<b>Action required</b>	Make sure the correct version has been downloaded to the drive.

**e126 ESI Version Mismatch**

e126                      Displayed in sequence

<b>Definition</b>	ESI Version Mismatch
<b>Type</b>	Fault
<b>Active disable</b>	Yes
<b>Message #</b>	FLT 94
<b>Description</b>	EtherCAT - the ESI version does not match the version specified by drive. This fault disables the drive.
<b>Action required</b>	Make sure the correct version has been downloaded to the drive.

**e127 Digital Output Over-Current Fault**

e127                      Displayed in sequence

<b>Definition</b>	Digital Output Over-Current Detected
<b>Type</b>	Fault
<b>Active disable</b>	Yes
<b>Message #</b>	FLT 96
<b>Description</b>	Over-current detected on one of the digital outputs. This fault disables the drive.
<b>Action required</b>	Verify correct wiring of the digital outputs. Make sure the output circuit is not shorted.

**e129 Feedback Type Auto-Detect Failed**

e129                      Displayed in sequence

<b>Definition</b>	Feedback type auto-detection failed.
<b>Type</b>	Fault
<b>Active disable</b>	Not Applicable
<b>Message #</b>	FLT 106
<b>Description</b>	Automatic detection of feedback type on power-up failed because neither sensAR nor HIPERFACE feedback device was detected. Feedback device is either disconnected or a different type. This fault disables the drive.
<b>Action required</b>	Verify the connection. Manually configure the actual type of feedback.

**e130 EnDat Excessive Resolution Fault**

e130                      Displayed in sequence

<b>Definition</b>	The EnDat encoder in-turn resolution detected during initialization exceeds 32 bits.
<b>Type</b>	Fault
<b>Active disable</b>	Not Applicable
<b>Message #</b>	FLT 107
<b>Description</b>	EnDat high resolution feedback cannot be handled by the drive. This fault disables the drive.
<b>Action required</b>	

**e131 MOTORNAME/MTP Data Mismatch**

e131                      Displayed in sequence

<b>Definition</b>	MOTORNAME and MTP data are not compatible.
<b>Type</b>	Fault
<b>Active disable</b>	Not Applicable
<b>Message #</b>	FLT 108
<b>Description</b>	Drive may have been configured previously for another, different motor. This fault disables the drive.
<b>Action required</b>	Clear MOTORNAME and clear faults. Perform tuning with parameters for the connected motor.

**e132 Firmware Version is Not Supported by this Drive**

e132                      Displayed in sequence

<b>Definition</b>	The drive firmware is not supported on this drive model.
<b>Type</b>	Fault
<b>Active disable</b>	Not Applicable
<b>Message #</b>	FLT 109
<b>Description</b>	Firmware version higher than 1.44.X cannot run on this drive. This fault disables the drive.
<b>Action required</b>	Download a compatible firmware version to the drive.

**e134 ESI Vendor Mismatch**



e134                      Displayed in sequence

<b>Definition</b>	On EtherCAT. The ESI vendor data does not match the data specified by the drive.
<b>Type</b>	Fault
<b>Active disable</b>	Yes
<b>Message #</b>	FLT 110
<b>Description</b>	Drive may have been configured previously for another, different motor. This fault disables the drive.
<b>Action required</b>	Make sure the correct vendor data is downloaded to drive.

**F Drive Foldback Warning  
Motor Foldback Warning**



F                              Lit steadily

<b>Definition</b>	Drive Foldback Warning Motor Foldback Warning
<b>Type</b>	Warning
<b>Active disable</b>	Not Applicable
<b>Message #</b>	WRN 2 WRN 3
<b>Description</b>	Drive foldback current dropped below the drive foldback current warning threshold (MIFOLDWTHRESH). Or, motor foldback current dropped below the motor foldback current warning threshold (IFOLDWTHRESH).
<b>Action required</b>	Check the drive-motor sizing. This warning can occur if the drive is under-sized (under-powered) for the application.

**F1 Drive Foldback**

F1                      Displayed in sequence

<b>Definition</b>	Drive Foldback
<b>Type</b>	Fault
<b>Active disable</b>	Yes
<b>Message #</b>	FLT 16
<b>Description</b>	Drive average current exceeds rated drive continuous current. It occurs after the Foldback warning has occurred.
<b>Action required</b>	Check motor-drive sizing. This fault can occur if the drive is under-sized (under-powered) for the application. Check that the commutation angle is correct (i.e., commutation is balanced).

**F2 Motor Foldback**

F2                      Displayed in sequence

<b>Definition</b>	Motor Foldback
<b>Type</b>	Fault
<b>Active disable</b>	Yes
<b>Message #</b>	FLT 17
<b>Description</b>	Motor average current exceeds rated motor continuous current. It occurs after the Foldback warning has occurred.
<b>Action required</b>	Check the drive-motor sizing. This fault can occur if the motor is under-sized (under-powered) for the application.



**F2H Pulse Train Frequency Too High**

F2H                      Displayed in sequence

<b>Definition</b>	Pulse Train Frequency Too High
<b>Type</b>	Fault
<b>Active disable</b>	Yes
<b>Message #</b>	FLT 76
<b>Description</b>	The external pulse train frequency has exceeded the maximum specified input frequency. This fault disables the drive.
<b>Action required</b>	Reduce the frequency of the gearing pulses commanded from the controller.

**F3 Stall Fault**

F3                              Displayed in sequence

<b>Definition</b>	Stall Fault
<b>Type</b>	Fault
<b>Active disable</b>	No
<b>Message #</b>	FLT 59
<b>Description</b>	A stall <b>condition</b> occurs when $[I > MICONT]$ and $[I > 0.9 \times ILIM]$ and $[V < STALLVEL]$ . A stall <b>fault</b> occurs whenever a stall condition persists for a duration greater than STALLTIME. This fault disables the drive.
<b>Action required</b>	Remove the stall condition, and take care to prevent stall conditions.

**Fb1 Fieldbus Velocity Limit Exceeded**

Fb1                      Displayed in sequence

<b>Definition</b>	Fieldbus Velocity Limit Exceeded
<b>Type</b>	Fault
<b>Active disable</b>	Yes
<b>Message #</b>	FLT 30
<b>Description</b>	A target position command from controller was rejected because it would cause motor to exceed the velocity limit. This fault disables the drive.
<b>Action required</b>	Enable the drive and send valid position commands.

**Fb2 Command Exceeds Acc/Dec Limits**

Fb2                      Displayed in sequence

<b>Definition</b>	Command Exceeds Acc/Dec Limits
<b>Type</b>	Fault
<b>Active disable</b>	Yes
<b>Message #</b>	FLT 66
<b>Description</b>	A new target position command from controller is about to cause the motor acceleration/deceleration to exceed the limits. Therefore the command is rejected and the drive faults. This fault disables the drive.
<b>Action required</b>	Enable the drive and send valid position commands.

**Fb3 Fieldbus Cable Disconnected**

Fb3                      Displayed in sequence

<b>Definition</b>	Fieldbus Cable Disconnected
<b>Type</b>	Fault
<b>Active disable</b>	Yes
<b>Message #</b>	FLT 65
<b>Description</b>	The connection between controller and drive was removed. This fault disables the drive.
<b>Action required</b>	Reestablish the connection between controller and drive.

**Fb4 Fieldbus Target Command Lost**

Fb4                      Displayed in sequence

<b>Definition</b>	Fieldbus Target Command Lost
<b>Type</b>	Fault
<b>Active disable</b>	Yes
<b>Message #</b>	FLT 69
<b>Description</b>	The fieldbus controller has not sent a target command in 3 consecutive instances. This fault disables the drive.
<b>Action required</b>	Clear the fault and allow the controller to send new commands.

**Fb7 CAN is in Bus-Off State**

Fb7                      Displayed in sequence

<b>Definition</b>	CAN is in Bus-Off State
<b>Type</b>	Fault
<b>Active disable</b>	Yes
<b>Message #</b>	FLT 88
<b>Description</b>	The drive has disconnected from the CAN bus due to communication errors, and is no longer sending/receiving communication packets. This fault disables the drive. This fault can be masked in object 1029h.
<b>Action required</b>	Check CAN cabling and verify the CAN network is functioning properly.

**Fb8 EtherCAT Packet Loss**

Fb8                      Displayed in sequence

<b>Definition</b>	EtherCAT Packet Loss
<b>Type</b>	Fault
<b>Active disable</b>	Yes
<b>Message #</b>	FLT 91
<b>Description</b>	EtherCAT packets have been lost. This fault disables the drive.
<b>Action required</b>	Make sure the EtherCAT master (controller) sends the packets within the time defined (by the master).

**Fb9 CAN/EtherCAT State Not Operational**

Fb9                      Displayed in sequence

<b>Definition</b>	CAN/EtherCAT State Not Operational
<b>Type</b>	Fault
<b>Active disable</b>	Yes
<b>Message #</b>	FLT 92
<b>Description</b>	Drive was enabled and in an operational state prior to receiving a command to move to a lower state of communication. This fault disables the drive.
<b>Action required</b>	Make sure the controller does not switch to a lower state of communication while the drive is enabled.

**H Motor Over-Temperature**

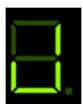
H                              Lit steadily

<b>Definition</b>	Motor Over-Temperature
<b>Type</b>	Warning
<b>Active disable</b>	Not Applicable
<b>Message #</b>	WRN 6
<b>Description</b>	Motor is overheated.
<b>Action required</b>	

**H Motor Over-Temperature**

H Flashing

<b>Definition</b>	Motor Over-Temperature
<b>Type</b>	Fault
<b>Active disable</b>	Yes
<b>Message #</b>	FLT 23
<b>Description</b>	Either the motor has overheated, or the drive is not set up correctly for the motor temperature sensor. This fault disables the drive.
<b>Action required</b>	Check that the drive is configured properly (using THERMODE, THERMTYPE, THERMTRIPLEVEL and THERMTIME), and that the motor temperature sensor is properly connected to the drive if needed. If the drive is configured and wired properly, check whether the motor is under-sized for the application.

**J Velocity Over-Speed Exceeded**

J Flashing

<b>Definition</b>	Velocity Over-Speed Exceeded
<b>Type</b>	Fault
<b>Active disable</b>	Yes
<b>Message #</b>	FLT 14
<b>Description</b>	Actual velocity exceeded 1.2 times the velocity limit. The velocity limit is set using VLIM. This fault disables the drive.
<b>Action required</b>	Check that VLIM is set to match the application requirements. Using velocity loop tuning, check for excessive overshoot.

**J1 Exceeded Maximum Position Error**

J1 Displayed in sequence

<b>Definition</b>	Exceeded Maximum Position Error
<b>Type</b>	Fault
<b>Active disable</b>	Yes
<b>Message #</b>	FLT 45
<b>Description</b>	The position error (PE) has exceeded the position error limit (PEMAX). This fault disables the drive.
<b>Action required</b>	Change drive tuning to improve position tracking, or increase PEMAX to allow a greater position error.

**J2 Exceeded Maximum Velocity Error**

J2 Displayed in sequence

<b>Definition</b>	Exceeded Maximum Velocity Error
<b>Type</b>	Fault
<b>Active disable</b>	Yes
<b>Message #</b>	FLT 67
<b>Description</b>	The velocity error (VE) has exceeded the velocity error limit (VEMAX). This fault disables the drive.
<b>Action required</b>	Change drive tuning to improve velocity tracking, or increase VEMAX to allow a greater velocity error.

**J3 Excessive PE Value**

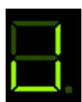
J3 Displayed in sequence

<b>Definition</b>	Excessive PE Value
<b>Type</b>	Fault
<b>Active disable</b>	No
<b>Message #</b>	FLT 87
<b>Description</b>	The position error (PE) has reached the software numerical limit. This fault disables the drive.
<b>Action required</b>	Check tuning.

**J4 Commutation Error (Motor Runaway) Condition Detected**

J4                      Displayed in sequence

<b>Definition</b>	Commutation Error (Motor Runaway) Condition Detected
<b>Type</b>	Fault
<b>Active disable</b>	No
<b>Message #</b>	FLT 77
<b>Description</b>	The motor moves in negative direction although the commanded current is positive. Commutation is incorrect. (Algebraic signs of actual current, acceleration and velocity do not match.) This fault disables the drive.
<b>Action required</b>	Correct MPHASE setting. Activate and improve the phase find process.

**J5 Secondary Feedback Position Mismatch**

J5                      Displayed in sequence

<b>Definition</b>	Secondary Feedback Position Mismatch
<b>Type</b>	Fault
<b>Active disable</b>	Yes
<b>Message #</b>	FLT 90
<b>Description</b>	Position deviation between motor and load is too great. This fault disables the drive.
<b>Action required</b>	Increase SFBPETHRESH, SFBPETIME, SFBPEMAX, or improve position tuning.

**L1 Hardware Positive Limit Switch is Open**

L1                      Displayed in sequence

<b>Definition</b>	Hardware Positive Limit Switch is Open
<b>Type</b>	Warning
<b>Active disable</b>	Not Applicable
<b>Message #</b>	WRN 15
<b>Description</b>	Positive hardware limit switch is activated.
<b>Action required</b>	



**L2 Hardware Negative Limit Switch is Open**

L2 Displayed in sequence

<b>Definition</b>	Hardware Negative Limit Switch is Open
<b>Type</b>	Warning
<b>Active disable</b>	Not Applicable
<b>Message #</b>	WRN 16
<b>Description</b>	Negative hardware limit switch is activated.
<b>Action required</b>	

**L3 Hardware Positive and Negative Limit Switches are Open**

L3 Displayed in sequence

<b>Definition</b>	Hardware Positive and Negative Limit Switches are Open
<b>Type</b>	Warning
<b>Active disable</b>	Not Applicable
<b>Message #</b>	WRN 17
<b>Description</b>	Positive and negative hardware limit switches are both activated.
<b>Action required</b>	

**L4 Software Positive Limit Switch is Tripped**

L4 Displayed in sequence

<b>Definition</b>	Software Positive Limit swItch is Tripped
<b>Type</b>	Warning
<b>Active disable</b>	Not Applicable
<b>Message #</b>	WRN 18
<b>Description</b>	Positive software limit switch is activated. PFB > POSLIMPOS and POSLIMMODE = 1
<b>Action required</b>	

**L5 Software Negative Limit Switch is Tripped**

L5                      Displayed in sequence

<b>Definition</b>	Software Negative Limit Switch is Tripped
<b>Type</b>	Warning
<b>Active disable</b>	Not Applicable
<b>Message #</b>	WRN 19
<b>Description</b>	Negative software limit switch is activated. PFB < POSLIMNEG and POSLIMMODE = 1
<b>Action required</b>	

**L6 Software Limit Switches are Tripped**

L6                      Displayed in sequence

<b>Definition</b>	Software Limit Switches are Tripped
<b>Type</b>	Warning
<b>Active disable</b>	Not Applicable
<b>Message #</b>	WRN 20
<b>Description</b>	Positive and negative software limit switches are activated. PFB > POSLIMPOS and PFB < POSLIMNEG and POSLIMMODE = 1
<b>Action required</b>	

**n STO Warning**

n                        Lit steadily

<b>Definition</b>	STO Warning
<b>Type</b>	Warning
<b>Active disable</b>	Not Applicable
<b>Message #</b>	WRN 1
<b>Description</b>	The STO signal is not connected when drive disabled.
<b>Action required</b>	Check that the STO connector (P1) is wired correctly.

**n STO Fault**

n Flashing

<b>Definition</b>	STO Fault
<b>Type</b>	Fault
<b>Active disable</b>	No
<b>Message #</b>	FLT 4
<b>Description</b>	The STO signal is not connected when drive enabled. This fault disables the drive.
<b>Action required</b>	Check that the STO connector (P1) is wired correctly.

**n1 Regen Over-Current**

n1 Displayed in sequence

<b>Definition</b>	Regen Over-Current
<b>Type</b>	Fault
<b>Active disable</b>	Yes
<b>Message #</b>	FLT 29
<b>Description</b>	The preset current limit for regen current has been exceeded. This fault disables the drive.
<b>Action required</b>	Increase the value of the regen resistor.

**n3 Emergency Stop Issued**

n3 Displayed in sequence

<b>Definition</b>	Emergency Stop Issued
<b>Type</b>	Fault
<b>Active disable</b>	Yes
<b>Message #</b>	FLT 57
<b>Description</b>	Input defined as Emergency Stop indicator has been activated. This fault disables the drive.
<b>Action required</b>	Turn off the input.

**n45 Power Brake Fault**

n45                      Displayed in sequence

<b>Definition</b>	Power Brake Fault
<b>Type</b>	Fault
<b>Active disable</b>	Yes
<b>Message #</b>	FLT 98
<b>Description</b>	A fault occurred on the power brake. This fault disables the drive.
<b>Action required</b>	Replace the motor brake.

**o Bus AC Supply Line Disconnected**

o                              Lit steadily

<b>Definition</b>	Bus AC Supply Line Disconnected
<b>Type</b>	Warning
<b>Active disable</b>	Not Applicable
<b>Message #</b>	WRN 32
<b>Description</b>	At least one phase of the main power for the bus supply is not connected.
<b>Action required</b>	

**o Over-Voltage**

o                              Flashing

<b>Definition</b>	Over-Voltage
<b>Type</b>	Fault
<b>Active disable</b>	No
<b>Message #</b>	FLT 9
<b>Description</b>	The bus voltage exceeded the maximum value. This fault disables the drive.
<b>Action required</b>	Check whether a regeneration resistor is required for the application.

**o15 Plus 15V Out of Range**

o15                      Displayed in sequence

<b>Definition</b>	Plus 15V Out of Range
<b>Type</b>	Fault
<b>Active disable</b>	Yes
<b>Message #</b>	FLT 36
<b>Description</b>	The internal +15 V supply is out of range. This fault disables the drive.
<b>Action required</b>	The drive probably needs repair. Contact Technical Support.

**o-15 Minus 15V Out of Range**

o-15                      Displayed in sequence

<b>Definition</b>	Minus 15V Out of Range
<b>Type</b>	Fault
<b>Active disable</b>	Yes
<b>Message #</b>	FLT 37
<b>Description</b>	The internal -15 V supply is out of range. This fault disables the drive.
<b>Action required</b>	The drive probably needs repair. Contact Technical Support.

**o5 5V Out of Range**

o5                              Displayed in sequence

<b>Definition</b>	5V Out of Range
<b>Type</b>	Fault
<b>Active disable</b>	Yes
<b>Message #</b>	FLT 52
<b>Description</b>	5V is low or powering off. This fault disables the drive.
<b>Action required</b>	May occur during power off. If it occurs under other conditions, contact Technical Support.

**o6 Logic AC Power Failure**

o6 Displayed in sequence

<b>Definition</b>	Logic AC Power Failure
<b>Type</b>	Fault
<b>Active disable</b>	Yes
<b>Message #</b>	FLT 72
<b>Description</b>	The main power for the logic supply is off. This fault disables the drive.
<b>Action required</b>	No action required. This is a normal response when logic power is turned off.

**o7 Bus AC Supply Line Disconnect**

o7 Displayed in sequence

<b>Definition</b>	Bus AC Supply Line Disconnect
<b>Type</b>	Fault
<b>Active disable</b>	Yes
<b>Message #</b>	FLT 78
<b>Description</b>	At least one phase of the main power for the bus supply is not connected. This fault disables the drive.
<b>Action required</b>	Check the connection of the bus AC supply. Make sure the supply is on.

**o8 Regen Resistor Overload**

o8 Displayed in sequence

<b>Definition</b>	Regen Resistor Overload
<b>Type</b>	Fault
<b>Active disable</b>	No
<b>Message #</b>	FLT 83
<b>Description</b>	The regen resistor load exceeds its allowed power. This fault disables the drive.
<b>Action required</b>	Check whether the regen resistor properties are suited to the application.

**o9 Digital Output Over-Current Fault**



o9                      Displayed in sequence

<b>Definition</b>	Digital output over-current fault.
<b>Type</b>	Fault
<b>Active disable</b>	No
<b>Message #</b>	FLT 105
<b>Description</b>	Over-current at the digital output has been detected. This fault disables the drive.
<b>Action required</b>	Check the digital output connections.

**P Over-Current**



P                              Flashing

<b>Definition</b>	Over-Current
<b>Type</b>	Fault
<b>Active disable</b>	No
<b>Message #</b>	FLT 3
<b>Description</b>	Over-current at the drive output has been detected. This fault disables the drive. The drive allows this fault to occur up to three times in succession. When the fault occurs for the fourth time, the drive forces a delay of 1 minute before it can be reenabled.
<b>Action required</b>	Check for a short circuit on the motor connection. Check for excessive overshoot in the current loop.

**P2 Unstable Current Loop**

P2                      Displayed in sequence

<b>Definition</b>	Unstable Current Loop
<b>Type</b>	Fault
<b>Active disable</b>	No
<b>Message #</b>	FLT 100
<b>Description</b>	An unexpected high current overshoot has been detected. This fault disables the drive.
<b>Action required</b>	Check and modify current controller settings.

**P3 High IQ Current Detected**

P3                      Displayed in sequence

<b>Definition</b>	High IQ Current Detected
<b>Type</b>	Fault
<b>Active disable</b>	No
<b>Message #</b>	FLT 104
<b>Description</b>	The detected IQ current is greater than 120% of ILIM. This fault disables the drive.
<b>Action required</b>	Check and modify current controller settings.



r

**Offset and/or Gain Adjustment Values Detected After SININIT**

r

Lit steadily

<b>Definition</b>	Offset and/or Gain Adjustment Values Detected After SININIT
<b>Type</b>	Warning
<b>Active disable</b>	Not applicable
<b>Message #</b>	WRN 27
<b>Description</b>	<p>Significant offset and/or gain adjustment values were detected after SININIT.</p> <p>The values that trigger this warning are half the value of those used to declare a fault. Although the system may continue to function, these values indicate the existence of a problem, which may worsen over time.</p>
<b>Action required</b>	<p>Check the encoder and associated hardware.</p> <p>These values suggest some degradation in either electronics (e.g., encoder, drive) or wiring (e.g., increased wire resistance, increased leakage between wires). The problem must be analyzed and repaired.</p>

r10

**Sine Feedback Communication Fail**

r10

Displayed in sequence

<b>Definition</b>	Sine Feedback Communication Fail
<b>Type</b>	Fault
<b>Active disable</b>	No
<b>Message #</b>	FLT 21
<b>Description</b>	<p>Communication problem between the drive and an EnDat or HIPERFACE encoder.</p> <p>This fault disables the drive.</p>
<b>Action required</b>	<p>Check that the data and clock signals to the EnDat or HIPERFACE encoder are connected properly. The cable must be shielded.</p>

**r14 Sine Encoder Quadrature Fault**

r14                      Displayed in sequence

<b>Definition</b>	Sine Encoder Quadrature Fault
<b>Type</b>	Fault
<b>Active disable</b>	No
<b>Message #</b>	FLT 24
<b>Description</b>	Mismatch between calculated and actual encoder quadrature information. This fault disables the drive.
<b>Action required</b>	Check the feedback device wiring. Make sure the correct encoder type (MENCTYPE) is selected.

**r15 Sin/Cos Calibration Invalid**

r15                      Displayed in sequence

<b>Definition</b>	Sin/Cos Calibration Invalid
<b>Type</b>	Fault
<b>Active disable</b>	No
<b>Message #</b>	FLT 25
<b>Description</b>	The sine/cosine calibration parameters are out of range. This fault is related to resolver and sine encoder feedback. This fault disables the drive.
<b>Action required</b>	Re-execute the sine/cosine calibration process.

**r16 Feedback 5V Over-Current**

r16                      Displayed in sequence

<b>Definition</b>	Feedback 5V Over-Current
<b>Type</b>	Fault
<b>Active disable</b>	No
<b>Message #</b>	FLT 26
<b>Description</b>	The current supplied by the drive on the 5V primary encoder supply has exceeded the preset current limit. The drive allows this fault to occur up to 3 times in succession. After 3 faults, the drive forces a delay of 1 minute before it can be reenabled. This fault disables the drive.
<b>Action required</b>	The FLEXI PRO can source a maximum current of 250 mA to the primary encoder. Check for a short-circuit at the encoder. Check if the encoder is drawing more than the current limit

**r17 Secondary Feedback Index Break**

r17                      Displayed in sequence

<b>Definition</b>	Secondary Feedback Index Break
<b>Type</b>	Fault
<b>Active disable</b>	Yes
<b>Message #</b>	FLT 27
<b>Description</b>	Secondary encoder index line not connected. This fault disables the drive.
<b>Action required</b>	Check whether the drive is configured for working with the index signal on the secondary encoder, and check if the index signal is connected.

**r18 Secondary Feedback A/B Line Break**

r18                      Displayed in sequence

<b>Definition</b>	Secondary Feedback A/B Line Break
<b>Type</b>	Fault
<b>Active disable</b>	Yes
<b>Message #</b>	FLT 28
<b>Description</b>	One of the secondary feedback signals is not connected. This fault disables the drive.
<b>Action required</b>	Check that all signals from the secondary encoder are properly connected to the drive.

**r19 Secondary Encoder 5V Over-Current**

r19                      Displayed in sequence

<b>Definition</b>	Secondary Encoder 5V Over-Current
<b>Type</b>	Fault
<b>Active disable</b>	Yes
<b>Message #</b>	FLT 31
<b>Description</b>	The preset current limit for current supplied by the drive on the 5 V secondary encoder supply has been exceeded. This fault disables the drive.
<b>Action required</b>	The FLEXI PRO can source a maximum current of 250 mA to the secondary encoder. Check for a short-circuit at the encoder. Check if the encoder is drawing more than the current limit.

**r20 Feedback Communication Error**

r20                      Displayed in sequence

<b>Definition</b>	Feedback Communication Error
<b>Type</b>	Fault
<b>Active disable</b>	No
<b>Message #</b>	FLT 34
<b>Description</b>	Communication with the feedback device did not initialize correctly. This fault disables the drive.
<b>Action required</b>	Check that the feedback device is wired correctly. Check that the correct encoder type (MENCTYPE) is selected.

**r21 Nikon Encoder Operational Fault**

r21                      Displayed in sequence

<b>Definition</b>	Nikon Encoder Operational Fault
<b>Type</b>	Fault
<b>Active disable</b>	No
<b>Message #</b>	FLT 35
<b>Description</b>	Communication with the Nikon feedback device did not initialize correctly. This fault disables the drive.
<b>Action required</b>	Check that the feedback device is wired correctly. Check that the correct encoder type (MENCTYPE) is selected.

**r23 Phase Find Failed**

r23                      Displayed in sequence

<b>Definition</b>	Phase Find Failed
<b>Type</b>	Fault
<b>Active disable</b>	No
<b>Message #</b>	FLT 41
<b>Description</b>	Commutation initialization has failed. This fault occurs in systems that do not have commutation information (e.g., Hall signals) in the motor feedback device. This fault disables the drive.
<b>Action required</b>	Check whether the motor feedback type and the phase-finding parameters are set correctly for the application.

**r24 Tamagawa Init Failed**

r24                      Displayed in sequence

<b>Definition</b>	Tamagawa Init Failed
<b>Type</b>	Fault
<b>Active disable</b>	No
<b>Message #</b>	FLT 42
<b>Description</b>	The initialization process with the Tamagawa feedback device has failed. This fault disables the drive.
<b>Action required</b>	Check that the wiring to the encoder is correct.

**r25 Pulse and Direction Input Line Break**

r25                      Displayed in sequence

<b>Definition</b>	Pulse and Direction Input Line Break
<b>Type</b>	Fault
<b>Active disable</b>	Yes
<b>Message #</b>	FLT 46
<b>Description</b>	One of the Pulse & Direction signals is not connected. This fault disables the drive.
<b>Action required</b>	Check that all signals to the P&D inputs are properly connected to the drive.

**r26 Tamagawa Abs Operational Fault**

r26                      Displayed in sequence

<b>Definition</b>	Tamagawa Abs Operational Fault
<b>Type</b>	Fault
<b>Active disable</b>	No
<b>Message #</b>	FLT49
<b>Description</b>	Several faults are indicated by the feedback device and include one or more of the following: battery low/error, over-speed, counting error, multi-turn error. This fault disables the drive.
<b>Action required</b>	Check the battery voltage and feedback wiring. Make sure the motor did not move at a high velocity during encoder initialization.

**r27 Motor Phases Disconnected**

r27                      Displayed in sequence

<b>Definition</b>	Motor Phases Disconnected
<b>Type</b>	Fault
<b>Active disable</b>	Yes
<b>Message #</b>	FLT 51
<b>Description</b>	One of the motor phases is disconnected. The current of one of the motor phases is effectively zero for more than 160 electrical degrees while the current command is greater than 100. This fault disables the drive.
<b>Action required</b>	Check the wiring of the motor phases.

**r28 Resolver Initialization Failed**

r28                      Displayed in sequence

<b>Definition</b>	Resolver Initialization Failed
<b>Type</b>	Fault
<b>Active disable</b>	No
<b>Message #</b>	FLT 55
<b>Description</b>	The drive could not detect the proper gain setting or sampling point for the sine/cosine signals. This fault disables the drive.
<b>Action required</b>	Check resolver wiring and gain value.

**r29 Multi-turn Encoder Battery Low Voltage**

r29                      Displayed in sequence

<b>Definition</b>	Absolute Multi-turn Encoder Battery Low Voltage Fault
<b>Type</b>	Fault
<b>Active disable</b>	No
<b>Message #</b>	FLT 56
<b>Description</b>	The voltage level of the absolute multi-turn encoder backup battery has dropped below 3.0V. This fault disables the drive.
<b>Action required</b>	Replace the encoder battery. If battery power is cut off before the battery is replaced, issue the command MTURNRESET to reset the multi-turn position after battery power is restored.



**r32 Endat2X Feedback Fault**

r32                      Displayed in sequence

<b>Definition</b>	Endat2X Feedback Fault
<b>Type</b>	Fault
<b>Active disable</b>	No
<b>Message #</b>	FLT 58
<b>Description</b>	CRC error occurred while drive was communicating with EnDat encoder. Also caused by EnDat encoder setting Alarm bit/s to indicate an encoder problem. This fault disables the drive.
<b>Action required</b>	Reset the encoder including encoder power off.

**r33 Custom Absolute Encoder Operational Fault**

r33                      Displayed in sequence

<b>Definition</b>	Custom Absolute Encoder Internal Faults
<b>Type</b>	Fault
<b>Active disable</b>	No
<b>Message #</b>	FLT 95
<b>Description</b>	Several possible issues are indicated by this feedback device fault: battery low or error; over-speed; counting error; multi-turn error. This fault disables the drive.
<b>Action required</b>	Check the battery voltage and feedback wiring. Make sure the motor did not move at a high velocity during encoder initialization.

**r34 PFB Off Checksum Invalid**

r34                      Displayed in sequence

<b>Definition</b>	PFB Off Checksum Invalid
<b>Type</b>	Fault
<b>Active disable</b>	No
<b>Message #</b>	FLT 60
<b>Description</b>	The calculated checksum of the PFB backup data does not match the expected checksum. This fault disables the drive.
<b>Action required</b>	If required by the application, home the machine.

**r35 PFB Off Data Mismatch**

r35                      Displayed in sequence

<b>Definition</b>	PFB Off Data Mismatch
<b>Type</b>	Fault
<b>Active disable</b>	No
<b>Message #</b>	FLT 61
<b>Description</b>	Multi-turn data of the PFB cannot be restored due to axis movement. This fault disables the drive.
<b>Action required</b>	If required by the application, home the machine.

**r36 No PFB Off Data**

r36                      Displayed in sequence

<b>Definition</b>	No PFB Off Data
<b>Type</b>	Fault
<b>Active disable</b>	No
<b>Message #</b>	FLT 62
<b>Description</b>	PFB backup memory is empty. This fault disables the drive.
<b>Action required</b>	If required by the application, home the machine.

**r37 Encoder Phase Error**

r37                      Displayed in sequence

<b>Definition</b>	Encoder Phase Error
<b>Type</b>	Fault
<b>Active disable</b>	No
<b>Message #</b>	FLT 68
<b>Description</b>	In normal incremental encoder operation, quadrature inputs A and B are 90 degrees out of phase. The phase error occurs when edge transition is detected simultaneously on the A and B signals. This fault disables the drive. This fault disables the drive.
<b>Action required</b>	Set MENCAQBFILT to 0 to remove the filter on A and B signals. If problem persists, it may be due to a faulty encoder.

**r38 Differential Halls Line Break**

r38                      Displayed in sequence

<b>Definition</b>	Differential Halls Line Break
<b>Type</b>	Fault
<b>Active disable</b>	No
<b>Message #</b>	FLT 71
<b>Description</b>	Line break in differential Hall sensors. This fault disables the drive.
<b>Action required</b>	Make sure HALLSTYPE matches the Hall sensors in use (single-ended or differential). Check whether all signals from the differential Hall sensors are properly connected to the drive.

**r39 AqB Commutation Fault**

r39                      Displayed in sequence

<b>Definition</b>	AqB Commutation Fault
<b>Type</b>	Fault
<b>Active disable</b>	Yes
<b>Message #</b>	FLT 80
<b>Description</b>	<p>Loss of commutation/encoder counts for AqB encoder. The index signal serves as a reference position for detecting loss of commutation/pulses. The AqB encoder counter is compared at different index positions. Between index position captures the count must be exactly MENCRESx4 (or 0 counts if moved back to same index location).</p> <p>This fault disables the drive.</p>
<b>Action required</b>	<p>If a fault occurs shortly after motion begins, check MENCRES settings.</p> <p>If a fault occurs after some time it is likely due to EMI noise. Improve the installation. Make sure ground is connected. Make sure shield is connected on feedback and motor cables.</p>

**r4 A/B Line Break**

r4                              Displayed in sequence

<b>Definition</b>	A/B Line Break
<b>Type</b>	Fault
<b>Active disable</b>	No
<b>Message #</b>	FLT 18
<b>Description</b>	<p>One of the primary feedback signals is not connected. This fault occurs in incremental encoder, resolver and sine encoder feedback types.</p> <p>This fault disables the drive.</p>
<b>Action required</b>	<p>Refer to the section <i>Sine Encoder and Resolver Diagnostics</i>.</p> <p>Check whether all signals from the primary feedback device are properly connected to the drive.</p>

**r40 SensAR Encoder Fault**

r40                      Displayed in sequence

<b>Definition</b>	SensAR Encoder Fault
<b>Type</b>	Fault
<b>Active disable</b>	No
<b>Message #</b>	FLT 82
<b>Description</b>	The drive has detected an internal fault on the sensAR encoder through communication. This fault disables the drive.
<b>Action required</b>	Use command SRVSNSINFO to identify the fault.

**r41 Sankyo Absolute Encoder Fault**

r41                      Displayed in sequence

<b>Definition</b>	Sankyo Absolute Encoder Fault
<b>Type</b>	Fault
<b>Active disable</b>	Yes
<b>Message #</b>	FLT 99
<b>Description</b>	One or more faults are indicated by the feedback device, including: battery low or error, over-speed, counting error, multi-turn error. This fault disables the drive.
<b>Action required</b>	Check the battery voltage and feedback wiring. Make sure the motor did not move at a high velocity during encoder initialization.

**r42 BiSS-C Encoder Indicates an Internal Fault**

r42                      Displayed in sequence

<b>Definition</b>	BiSS-C encoder indicates an internal fault.
<b>Type</b>	Fault
<b>Active disable</b>	No
<b>Message #</b>	FLT 102
<b>Description</b>	This fault disables the drive.
<b>Action required</b>	Refer to the BiSS-C encoder manufacturer specific documentation.

**r43 HIPERFACE Data Error**

r43                      Displayed in sequence

<b>Definition</b>	HIPERFACE encoder data error.
<b>Type</b>	Fault
<b>Active disable</b>	No
<b>Message #</b>	FLT 103
<b>Description</b>	This fault disables the drive.
<b>Action required</b>	Enter the command HSAVE 1.

**r45 MENCZPOS Mismatch with Halls**

r45                      Displayed in sequence

<b>Definition</b>	MENCZPOS Does Not Match Halls
<b>Type</b>	Fault
<b>Active disable</b>	No
<b>Message #</b>	FLT 111
<b>Description</b>	<p>Either an incorrect MENCZPOS value was saved or the encoder has a different index location.</p> <p>The fault is declared when the difference between the electrical angle based on MENCZPOS and the electrical angle of the Hall sensors is greater than 30 degrees.</p> <p>This fault disables the drive.</p>
<b>Action required</b>	Run Motor Setup wizard and save the new value of MENCZPOS.

**r5 Index Line Break**

r5                      Displayed in sequence

<b>Definition</b>	Index Line Break
<b>Type</b>	Fault
<b>Active disable</b>	Yes
<b>Message #</b>	FLT 20
<b>Description</b>	Encoder index line is not connected. This fault disables the drive.
<b>Action required</b>	Check that the drive is configured for working with the index signal (using MENCTYPE), and check if the index signal is connected.

**r6 Invalid Halls**

r6                      Displayed in sequence

<b>Definition</b>	Invalid Halls
<b>Type</b>	Fault
<b>Active disable</b>	Yes
<b>Message #</b>	FLT 19
<b>Description</b>	The drive has detected either 000 or 111 state on the Hall feedback signals. This fault disables the drive.
<b>Action required</b>	Check that the Hall signals are all properly connected. While turning the motor, read the Halls state (using HALLS) to see which signal is not connected. If the feedback type is Tamagawa, check that the feedback wiring is correct

**r8 A/B Out of Range**

r8                      Displayed in sequence

<b>Definition</b>	A/B Out of Range
<b>Type</b>	Fault
<b>Active disable</b>	No
<b>Message #</b>	FLT 22
<b>Description</b>	Feedback analog signal is out of range. This fault is related to resolver and sine encoder feedback. The drive checks that the amplitudes of the sine and cosine signals are correct, based on the calculation $\sin^2 + \cos^2 = 1$ . This fault disables the drive.
<b>Action required</b>	Refer to the section Sine Encoder and Resolver Diagnostics. Check the amplitudes of the sine and cosine signals.

**r9 Encoder Simulation Frequency Too High**

r9                      Displayed in sequence

<b>Definition</b>	Encoder Simulation Frequency Too High
<b>Type</b>	Fault
<b>Active disable</b>	Yes
<b>Message #</b>	FLT 15
<b>Description</b>	The computed equivalent encoder output frequency exceeds the upper limit for this signal, which is 4 MHz. This fault disables the drive.
<b>Action required</b>	Check the parameters used for setting up the equivalent encoder output. If using a sine encoder, check the ENCOUTRES parameter settings.



**S1 Cannot Use SFBTYPE 1 with Analog OPMODE**



S1                      Displayed in sequence

<b>Definition</b>	Cannot Use SFBTYPE 1 with Analog OPMODE
<b>Type</b>	Warning
<b>Active disable</b>	Not Applicable
<b>Message #</b>	WRN 37
<b>Description</b>	Cannot use the specified type of secondary feedback with analog operation modes (i.e., OPMODE 1, OPMODE 3)
<b>Action required</b>	

**t Power Stage Over-Temperature  
Control Board Over-Temperature  
Integrated Power Module Over-Temperature**



t                              Lit steadily

<b>Definition</b>	Power Stage Over-Temperature Control Board Over-Temperature Integrated Power Module Over-Temperature
<b>Type</b>	Warning
<b>Active disable</b>	Not Applicable
<b>Message #</b>	WRN 5 WRN 9 WRN 38
<b>Description</b>	The temperature on the power board and/or on the control board and/or the power module (IPM) has exceeded the preset limit.
<b>Action required</b>	Check if the ambient temperature exceeds the drive specification. Otherwise contact Technical Support.

**t1 Power Stage Over-Temperature**

t1                      Displayed in sequence

<b>Definition</b>	Power Stage Over-Temperature
<b>Type</b>	Fault
<b>Active disable</b>	Yes
<b>Message #</b>	FLT 10
<b>Description</b>	The temperature on the power board has exceeded the preset limit. This fault disables the drive.
<b>Action required</b>	Check if the ambient temperature exceeds the drive specification. Otherwise contact Technical Support.

**t2 Integrated Power Module Over-Temperature**

t2                      Displayed in sequence

<b>Definition</b>	Integrated Power Module Over-Temperature
<b>Type</b>	Fault
<b>Active disable</b>	Yes
<b>Message #</b>	FLT 39
<b>Description</b>	The temperature within the integrated power module has exceeded the preset limit. This fault disables the drive.
<b>Action required</b>	Check if the ambient temperature exceeds the drive specification. Otherwise contact Technical Support.

**t3 Control Board Over-Temperature**

t3                      Displayed in sequence

<b>Definition</b>	Control Board Over-Temperature
<b>Type</b>	Fault
<b>Active disable</b>	Yes
<b>Message #</b>	FLT 40
<b>Description</b>	The temperature on the control board has exceeded the preset limit. This fault disables the drive.
<b>Action required</b>	Check if the ambient temperature exceeds the drive specification. Otherwise contact Technical Support.

**t4 Temperature Sensor Failure**

t4                      Displayed in sequence

<b>Definition</b>	Temperature Sensor Failure
<b>Type</b>	Fault
<b>Active disable</b>	Yes
<b>Message #</b>	FLT 73
<b>Description</b>	Temperature sensor malfunction. This fault disables the drive.
<b>Action required</b>	Cycle power. If problem persists, contact Technical Support.

**u Under-Voltage**

u Lit steadily

<b>Definition</b>	Under-Voltage
<b>Type</b>	Warning
<b>Active disable</b>	Not Applicable
<b>Message #</b>	WRN 4
<b>Description</b>	The bus voltage is below the minimum value. If the value of variable UVMODE is 1 or 2, and the drive is enabled, an under-voltage warning is issued.
<b>Action required</b>	Check that the main AC voltage supply is connected to the drive and is switched on. The under-voltage limit can be read with the UVTHRESH command.

**u Under-Voltage**

u Flashing

<b>Definition</b>	Under-Voltage
<b>Type</b>	Fault
<b>Active disable</b>	Yes
<b>Message #</b>	FLT 11
<b>Description</b>	The bus voltage is below the minimum value. If the value of variable UVMODE is 3, and the drive is enabled, an under-voltage fault is issued. This fault disables the drive.
<b>Action required</b>	Check that the main AC voltage supply is connected to the drive and is switched on. The under-voltage limit can be read with the UVTHRESH command.

# 11 FLEXI PRO Accessories

## 11.1 Line Filters

The manufacturers and part numbers of line filters recommended for the FLEXI PRO are listed in the following tables.

**Table 11-1. Recommended Line Filters**

	<b>FLEXI PRO-1D5-2A FLEXI PRO-003-2A</b>	<b>FLEXI PRO-4D5-2A FLEXI PRO-006-2A</b>	<b>FLEXI PRO-4D5-2A FLEXI PRO-006-2A</b>
<b>Mains</b>	<b>1-Phase</b>	<b>1-Phase</b>	<b>3-Phase</b>
Manufacturer Part Number	High & Low 04SS4-2NC2-x-Q	LCR 0923.01021.00	LCR 096B.01001.00
Manufacturer Part Number	LCR 055M.80601.00	LCR 092.01023.00	Schaffner FN3258
Manufacturer Part Number	LCR 092.00423.00	LCR 055.81011.00	
Manufacturer Part Number	Schaffner FN2070	Schaffner FN2070	
	<b>FLEXI PRO-008-2A FLEXI PRO-010-2A FLEXI PRO-013-2A</b>	<b>FLEXI PRO-008-2A FLEXI PRO-010-2A FLEXI PRO-013-2A</b>	<b>FLEXI PRO-020-2A FLEXI PRO-024-2A</b>
<b>Mains</b>	<b>1-Phase</b>	<b>3-Phase</b>	<b>3-Phase</b>
Manufacturer Part Number	High & Low 20SS4-2KC3-Q	LCR 096B.02001.00	LCR 096.03501.00
Manufacturer Part Number	LCR 0923.02021.00	LCR 097.01601.00	LCR 096B.03001.00
Manufacturer Part Number	LCR 092.02023.00	Schaffner FN3258	Schaffner FN3258
Manufacturer Part Number	High & Low 20SS4-2JC3-Q		
	<b>FLEXI PRO-003-4A FLEXI PRO-006-4A</b>	<b>FLEXI PRO-012-4A</b>	<b>FLEXI PRO-020-4A FLEXI PRO-024-4A</b>
<b>Mains</b>	<b>3-Phase</b>	<b>3-Phase</b>	<b>3-Phase</b>
Manufacturer Part Number	LCR 096B.01001.00	LCR 096B.02001.00	LCR 096.03501.00
Manufacturer Part Number	CORCOM 25FCD10	CORCOM 25FCD10	LCR 096B.03001.00

## 11.2 Regeneration Resistors

Resistance values (Ohms,  $\Omega$ ) are defined by the FLEXI PRO servo drive. Required power is defined by the application. Therefore, each drive has several regeneration resistor options.

The manufacturers and part numbers of regen resistors recommended for the FLEXI PRO are listed in the following tables.

Refer to *Regeneration* .

**Table 11-2. Recommended Regen Resistors for FLEXI PRO 120/240 VAC**

	<b>FLEXI PRO-1D5-2A FLEXI PRO-003-2A</b>	<b>FLEXI PRO-4D5-2A FLEXI PRO-006-2A FLEXI PRO-008-2A FLEXI PRO-010-2A FLEXI PRO-013-2A</b>	<b>FLEXI PRO-020-2A FLEXI PRO-024-2A</b>
<b>Power (W)</b>	<b>Resistance 100 <math>\Omega</math></b>	<b>Resistance 33 <math>\Omega</math></b>	<b>Resistance 15 <math>\Omega</math></b>
150	ISOTEK ULH150 N 100 K FL500	ISOTEK ULH150 N 33 K FL500	ISOTEK ULH150 N 15 K FL500
300	ISOTEK ULH300 N 100 K FL500	ISOTEK ULH300 N 33 K FL500	ISOTEK ULH150 N 15 K FL500
600	FRIZLEN FZECU400x65-100	FRIZLEN FZECU400x65-33	ISOTEK ULV600 N 15 K FL500
1000	X	ISOTEK ULV1000 N 33 K FL500	ISOTEK ULV1000 N 15 K FL500
2000	X	FRIZLEN FZZCU600x65-33	ISOTEK ULM2000 N 15 K
3000	X	FRIZLEN FGFKU3100602-33	FRIZLEN FGFKU3100602-15
4000	X	X	FRIZLEN FGFKU3100802-15

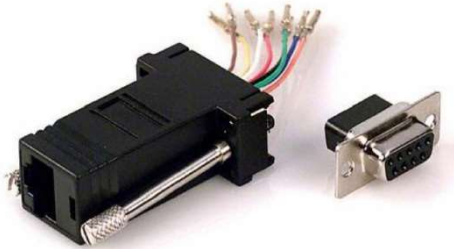
**Table 11-3. Recommended Regen Resistors for FLEXI PRO 400/480 VAC**

	<b>FLEXI PRO-003-4D FLEXI PRO-006-4D</b>	<b>FLEXI PRO-012-4B</b>	<b>FLEXI PRO-024-4C FLEXI PRO-030-4C</b>
<b>Power (W)</b>	<b>Resistance 47 <math>\Omega</math></b>	<b>Resistance 33 <math>\Omega</math></b>	<b>Resistance 12 <math>\Omega</math></b>
300	Use FLEXI PRO internal resistor (P3)	Use FLEXI PRO internal resistor (P3)	Use FLEXI PRO internal resistor (P3)
600	ISOTEK ULV600 N 47 K FL500	ISOTEK ULV600 N 33 K FL500	To be defined.
1000	ISOTEK ULV1000 N 47 K FL500	ISOTEK ULV1000 N 33 K FL500	To be defined.
2000	ISOTEK ULM2000 N 47 K	ISOTEK ULM2000 N 33 K	To be defined.
3000	FRIZLEN FGFKU3100602-47	FRIZLEN FGFKU3100602-33	To be defined.
4000	FRIZLEN FGFKU3100802-47	FRIZLEN FGFKU3100802-33	To be defined.

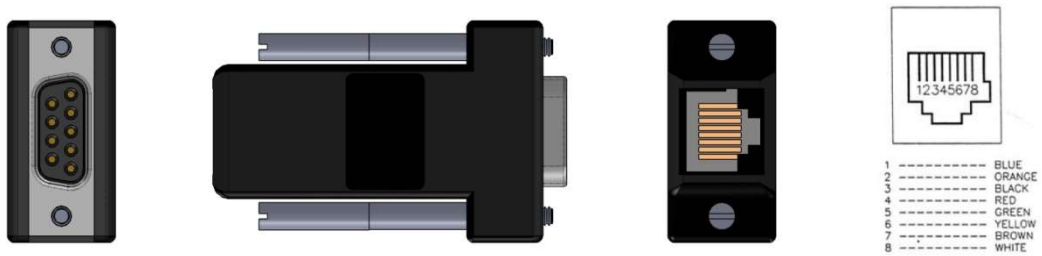
### 11.3 D9-RJ45 Adapter

Many PLC devices use D9 type interfaces for CAN connections.

To enable the connection of the FLEXI PRO RJ45 port to a D9 interface, Motor Power Company offers an adapter, as shown below.



**Figure 11-1. D9-RJ45 Adapter**



**Figure 11-2. D9-RJ45 Adapter Interfaces**

**Table 11-4. D9-RJ45 Adapter Wiring**

Function	FLEXI PRO RJ45 Pin	D9 Connector Pin
CAN High	1	7
CAN Low	2	2
Functional Ground	3	3
CAN Shield	6	5
Functional Ground	7	6

**FLEXI PRO Servo Drive  
User Manual**